



**HAL**  
open science

**Implémentation et optimisation d'études de dégradation forcée en pré-développement pour l'amélioration du screening des formulations = Implementation and optimization of pre-development forced degradation studies for formulation screening improvement**

Florie Guillaumin

► **To cite this version:**

Florie Guillaumin. Implémentation et optimisation d'études de dégradation forcée en pré-développement pour l'amélioration du screening des formulations = Implementation and optimization of pre-development forced degradation studies for formulation screening improvement. Pharmaceutical sciences. 2010. dumas-00593124

**HAL Id: dumas-00593124**

**<https://dumas.ccsd.cnrs.fr/dumas-00593124>**

Submitted on 13 May 2011

**HAL** is a multi-disciplinary open access archive for the deposit and dissemination of scientific research documents, whether they are published or not. The documents may come from teaching and research institutions in France or abroad, or from public or private research centers.

L'archive ouverte pluridisciplinaire **HAL**, est destinée au dépôt et à la diffusion de documents scientifiques de niveau recherche, publiés ou non, émanant des établissements d'enseignement et de recherche français ou étrangers, des laboratoires publics ou privés.

UNIVERSITE JOSEPH FOURIER  
FACULTE DE PHARMACIE DE GRENOBLE

*Année: 2010*

IMPLEMENTATION ET OPTIMISATION D'ETUDES DE DEGRADATION  
FORCEE EN PRE-DEVELOPPEMENT POUR L'AMELIORATION DU  
SCREENING DES FORMULATIONS

IMPLEMENTATION AND OPTIMIZATION OF PRE-DEVELOPMENT  
FORCED DEGRADATION STUDIES FOR FORMULATIONS SCREENING  
IMPROVEMENT

THESE  
PRESENTEE POUR L'OBTENTION DU TITRE DE DOCTEUR EN PHARMACIE  
DIPLOME D'ETAT

***Florie GUILLAUMIN***

*Née le 14 Avril 1985  
A: Orléans*

THESE SOUTENUE PUBLIQUEMENT A LA FACULTE DE PHARMACIE DE GRENOBLE

Le: 10 décembre 2010

DEVANT LE JURY COMPOSE DE:

Président du jury: Mr AZIZ BAKRI

Directeur de thèse: Mr DIDIER HOARAU

Membres: Mme NAWEL KHALEF  
Mme CECILE ROUPIOZ

*La Faculté de Pharmacie de Grenoble n'entend donner aucune approbation ni improbation aux opinions émises dans les thèses; ces opinions sont considérées comme propres à leurs auteurs*



UFR  
DE PHARMACIE  
DE GRENOBLE

UNIVERSITE  
JOSEPH FOURIER  
SCIENCES. TECHNOLOGIE. SANTÉ.



UNIVERSITE JOSEPH FOURIER  
FACULTE DE PHARMACIE DE GRENOBLE  
Domaine de la Merci 38700 LA TRONCHE

Doyen de la Faculté : Mme le Professeur Renée GRILLOT  
Vice -Doyen et Directeur des Etudes : Mme Edwige NICOLLE

Année 2009-2010

**MAITRES DE CONFERENCES DE PHARMACIE (n = 32)**

ALDEBERT	Delphine	Parasitologie - Mycologie (L.A.P.M)
ALLENET	Benoît	Pharmacie Clinique (ThEMAS TIMC-IMAG / MCU-PH)
BATANDIER	Cécile	Nutrition et Physiologie (L.B.F.A)
BRETON	Jean	Biologie Moléculaire / Biochimie (L.C.I.B - LAN)
BRIANCON-MARJOLLET	Anne	Physiologie Pharmacologie (HP2)
BUDAYOVA SPANO	Monika	Biophysique (U.V.H.C.I)
CAVAILLES	Pierre	Biologie Cellulaire et génétique (L.A.P.M)
CHOISNARD	Luc	Pharmacotechnie (D.P.M)
DELETRAZ-DELPORTE	Martine	Droit Pharmaceutique
DEMEILLIERS	Christine	Biochimie (L.B.F.A.)
DURMORT-MEUNIER	Claire	Biotechnologies (I.B.S.)
GEZE	Annabelle	Pharmacotechnie (D.P.M.)
GERMI	Raphaële	Microbiologie (U.V.H.C.I. / MCU-PH)
GILLY	Catherine	Chimie Thérapeutique (D.P.M.)
GROSSET	Catherine	Chimie Analytique (D.P.M.)
GUIEU	Valérie	Chimie Analytique (D.P.M)
HININGER-FAVIER	Isabelle	Biochimie (L.B.F.A)
JOYEUX-FAURE	Marie	Physiologie -Pharmacologie (HP2)
KRIVOBOK	Serge	Biologie Végétale et Botanique (L.C.B.M)
MOUHAMADOU	Bello	Cryptogamie, Mycologie Générale (L.E.C.A)
MORAND	Jean-Marc	Chimie Thérapeutique (D.P.M.)
MELO DE LIMA	Christelle	Probabilités Biostatistiques (L.E.C.A)
NICOLLE	Edwige	Chimie Organique (D.P.M.)
PEUCHMAUR	Marine	Chimie Organique (D.P.M)
PINEL	Claudine	Parasitologie - Mycologie Médicale (CIB / MCU-PH)
RACHIDI	Walid	Biochimie (L.C.I.B)
RAVEL	Anne	Chimie Analytique (D.P.M.)
RAVELET	Corinne	Chimie Analytique (D.P.M.)
SOUARD	Florence	Pharmacognosie (D.P.M)
TARBOURIECH	Nicolas	Biophysique (U.V.H.C.I)
VANHAVERBEKE	Cécile	Chimie organique (D.P.M.)
VILLET	Annick	Chimie Analytique (VP Form Adjoint UJF, D.P.M.)

Mise à jour du 03/09/2009

1

DOMAINE DE LA MERCI - 38706 LA TRONCHE CEDEX - FRANCE - TELEPHONE +33 (0)4 76 63 71 00 - FAX +33 (0)4 76 63 71 70



UFR  
DE PHARMACIE  
DE GRENOBLE



**ENSEIGNANTS ANGLAIS (N = 3)**

COLLE Pierre Emmanuel	Maître de Conférence
FITE Andrée	Professeur Certifié
GOUBIER Laurence	Professeur Certifié

**ATER (N = 5)**

ATER	ELAZZOZI Samira	Pharmacie Galénique
ATER	SHEIKH HASSAN Amhed	Pharmacie Galénique
ATER	MAS Marie	Anglais Master ISM
ATER	ROSSI Caroline	Anglais Master ISM
ATER	SAPIN Emilie	Physiologie Pharmacologie

ATER : Attachés Temporaires d'Enseignement et de Recherches  
CHU : Centre Hospitalier Universitaire  
CIB : Centre d'Innovation en Biologie  
DPM : Département de Pharmacochimie Moléculaire  
HP2 : Hypoxie Physiopathologie Respiratoire et Cardiovasculaire  
IAB : Institut Albert Bonniot, Centre de Recherche « Oncogenèse et Ontogenèse »  
IBS : Institut de Biologie Structurale  
LAPM : Laboratoire Adaptation et Pathogenèse des Microorganismes  
LBFA : Laboratoire de Bioénergétique Fondamentale et Appliquée  
LCBM : Laboratoire Chimie et Biologie des Métaux  
LCIB : Laboratoire de Chimie Inorganique et Biologie  
LECA : Laboratoire d'Ecologie Alpine  
TIMC-IMAG : Laboratoire Technique de l'Imagerie, de la Modélisation et de Cognition  
UVHCI: Unit of Virus Host Cell Interactions



UFR  
DE PHARMACIE  
DE GRENOBLE



UNIVERSITE JOSEPH FOURIER  
FACULTE DE PHARMACIE DE GRENOBLE  
Domaine de la Merci 38700 LA TRONCHE

Doyen de la Faculté : Mme le Professeur Renée GRILLOT  
Vice-Doyen et Directeur des Etudes : Mme Edwige NICOLLE

Année 2009-2010

PROFESSEURS A L'UFR DE PHARMACIE (N=17)

BAKRI	Aziz	Pharmacie Galénique et Industrielle, Formulation et Procédés Pharmaceutiques (LR)
BOUMENDJEL	Ahcène	Chimie Organique (D.P.M.)
BURMEISTER	Wilhelm	Physique (U.V.H.C.I)
CALOP	Jean	Pharmacie Clinique (PU-PH)
DANEL	Vincent	Toxicologie (SMUR SAMU / PU-PH)
DECOUT	Jean-Luc	Chimie Inorganique (D.P.M.)
DROUET	Christian	Immunologie Médicale (GREPI – TIMC)
DROUET	Emmanuel	Microbiologie (U.V.H.C.I)
FAURE	Patrice	Biochimie (HP2 / PU-PH)
GODIN-RIBUOT	Diane	Physiologie – Pharmacologie (HP2)
GRILLOT	Renée	Parasitologie - Mycologie Médicale (Directeur UFR / LAPM, PU-PH)
LENORMAND	Jean Luc	Ingénierie Cellulaire, Biothérapies (Therex, TIMC)
PEYRIN	Eric	Chimie Analytique (D.P.M.)
SEVE	Michel	Biochimie - Biotechnologie (IAB, PU-PH)
RIBUOT	Christophe	Physiologie - Pharmacologie (HP2)
ROUSSEL	Anne-Marie	Biochimie Nutrition (L.B.F.A)
WOUESSIDJEWE	Denis	Pharmacotechnie (D.P.M.)

Mise à jour le 03/09/2009

DOMAINE DE LA MERCI - 38706 LA TRONCHE CEDEX - FRANCE - TELEPHONE +33 (0)4 76 63 71 00 - FAX +33 (0)4 76 63 71 70



UFR  
DE PHARMACIE  
DE GRENOBLE



**PROFESSEUR EMERITE (N=1)**

FAVIER

Alain

**PROFESSEURS ASSOCIES (PAST) (N=2)**

RIEU

TROULLER

Isabelle

Patrice

Qualitologie (Praticien Attaché - CHU)

Santé Publique (Praticien Hospitalier - CHU)

**PROFESSEUR AGREGE (PRAG) (N=1)**

GAUCHARD

Pierre Alexis

Chimie (D.P.M.)

CHU : Centre Hospitalier Universitaire

DPM : Département de Pharmacochimie Moléculaire

HP2 : Hypoxie Physiopathologie Respiratoire et Cardiovasculaire

IAB : Institut Albert Bonniot

LBFA : Laboratoire de Bioénergétique Fondamentale et Appliquée

LCIB : Laboratoire de Chimie Inorganique et Biologie

LR : Laboratoire des Radio pharmaceutiques

PAST : Professeur Associé à Temps Partiel

PRAG : Professeur Agrégé

UVHCI: Unit of Virus Host Cell Interactions

Mise à jour le 03/09/2009

DOMAINE DE LA MERCI - 38706 LA TRONCHE CEDEX - FRANCE - TELEPHONE +33 (0)4 76 63 71 00 - FAX +33 (0)4 76 63 71 70

## DEDICACES

A ma mère

Qui m'a toujours poussé à rechercher l'excellence et m'a appris la persévérance.

A mon frère et ma sœur

Qui m'ont montré la voie et m'ont accompagné par leurs conseils et leur soutien aux moments importants de ma vie.

A mes amies

Qui m'ont aidé à développer mon ouverture d'esprit. Merci d'avoir rendu mes années d'études inoubliables.

A Florian

Pour son amour et sa compréhension.

« Ouvre ta fenêtre sur le large monde »

Joseph Foussier

---

## REMERCIEMENTS

Ce travail a été réalisé au sein de la société Becton Dickinson à Pont de Claix dans le service de Développement pharmaceutique.

Je remercie Alain Cuiné pour m'avoir accueilli et donné l'opportunité de réaliser mon stage de fin d'étude au sein de ce service.

Je remercie l'ensemble des membres de mon jury pour leur présence, leurs conseils et l'attention qu'ils ont porté à ce travail.

Je tiens à remercier particulièrement le Dr Aziz Bakri, Professeur à l'UFR de Pharmacie de Grenoble, pour avoir accepté de présider la commission d'examen. Il a été durant toutes mes études et spécialement pendant cette dernière année, une source de conseil et une force motrice qui m'a permis de suivre mon propre chemin et de finir mon parcours étudiant dans les meilleures conditions.

Je remercie chaleureusement le Dr Nawel Khalef pour sa disponibilité. Son avis expert est d'un grand enrichissement.

Je suis fière de compter dans ce jury mon amie le Dr Cécile Roupioz. Elle m'a vu évoluer personnellement. Son regard extérieur apporte un éclairage différent à prendre en compte.

Je tiens à remercier particulièrement le Dr Didier Hoarau, responsable du service Développement Pharmaceutique de BD Medical, Pharmaceutical System, qui a guidé mes recherches tout au long de ces huit mois. Il est une grande source de connaissance scientifique. Grâce à ses conseils et à la confiance qu'il m'a porté, j'ai pu réaliser un stage riche en enseignement et surtout épanouissant.



J'ai pu compter, durant ce travail, sur Chloé Pierson, Ingénieur en pré-formulation au sein du service de Développement Pharmaceutique de BD. Grâce à son encadrement et son continuel soutien, j'ai pu mener à bien la réalisation des tests compris dans cette étude. Elle prit beaucoup de son temps pour me guider et répondre à mes nombreuses questions tout en me laissant autonome. Ce fut un réel plaisir de faire régulièrement le trajet jusqu'à son bureau pour partager ses avis tranchés et éclairés.

Je remercie également très sincèrement Pauline Romain-Rollet pour son soutien, ses conseils et son aide dans la rédaction de cette thèse. Elle est une oreille attentive forte d'expérience qu'elle a la gentillesse de me faire partager par ses conseils avisés.

J'ai eu le privilège d'être accueilli au sein d'une équipe chaleureuse composée de personnalités qui ont facilité mon travail grâce à leur aide et leur gentillesse. Ils m'ont apporté des connaissances pluridisciplinaires. C'était un plaisir de travailler avec eux.

Je remercie particulièrement les deux techniciens de formulation, Stéphane Galard et Nicolas Baumard, qui m'ont guidé dans le laboratoire de formulation et m'ont aussi assisté dans mes nombreuses conditions de test. Ils ont été assez gentil pour laisser entrer une part de féminité dans le laboratoire.

Je tiens aussi à remercier chaleureusement toute l'équipe de développement pharmaceutique de BD pour leur aide et le temps qu'ils ont bien voulu investir dans ce projet, spécialement Lucie Mollard et Carine Malessard qui ont pris une grande part dans l'aboutissement de mon stage et de cette thèse par leurs analyses et support analytique essentiel.

Ce fut un vrai plaisir de travailler dans l'atmosphère détendu qu'ils ont su créer.

---

## TABLE OF CONTENT

<b>Dédicaces</b>	<b>6</b>
<b>Remerciements</b>	<b>7</b>
<b>Table of Content</b>	<b>9</b>
<b>Liste des figures</b>	<b>11</b>
<b>Liste des tableaux</b>	<b>13</b>
<b>Glossary</b>	<b>14</b>
<b>Introduction (FRANÇAIS)</b>	<b>16</b>
<b>Développement (FRANÇAIS)</b>	<b>18</b>
<b>Introduction</b>	<b>24</b>
<b>1 Context and mission</b>	<b>26</b>
1.1 the Context	26
1.2 the Mission	30
<b>2 Bibliography</b>	<b>32</b>
2.1 General bibliography	32
2.2 stability study of X injection solution	41
<b>3 Studies at laboratory scale</b>	<b>43</b>
3.1 Introduction	43
3.2 pH and oxygen impact on X 10 mg/mL injection stability.	46
3.2.1 Material and method	46
3.2.2 Results and discussion	48
3.2.3 Conclusion	64
3.3 X injection autoclavability study and pH Discrimination	66
3.3.1 Material and method	66
3.3.2 Results and discution	67
3.3.3 Conclusion	75
3.4 X autoclavability with different stoppers and tip-cap and rubber discrimination	77
3.4.1 Material and method	77
3.4.2 Results and discussion	78
3.4.3 Conclusion	87
3.5 X pre-stability and autoclavability study at 40°C/75 % RH, 60°C and 80°C	89
3.5.1 Material and method	89
3.5.2 Results and discussion	90
<b>Conclusion</b>	<b>125</b>
<b>Bibliography</b>	<b>129</b>
<b>Appendix</b>	<b>130</b>



---

## LISTE DES FIGURES

Figure 1: BD Hypak® syringe vocabulary description	15
Figure 2: BD segment organization	27
Figure 3: R & D export from 2005 to 2009	27
Figure 4: BD revenues by geography for year 2009	28
Figure 5: BD revenues by segment for year 2009	28
Figure 6: BD Pont de Claix site	28
Figure 7: X 10 mg/mL, pH trend, 80°C	51
Figure 8: X 10 mg/mL API assay trend by UV, 80°C	51
Figure 9: X 10 mg/mL API assay trend by UPLC, 80°C	52
Figure 10: X 10 mg/mL impurities assay trend by UPLC, 80°C	53
Figure 11: X 10 mg/mL pH trend, 40°C	57
Figure 12: X 10 mg/mL API assay trend by UPLC, 40°C	58
Figure 13: X 10 mg/mL impurities assay trend by UPLC, 40°C	58
Figure 14: Impurity B UPLC assay in function of pH (80°C)	59
Figure 15: Impurity B UPLC assay in function of pH (40°C)	60
Figure 16: Impurity F UPLC assay in function of pH (80°C)	61
Figure 17: Impurity F UPLC assay function of pH (40°C)	61
Figure 18: Impurity E UPLC assay in function of pH (80°C)	62
Figure 19: Impurity E UPLC assay in function of pH (40°C)	62
Figure 20: X 2 and 10 mg/mL, pH trend	70
Figure 21: X 10 mg/mL API assay trend by UPLC	70
Figure 22: X 2 mg/mL API assay trend by UPLC	71
Figure 23: Total impurities trends for X 10 mg/mL by UPLC	72
Figure 24: Total impurities trends for X 2 mg/mL by UPLC	72
Figure 25: Impurity B UPLC assay function of autoclave cycles	73
Figure 26: Impurity F UPLC assay function of autoclave cycles	74
Figure 27: X 2 mg/mL, pH trend when autoclaved	80
Figure 28: X 2 mg/mL API assay trend by UPLC when autoclaved	81
Figure 29: X 2 mg/mL total impurities assay trend by UPLC when autoclaved	82
Figure 30: X 2 mg/mL, pH trends for 80 and 40°C storage	83
Figure 31: X 2 mg/mL API assay trend by UPLC for 80 and 40°C storage	84
Figure 32: X 2 mg/mL total impurities assay trend by UPLC at 40°C	85
Figure 33: X 2 mg/mL, inerted, autoclaved and non autoclaved pH trend at 80°C	92
Figure 34: X 2 mg/mL, inerted, autoclaved and non autoclaved PO <sub>2</sub> trend at 80°C	93
Figure 35: X 2 mg/mL, inerted, autoclaved and non autoclaved API assay trend at 80°C	93
Figure 36: X 2 mg/mL, inerted, autoclaved and non autoclaved total impurities assay trend at 80°C	94
Figure 37: X 2 mg/mL, inerted, autoclaved and non autoclaved impurity B assay trend at 80°C	95
Figure 38: X 2 mg/mL, inerted, autoclaved and non autoclaved impurity F assay trend at 80°C	96
Figure 39: X 2 mg/mL, inerted, autoclaved and non autoclaved impurity with RRT = 0.16 assay trend at 80°C	97
Figure 40: X 2 mg/mL, inerted, autoclaved and non autoclaved pH trend at 40°C	99
Figure 41: X 2 mg/mL, inerted, autoclaved and non autoclaved PO <sub>2</sub> trend at 40°C	100
Figure 42: X 2 mg/mL, inerted, autoclaved and non autoclaved API assay trend at 40°C	101

Figure 43: X 2 mg/mL, inerted, autoclaved and non autoclaved total impurities assay trend at 40°C	101
Figure 44: X 2 mg/mL, inerted, autoclaved and non autoclaved impurity B assay trend at 40°C	102
Figure 45: X 2 mg/mL, inerted, autoclaved and non autoclaved impurity F assay trend at 40°C	103
Figure 46: X 2 mg/mL, inerted, autoclaved and non autoclaved impurity with RRT = 0.16 assay trend at 40°C	104
Figure 47: X 2 mg/mL, inerted, impurity B assay in function of autoclave at 80°C	106
Figure 48: X 2 mg/mL, inerted impurity B in function of syringes oxygen partial pressure at 80°C	107
Figure 49: X 2 mg/mL, inerted impurity B assay in function of autoclave at 40°C	107
Figure 50: X 2 mg/mL, inerted impurity B assay in function of syringes oxygen partial pressure at 40°C	108
Figure 51: X 2 mg/mL, inerted impurity with RRT = 0.16 assay in function of autoclave at 80°C	109
Figure 52: X 2 mg/mL, inerted impurity with RRT = 0.16 assay in function of syringes oxygen partial pressure at 80°C	110
Figure 53: X 2 mg/mL, inerted impurity with RRT = 0.16 assay in function of autoclave at 40°C	111
Figure 54: X 2 mg/mL, inerted impurity with RRT = 0.16 assay in function of syringes oxygen partial pressure at 40°C	111
Figure 55: X 2 mg/mL, inerted, autoclaved ph trend at 60°C	114
Figure 56: X 2 mg/mL, inerted, autoclaved PO <sub>2</sub> trend at 60°C	114
Figure 57: X 2 mg/mL, inerted, autoclaved API assay trend at 60°C	115
Figure 58: X 2 mg/mL, inerted, autoclaved total impurities assay at 60°C	116
Figure 59: X 2 mg/mL, inerted, autoclaved impurity B assay trend at 60°C	117
Figure 60: X 2 mg/mL, inerted, autoclaved impurity F assay trend at 60°C	118
Figure 61: X 2 mg/mL, inerted, autoclaved impurity with RRT = 0.16 assay at 60°C	119
Figure 62: ln(D <sub>0-i</sub> ) in function of time for 40°C, 60°C and 80°C	120
Figure 63: lnk function of 1/T for 40°C, 60°C and 80°C.	122
Figure 64: Plot of concentration of A versus time for a first-order reaction	130
Figure 65: Plot of the natural logarithm of the concentration of A versus time for a first-order reaction	131
Figure 66: Variation of the rate constant with reciprocal absolute temperature, illustrating the Arrhenius equation	133

---

## LISTE DES TABLEAUX

<i>Table I: Stress degradation conditions for validation of analytical stability indicating assay</i>	34
<i>Table II: Comparison between analytical and pre-formulation stress degradation studies</i>	35
<i>Table III: Unit and batch formulas for X 10 mg/mL and 2 mg/mL</i>	44
<i>Table IV: Tests performed and acceptance criteria</i>	44
<i>Table V: 80°C and 40°C/75 % RH samples and conditions of storage</i>	47
<i>Table VI: Forced degradations results for formulation under air at 80°C</i>	49
<i>Table VII: Forced degradations results for formulation under nitrogen at 80°C</i>	50
<i>Table VIII: Forced degradation results for formulation under air at 40°C/75 % RH</i>	55
<i>Table IX: Forced degradation results for formulation under nitrogen at 40°C/75 % RH</i>	56
<i>Table X: Autoclavability and pH determination study samples and conditions of stress</i>	67
<i>Table XI: Forced degradations results for X 2 mg/mL</i>	68
<i>Table XII: Forced degradations results for X 10 mg/mL</i>	69
<i>Table XIII: Rubber compatibility studies samples</i>	77
<i>Table XIV: Rubber compatibility study conditions of storage</i>	78
<i>Table XV: Rubber compatibility forced degradation results for X 2 mg/mL injection</i>	79
<i>Table XVI: Pre-stability and autoclavability samples at 40°C/75 % RH, 80°C, 60°C conditions</i>	90
<i>Table XVII: X 2 mg/mL, inerted, autoclaved and non autoclaved injection stability results at 80°C</i>	91
<i>Table XVIII: X 2 mg/mL, inerted, autoclaved and non autoclaved injection stability results at 40°C</i>	98
<i>Table XIX: X 2 mg/mL stability results at 60°C after autoclave</i>	113

---

## GLOSSARY

<b>ABL 5</b>	Instrument used to measure the oxygen partial pressure in mmHg thanks to an amperometric electrode
<b>API</b>	<b>Active Pharmaceutical Ingredient</b>
<b>atmosbag</b>	Plastic bag where we can add nitrogen pipe entries. The inside environment can be separate from the outside in order to create an atmosphere free from oxygen
<b>Autoclave</b>	A strong pressurized, steam heated vessel used to perform sterilization, chemical reactions
<b>Barrel</b>	See figure 1 below
<b>BD</b>	<b>Becton Dickinson</b>
<b>BDM-PS</b>	<b>BD Medical Pharmaceutical System</b>
<b>Hypak®</b>	Model of glass syringe developed by BD and manufactured in Pont de Claix site
<b>ICH</b>	<b>International Conference on Harmonisation</b>
<b>Isotonic agent</b>	substances that help the solution to have an osmotic pressure the same as blood
<b>NMT</b>	<b>Not More Than</b>
<b>pH adjuster</b>	acid or soda are often use to regulate pH in chemical process streams
<b>PPH</b>	<b>Pont de Claix Pharmaceutical Home Center</b>
<b>pre-stability</b>	Study during development phase to test stability of formulations. It can be similar to regulatory accelerated stability studies but with a different purpose. The purpose of pre-stability study is mainly to set an optimized formulation while the stability study is mainly used to confirm this formulation and to determine the appropriate shelf life.
<b>PP</b>	<b>Polypropylen</b> (injections bags are done with this material)
<b>R&amp;D</b>	<b>Research and Development</b>
<b>Revenues</b>	Incomes that a company receives from its normal business activities (sale of goods and services to customers)
<b>RH</b>	<b>Relative Humidity</b>

<b>RLD</b>	<b>Reference Listed Drug</b>	
<b>Rondo</b>	Plastic medium in which the syringes can be stored. A rondo can handle 18 syringes positioned horizontally	
<b>RRT</b>	<b>Relative Retention Time:</b> time with which components exit from the UPLC column	
<b>RT</b>	<b>Room Temperature</b>	
<b>rubber</b>	See figure 1 below	
<b>SCF</b>	<b>Sterile Clean and Ready to Fill</b>	
<b>Solvent</b>	liquid, solid, or gas that dissolve another solid, liquid, or gaseous solute, resulting in a solution	
<b>SPU</b>	<b>Stopper Placement Unit.</b> Laboratory apparatus used to cork syringes with stoppers. The stoppering can be performed with air, or with nitrogen	
<b>stopper</b>	See figure 1 below	
<b>Suntest</b>	Material that provides a light source (ex: artificial daylight fluorescent lamp combined with visible ultraviolet), used to determine if APIs degrade when exposed to light.	
<b>Tip cap</b>	See figure 1 below	
<b>UPLC</b>	<b>Ultra Performance Liquid Chromatography</b> used to perform assays on solutions	
<b>USP</b>	<b>United States Pharmacopeia</b>	
<b>UV</b>	<b>Ultra Violet:</b> laboratory apparatus used to perform API assays by wavelength detection	
<b>WFI</b>	<b>Water For Injection</b> used here as solvent in injection solution	

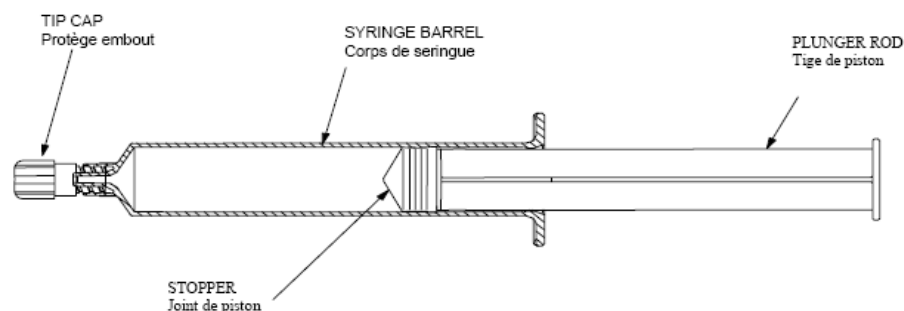

Figure 1: BD Hypak® syringe vocabulary description



---

## INTRODUCTION (FRANÇAIS)

Ce travail porte sur l'implémentation et l'optimisation d'études de dégradation forcée en pré-développement pour l'amélioration du screening des formulations. Il a été réalisé durant une étude de huit mois au sein de l'entreprise Américaine Becton Dickinson (BD), à Pont de Claix, en France.

BD est une entreprise de technologie médicale qui développe, fabrique et vend des dispositifs médicaux, des instruments de laboratoire, des anticorps, des réactifs et des produits de diagnostique.

Le site de Pont de Claix est spécialisé dans le développement et la production de seringues en verre pour les industries pharmaceutiques et les professionnels de santé.

Le marché des seringues pré-remplies est en pleine expansion. Pour certains collaborateurs de l'entreprise, évaluer la stabilité et la compatibilité des formulations avec les dispositifs médicaux de Becton Dickinson représente un réel avantage pour leur développement.

La première étape importante dans la fabrication de solutions injectables, est d'étudier les caractéristiques de stabilité des solutions et des principes actifs utilisés.

L'objectif de ce stage était d'implémenter une méthode sûre, rapide et facile à appliquer pour réunir des données concrètes sur la sensibilité des principes actifs et la stabilité des formulations face à différentes conditions drastiques de pH, chaleur, lumière ou oxygène par exemple.

Ces expériences que l'on appellera tests de dégradation forcée en pré-développement pourront faciliter et accélérer le processus de développement pharmaceutique.

Tout d'abord, le contexte et une description plus précise de l'étude et de ses objectifs seront exposés.

Ensuite, la partie bibliographie synthétisera l'existant sur le sujet et regroupera les informations de stabilité trouvées sur le principe actif, nommé X, choisi pour subir les tests au cours de son développement. Ces recherches ont amené à l'établissement d'un protocole global qui décrit la méthodologie de réalisation des tests de dégradation forcée.

En troisième partie, quatre études menées dans le laboratoire de formulation seront détaillées. Elles ont permis de déterminer la sensibilité du principe actif X et d'établir la stabilité de la formulation face à la variation de différents paramètres. Leur objectif était aussi de permettre la validation de la méthode employée pour les tests de dégradation forcée en pré-développement et de réaliser une extrapolation des résultats obtenus afin d'avoir une idée plus précise sur le comportement de la formulation étudiée à 25°C.

Les perspectives et la conclusion de cette étude seront enfin exposées.

---

# DEVELOPPEMENT

## 1. CONTEXTE ET MISSION

Les études présentées dans cette thèse ont été réalisées au sein du service de recherche et développement de la société BD à Pont de Claix. Ces études avaient pour objectif l'implémentation d'une technique fiable, rapide et facile à développer pour déterminer les facteurs principaux influençant la sensibilité de principes actifs et la stabilité de formulations injectables devant être conditionnées en seringue de type Hypack® SCF fabriquées sur le site.

L'étude des cinétiques de dégradation est une recherche importante durant le développement d'un nouveau produit pharmaceutique. En effet, l'instabilité d'une formulation peut amener à une perte d'activité de l'actif et à la formation de nouvelles espèces chimiques potentiellement toxiques. Cette étape doit donc être prise en compte par les entreprises de technologie médicales considérant que cela peut rallonger le temps et augmenter le cout de développement, en plus de raccourcir la date de péremption des produits.

Le but est donc d'établir, en pré-formulation, des tests permettant d'évaluer la stabilité des formulations face à différentes conditions drastiques de pH, lumière, oxydation, chaleur, conditionnement par exemple.

L'équipe de développement pourra alors avoir plus d'informations sur la sensibilité des principes actifs. Les résultats collectés aideront à fixer les paramètres finaux de la formulation.

Finalement, ces tests permettront l'optimisation du processus global de développement des médicaments.

La deuxième partie de cette thèse concerne la recherche bibliographique mise en œuvre pour répondre à différentes problématiques liées à la dégradation d'un principe actif:

- Quelles conditions peuvent influencer la sensibilité des molécules,
- Quels paramètres de la formulation peuvent être testés facilement en laboratoire,
- Existe-t-il déjà des tests mis en place par d'autres structures,
- La recherche des paramètres de stabilité particuliers pouvant influencer les actifs devant être développés par l'équipe.

## 2. BIBLIOGRAPHIE

Le chapitre bibliographie de cette thèse développe trois points concernant la problématique des tests de stabilité.

Il est d'une part possible de déterminer le mode de dégradation d'une nouvelle molécule dont l'étude n'a pas encore été faite. En effet, d'après SINGH S. et BAKSHI M, l'évaluation de la sensibilité des molécules passe par l'étude de leur structure. Un classement des produits peut ensuite être envisagé et l'emploi d'un arbre décisionnel aidera à l'établissement des conditions adéquates de test.

Ensuite nous verrons que certaines structures, dont Becton Dickinson, ont établi des tests de dégradation forcées pour la validation de leurs méthodes analytiques. Les conditions de stress rappellent la méthode développée par SINGH S. et BAKSHI M. Ces tests, pré-requis dans le dossier de développement, visent à dégrader fortement la molécule afin d'être en mesure de séparer toutes les impuretés et de les classer en impuretés de dégradation ou de synthèse. Ce point, bien qu'intéressant, ne répond pas totalement aux recherches menées dans cette thèse. La dernière méthode présentée dans la bibliographie générale permettra de se rapprocher du but des études à développer.

La prédiction de la sensibilité des principes actifs et de la stabilité des formulations peut en effet être établie par plusieurs méthodes utilisant les lois de cinétique universelles. Deux de ces modèles seront développés ici : les méthodes isothermales et non-isothermales. La méthode isothermale sera choisie pour pratiquer les tests au laboratoire.

Finalement, un protocole sera rédigé afin d'aider à l'application des études de dégradation forcée en pré-formulation. Il décrit précisément les conditions drastiques appliquées pour tester différents paramètres d'une formulation et déterminer les conditions optimales de stabilité.

### **3. ETUDES A L'ECHELLE DU LABORATOIRE**

Durant cette étude de huit mois, de nombreux essais ont été réalisés au laboratoire de formulation, ceci dans plusieurs buts.

D'une part les premiers tests ont permis de mieux comprendre les phénomènes de dégradation qui peuvent se produire sur un principe actif en formulation comparément aux données théoriques. Ces observations ont permis d'affiner les paramètres de tests décrits dans le protocole afin d'avoir des réactions de dégradation rapides mais aussi et surtout représentatives d'une dégradation en condition ambiante.

Ensuite, les tests de dégradation forcée ont été appliqués à une molécule spécifique choisie, nommée X, afin de déterminer les paramètres optimaux de stabilité de la formulation.

Quatre expériences appliquées à la molécule X sont détaillées dans cette thèse.

La première expérience a permis d'étudier l'effet du pH et de l'oxygène sur la molécule.

Plusieurs formulations ont été mises en stabilité à 40°C/75 % RH et 80°C regroupant quatre pH différents (2.5, 4.0, 5.0 et 6.5) et deux types de procédé pour chaque pH (inertage à l'azote ou non). Chacune ont été contrôlées, à différents temps de conservation, sur leur pH, leur taux d'oxygène, leur dosage en principe actif et en impuretés.

Les résultats ont montré une forte augmentation du taux d'impuretés et une importante chute de pH pour les formulations non inertées. Concernant l'effet du pH, les formulations ajustées aux pH extrêmes de l'étude, 2.5 et 6.5, ont montré le plus haut taux

d'impuretés et la plus importante instabilité en pH. Les deux autres formulations ajustées à pH 4.0 et 5.0, montrant des résultats équivalents, ont été discriminées lors d'études de dégradation forcées subséquentes. D'après les résultats de cette première expérience, il est donc important de protéger la molécule de l'oxygène, l'oxydation ayant été identifiée comme le mode de dégradation majeur de la molécule X. L'inertage est donc une bonne solution, l'azote, gaz inerte, prend la place de l'oxygène dans la solution lors de la formulation et du stockage et empêche une trop forte oxydation.

La deuxième expérience décrite a permis de préciser le pH optimum de stabilité de la formulation et de faire une première évaluation sur l'effet de l'autoclavage. Deux formulations de concentrations différentes, 2 mg/mL et 10 mg/mL, ont été soumises à un ou deux cycles d'autoclave.

Les formulations étaient inertées et ajustées à pH 4.0 et 5.0.

Les résultats ont montré que chaque formulation peut subir l'autoclavage, dans le type de conditionnement utilisé pour cette étude. Il s'agissait de flacons en verre ambré hermétiques car scellés par une capsule en aluminium. Les seringues Hypack® SCF n'étant pas totalement comparables à ces flacons, une étude complémentaire sera réalisée pour déterminer le comportement réel de la formulation lorsque conditionnée dans ce contenant final.

Concernant la détermination du pH optimum, cette étude ne montre pas de discrimination particulière. Le pH 5.0 a été choisi. En effet, il est notamment plus proche du pH physiologique mais aussi du pH obtenu lors de la mise en solution de X.

La troisième expérience présentée permet de déterminer l'impact des composants de la seringue sur la formulation tout en évaluant l'effet de l'autoclave dans ces nouvelles conditions. Trois composants influençant potentiellement la stabilité de la solution sont testés : le Stopper A, le Stopper B et le Tip-cap A (deux joints de piston et un bouchon). Ils sont mis en contact, en excès, avec la formulation et placés en condition de stress à 80°C pendant un maximum de 14 jours et à 40°C/75 % RH pendant 1 mois. Le test est effectué en flacon scellé.

Les résultats montrent une importante augmentation des impuretés et une chute du dosage en principe actif pour les échantillons mis en contact avec le Tip-cap A. Le pH lui aussi montre une importante chute. Les impuretés créées ne sont pas dues à l'oxydation mais sûrement au contact entre l'élastomère et la solution. Etant donné que le tip-cap était en excès, on peut s'attendre à un résultat moins franc lorsque les formulations seront conditionnées en seringues (très faible surface de contact) mais ce phénomène sera à surveiller lors de la pré-stabilité de X en seringue.

Concernant le choix du stopper, aucune différenciation n'est faite sur cette étude. Les deux stoppers montrent les mêmes petites augmentations en impureté et une faible chute en pH. Sachant d'expérience que le Stopper B a de meilleurs comportements face à l'autoclavage, il est choisi pour continuer les investigations.

Enfin la dernière expérience réalisée en seringue Hypack® SCF à 40°C/75 % RH, 60°C et 80°C avait un but double.

Tout d'abord, elle a été mise en place pour statuer sur le processus d'autoclavage, pour la formulation de X dans son conditionnement final. Les résultats ont aussi permis d'établir une corrélation afin de déterminer la reproductibilité de la méthode employée. Une extrapolation à 25°C a été réalisée utilisant les règles de cinétique globales. Ces calculs orientent vers le constat que les études à 40°C/75 % RH, 60°C et 80°C sont reproductibles. Les données réunies ont toutes les mêmes tendances. De plus, les données expérimentales sont proches des données théoriques et montrent que les études à haute température ont une dégradation du même ordre qu'à 25°C. L'extrapolation a permis de déterminer une énergie d'activation environ égale à  $41 \text{ kJ.mol}^{-1}$  dirigeant vers l'hypothèse que l'oxydation, décrite comme le mode de dégradation majeur de X, prend une part importante dans les réactions étudiées mais que ce ne serait pas le seul phénomène compris dans la dégradation de X. Une instabilité à la chaleur et à la lumière pourrait en être aussi responsable.

Une étude de pré-stabilité est en cours ainsi que des études de stabilité sur des lots de formulation fabriqués en zone pilote. Les données qui seront collectées durant ces études devront être comparées aux résultats obtenus lors des dégradations forcées en pré-développement.



---

## INTRODUCTION

The establishment and implementation of the study described in this thesis were conducted during an eight-month internship performed within the US Company Becton Dickinson (BD), at Pont de Claix site, in France.

BD is a leading global medical technology company that develops, manufactures and sells medical devices, laboratory instruments, antibodies, reagents and diagnostic products.

The site of Pont de Claix is specialized in the development and production of glass syringes, designed for the pharmaceutical industries and for health care professionals.

The market of pre-filled syringes is growing. It represents a real opportunity to help BD customers assessing the stability or compatibility of their formulations with BD devices.

The first step in an injectable development is to consider the active pharmaceutical ingredient stability characteristics. The time required for the studies can be very lengthy because chemical reactions proceed relatively slow at ambient temperature. The experiments described here dealt with the implementation of the better, faster and more convenient way to assess the sensitivity of API and the stability of formulations when exposed to several stress conditions (pH variation, heat, light exposure, oxidation, etc) in order to facilitate and accelerate the formulation process, among other things.

First, the extent of this thesis will be introduced with a more specific description of the study and its objectives in the context of BD Company.

The bibliography will then be exposed. This research led to the establishment of a global work instruction meant to guide the experiments performed.

The specific bibliography performed on the first API chosen to be tested, named X, will also be developed.

In the third part, four studies carried out in the formulation laboratory will be detailed. The goal was to understand the behavior of the active ingredient X when put in stress conditions. It permitted to determine the formulation optimum stability. The objective was also to validate the pre-development forced degradations method by results correlation. Stability data at 25°C were obtained by extrapolation.

Perspectives and conclusion of this study will finally be exposed.

# 1 CONTEXT AND MISSION

## 1.1 THE CONTEXT

Becton Dickinson is a leading global American medical technology company focused on improving API delivery, enhancing the quality and speed of diagnosing diseases and cancers, advancing research, discovery and production of new dosage forms and vaccines.

The company develops, manufactures and sells medical devices, laboratory instruments, antibodies, reagents and diagnostic products in order to serve healthcare institutions, life science researchers, clinical laboratories, the pharmaceutical industry and the general public with diversify customers such as:

- Hospitals and clinics,
- Physicians' office practices,
- Consumers and retail pharmacies,
- Governmental and nonprofit public health agencies,
- Pharmaceutical companies,
- Healthcare workers.

BD, headquartered in Franklin Lakes in the United States, employs approximately 29,000 associates in 50 countries throughout the world and is divided into three worldwide segments and eight Units, seen Figure 2:

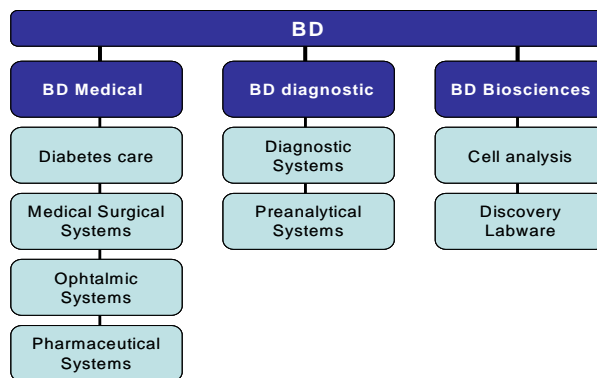

Figure 2: BD segment organization

Nowadays BD is turning its activities towards innovative fields like the development of devices which will respond to new molecules and patient needs (Accuspray™: nasal spray for flu vaccine, or innovative devices safer to use for example).

In that purpose, during the first years of 21<sup>st</sup> century, BD branched out by the purchase of various companies that brought new technologies (GeneOhm, HandyLab, Inc.). It helped BD staying one of the most gainful companies in the pharmaceutical device world and permitted the start of new projects based on Research and Development.

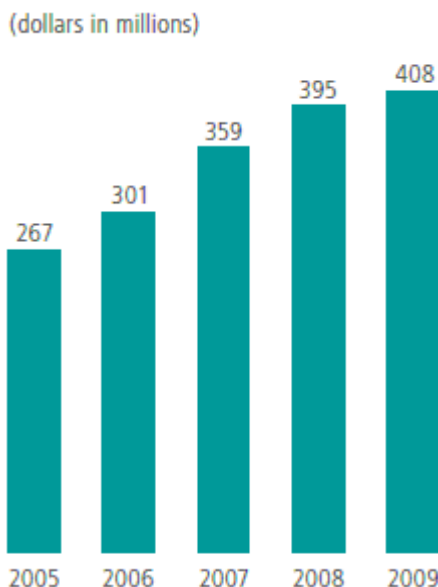

Figure 3: R & D export from 2005 to 2009

As it can be seen in Figure 3, these last years, BD increased its R & D expenses. Despite the economic worldwide crisis Becton Dickinson stays a competitive company by its investment in innovative research.

Globally and as shows Figure 4 which details results for year 2009, the company exports more than 50 % of its sales out of the United States, mainly in Europe.

Moreover, BD Medical’s revenues are higher than other sections. It represents more than 50 % of BD total revenues comparatively to BD Bioscience and BD Diagnosis altogether (see Figure 5).

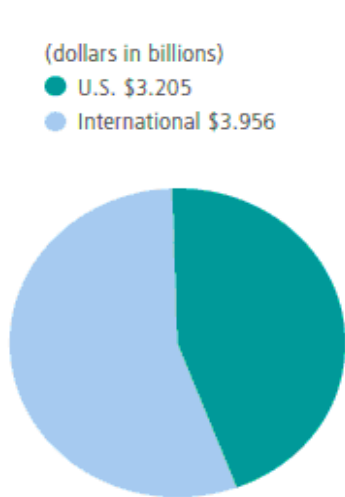

Figure 4: BD revenues by geography for year 2009

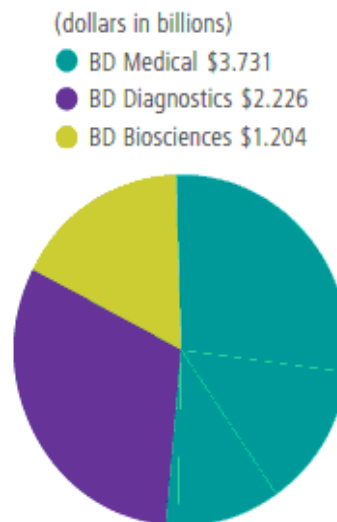

Figure 5: BD revenues by segment for year 2009

Most of BD’s 1,753 associates in France are located in Pont-de-Claix site near Grenoble. This site is the worldwide head office of BD Medical – Pharmaceutical Systems (BDM-PS) and the only business unit having it’s headquarter outside the U.S. It offers General Management, Customer-Facing Team, Sales, Research & Development, Marketing, Medical Affairs, Quality, Regulatory Affairs, Technical Support and Industrial Operations.



Figure 6: BD Pont de Claix site

The study exposed in this thesis was performed in a small entity of BD Pont de Claix site called PPH for “Pont de Claix Pharmaceutical Home Center”. PPH is dedicated to provide quality control and other services to internal or external customers. It contains different laboratories (formulation, microbiology, chemistry).

## 1.2 THE MISSION

The research exposed in this thesis mainly hinged on implementing the most predictive and rapid way to determine, by anticipation time, formulation factors influencing sensitivity of APIs. The method will help produce stable injectable solutions in prefilled syringes: BD Hypak® SCF.

The study of drug degradation kinetics and the pursuit of the most stable formulation are important research activities during the development of new pharmaceutical products. Instability can lead, especially for sensitive APIs, to chemical degradation, loss of drug potency and the possible formation of new chemical species with potential toxic sides effects. This issue has to be taken into account as it can reduce significantly the product shelf life and can also affect development time and cost.

Consequently, risks that can be incur during the development of new drug products are:

- The lack of time, due to fast development, to collect concrete data about active ingredients sensitivity and formulation stability regarding several parameters: variations of pH, oxygen level, light exposition, syringe's component for example.
- Numerous pre-stability conditions. Pre-stability studies could be a way to collect formulation stability data. The studies are performed when the formulation is almost set, and workable results will keep people waiting for the final formulation selection as the studies would last about two to three months,
- If one pre-stability condition set shows problems of stability after storage, it can lead to backward steps if the determined formulation includes one of the parameters that influence negatively the stability,
- Loss of time and raw material if pre-stability and other studies have to be reset.

Therefore the goal of this study was to set tests, in pre-formulation, which will allow determining formulation stability regarding different stress conditions of pH, light, oxidation, heat, packaging and so on.

Then the development team will have better information about the active pharmaceutical ingredient sensitivity. Results collected will help set the final formulation parameters and pre-stability study conditions. It will lead to a global optimization of the development process of the dosage form.

The studies have to be done in a short time, to provide quickly workable results and avoid development slow down. Higher temperature than pre-stability studies will be chosen to accelerate the degradation kinetic. Reactions generated have also to be representative of a degradation at room temperature (25°C).

The mission included a large part of bibliographic researches to get familiar with global degradation data:

- Which conditions can influence the active ingredient sensitivity?
- What parameters can easily be tested?
- What are the existing tests to determine the formulation stability?
- Specific stability data research about a drug chosen to be developed by the team.

The bibliography led to the redaction of a work instruction that describes conditions to test different formulations parameters. This draft protocol is to be applied at the early development stage of the dosage form. It will help in the application of pre-formulation stress degradations.

By the application of this protocol, various tests were performed at laboratory scale. First tests were helpful to affine stress conditions so as to get formulation degradation still representative of a 25°C degradation. The final tests conditions were then applied to a specific active ingredient. It was the first to undergo stress degradation studies for the determination of its formulation parameters.

Part of this active pharmaceutical ingredient forced degradation study will be detailed later on.



## 2 BIBLIOGRAPHY

### 2.1 GENERAL BIBLIOGRAPHY

The purpose of this study naturally leads to find examples of stability tests occurring during the first steps of development.

The International Conference on Harmonization (ICH) guideline entitled “stability testing of New Drug Substances and Products” (Q1A) requires that stress testing should be carried out to elucidate the inherent stability characteristics of the product. Studies performed should include the effect of temperature, oxidation, and photolysis susceptibility across a wide range of pH values. Such studies should also involve “stress” conditions more severe than accelerated testing (>40°C and >75 % Relative Humidity).

A specific guideline for photolysis (Q1B), describes which light parameter is to be set to test molecules. The user has to employ a light source designed to produce an output similar to the D65/ID65 emission standard. This light has to provide an overall illumination of not less than 1.2 million lux hours and an integrated near ultraviolet energy of not less than 200 watt hours/square meter in order to validate an energy similar to day light exposition.

Stress testing is considered as an early evaluation of new drugs. It can be done on either drug product or drug substance and can be used to collect several important data such as the three elements exposed below:

### 1. Finding new molecule degradation pathways

S. SINGH and M. BAKSHI present a classification system and a decision tree to guide on how to start and where to end the search of the right type of stress conditions to degrade a new drug.

The classification system goes by a complete bibliography. A list of every test conditions used in the pharmaceutical world is done first. Secondly, drugs are classified from practically stable to extremely labile based on the molecule functional groups and its overall structure. Flow charts are then drawn to decide on stress conditions to apply (hydrolysis: under neutral, acid and alkaline conditions, oxidation and photolysis).

Depending on the drug sensitivity, the authors give a decision tree that helps deciding which stress conditions can be applied first to start a test.

### 2. Development and validation of analytical methods to separate impurities and identify degradation products

In the literature, multiple publications deal with analytical forced degradation studies illustrating what is done in other industries. Conditions used catch up with S. SINGH and M. BAKSHI publication.

Data collected from this research are summarized in Table I. An internal research about BD practices regarding the use of forced degradations in an analytical purpose is included.

Table I: Stress degradation conditions for validation of analytical stability indicating assay

Method							
<b>Oxidation studies</b>	<ul style="list-style-type: none"> <li>- H<sub>2</sub>O<sub>2</sub> at 3 % during 3 minutes at reflux</li> <li>- H<sub>2</sub>O<sub>2</sub> at 30 % during 5 hours at 70°C</li> <li>- H<sub>2</sub>O<sub>2</sub> at 3 % during 24 hours at RT and H<sub>2</sub>O<sub>2</sub> at 30 % during 48 hours at RT</li> <li>- H<sub>2</sub>O<sub>2</sub> at 3 % during 24 hours at RT</li> <li>- BD method: H<sub>2</sub>O<sub>2</sub> at 3 % during 10 hours at RT</li> </ul>						
<b>Heat studies</b>	<ul style="list-style-type: none"> <li>- 60°C during 3 days</li> <li>- 105°C during 30 days</li> <li>- 50°C during 60 days and 60°C during 15 days</li> <li>- 50°C during 45 days and 60°C during 7 days</li> <li>- BD method: 80°C during 24 hours</li> </ul>						
<b>Light studies</b>	<ul style="list-style-type: none"> <li>- 210 Watt hours/m<sup>2</sup> (between 320 – 400nm) during 40 hours</li> <li>- Sunlight during 8 hours</li> <li>- Photostability chamber during 60 days</li> <li>- Sunlight (between 60,000 – 70,000 Lux)</li> <li>- BD method: 200 Wh/m<sup>2</sup> between 320 - 400 nm, 1.2 million lux hours, between 400 - 800 nm</li> </ul>						
<b>Hydrolysis</b>	<table border="1"> <tr> <td><b>Acidic</b></td> <td> <ul style="list-style-type: none"> <li>- 2 M HCl during 30 minutes at reflux</li> <li>- 37 % HCl during 5 hours at 70°C</li> <li>- 0.1 N and 1 N HCl during 8 days at 80°C</li> <li>- 0.1 M and 1 M HCl during 8 hours at 80°C</li> <li>- BD method: 10 % of HCL 1 N during 24 hours</li> </ul> </td> </tr> <tr> <td><b>Basic</b></td> <td> <ul style="list-style-type: none"> <li>- 2 M NaOH during 30 minutes at reflux</li> <li>- 50 % NaOH during 20 hours at 70°C</li> <li>- 0.1 N and 1 N NaOH during 8 days at 80°C</li> <li>- 0.1 M NaOH during 8 hours at 80°C and 1 M NaOH during 8 hours at 40°C</li> <li>- BD method: 10 % of NaOH during 2 hours</li> </ul> </td> </tr> <tr> <td><b>Neutral</b></td> <td> <ul style="list-style-type: none"> <li>- In water during 3 hours</li> <li>- In water during 5 hours at 70°C</li> <li>- In water during different periods of time at 80°C</li> <li>- In water during 8 hours at 80°C</li> <li>- BD method: in water during 24 hours.</li> </ul> </td> </tr> </table>	<b>Acidic</b>	<ul style="list-style-type: none"> <li>- 2 M HCl during 30 minutes at reflux</li> <li>- 37 % HCl during 5 hours at 70°C</li> <li>- 0.1 N and 1 N HCl during 8 days at 80°C</li> <li>- 0.1 M and 1 M HCl during 8 hours at 80°C</li> <li>- BD method: 10 % of HCL 1 N during 24 hours</li> </ul>	<b>Basic</b>	<ul style="list-style-type: none"> <li>- 2 M NaOH during 30 minutes at reflux</li> <li>- 50 % NaOH during 20 hours at 70°C</li> <li>- 0.1 N and 1 N NaOH during 8 days at 80°C</li> <li>- 0.1 M NaOH during 8 hours at 80°C and 1 M NaOH during 8 hours at 40°C</li> <li>- BD method: 10 % of NaOH during 2 hours</li> </ul>	<b>Neutral</b>	<ul style="list-style-type: none"> <li>- In water during 3 hours</li> <li>- In water during 5 hours at 70°C</li> <li>- In water during different periods of time at 80°C</li> <li>- In water during 8 hours at 80°C</li> <li>- BD method: in water during 24 hours.</li> </ul>
	<b>Acidic</b>	<ul style="list-style-type: none"> <li>- 2 M HCl during 30 minutes at reflux</li> <li>- 37 % HCl during 5 hours at 70°C</li> <li>- 0.1 N and 1 N HCl during 8 days at 80°C</li> <li>- 0.1 M and 1 M HCl during 8 hours at 80°C</li> <li>- BD method: 10 % of HCL 1 N during 24 hours</li> </ul>					
	<b>Basic</b>	<ul style="list-style-type: none"> <li>- 2 M NaOH during 30 minutes at reflux</li> <li>- 50 % NaOH during 20 hours at 70°C</li> <li>- 0.1 N and 1 N NaOH during 8 days at 80°C</li> <li>- 0.1 M NaOH during 8 hours at 80°C and 1 M NaOH during 8 hours at 40°C</li> <li>- BD method: 10 % of NaOH during 2 hours</li> </ul>					
<b>Neutral</b>	<ul style="list-style-type: none"> <li>- In water during 3 hours</li> <li>- In water during 5 hours at 70°C</li> <li>- In water during different periods of time at 80°C</li> <li>- In water during 8 hours at 80°C</li> <li>- BD method: in water during 24 hours.</li> </ul>						

RT: Room Temperature (cf: glossary)

Between each molecule, parameters employed show variations. Duration of experiments depends on the active pharmaceutical ingredient and on the formulation involved. Of course, drugs behavior facing stress interrelates with their chemical structure.

For example, structures with oxygen (phenol...) or nitrogen (tertiary amine...) functions may be particularly sensitive to oxidation while others may not be degraded after considerable exposure.

The first and second points previously described give a good idea of what can be done to degrade a molecule. Analytical stress methods will help develop a chromatographic method to separate the API from its related substances (degradation products and impurities). The study described hereafter wants to determine if specific parameters could affect active ingredients sensitivity, an extreme degradation is not necessary. Differences between analytical stress degradation studies and pre-formulation degradation studies are highlighted in Table II.

Table II: Comparison between analytical and pre-formulation stress degradation studies

Analytical stress degradations	Pre-formulation stress degradations
Prerequisite. Is part of development files (ICH guideline)	Not prerequisite
Hard conditions are employed for quantitative degradation	Less aggressive conditions are employed for more qualitative degradation
Specific analytical purpose: <ul style="list-style-type: none"> <li>Identify every impurity that can be assayed,</li> <li>Classify them into degradation impurity or synthesis impurity,</li> <li>Validate the method specificity (separation of related substances from API),</li> <li>Validate the impurities assay method</li> </ul>	The purpose is to improve the knowledge of API sensitivity and formulations stability
Performed at the end of analytical method development, in the middle of development	Has to be performed in pre-formulation, upstream from the development process
	Help analyst evaluate the method's performance before validation

Of course, both tests have their own goal but they can also be complementary. As pre-development forced degradation studies will be performed upstream from every other

tests, it will help in the identification of impurities and in the degradation pathways of the API. As seen before, analytical stress degradation method is already applied during analytical method development of active ingredient; it will be useful to use this knowledge in the implementation of pre-formulation degradation stress.

The following third point shows that forced degradation studies, related to this study goal, have already been used to facilitate and accelerate pharmaceutical development of drug products.

3. Predict the sensitivity of drug substance and determine, between several formulations, the most stable

The amount of stress is important in this case and not the extent of degradation. Stress-testing conditions have to give a realistic vision, representative of what can happen during the drug product "life".

Indeed, thoughts developed among others by Arrhenius and based on global kinetic laws, over stressing molecules can lead to degradation profiles not representative of real storage conditions and not relevant for the development.

Accelerated aging involves increasing temperature to accelerate reactions. However, conditions over 80°C are rarely used. Over raising the storage temperature may change the rate determining reaction that is observed when formulations are stored in ambient conditions. If the reaction rate changes, stress degradation results will no more help extrapolating stability at 25°C.

Regarding general data given by K. C. WATERMAN and R. C. ADAMI, after storage and degradation, the process of estimating ambient stability involves calculating the reaction rate at different temperatures, and then extrapolating to the desired temperature.

The two most popular approaches to allow this are:

Isothermal method

The first thing is determining the reaction rate of the active ingredient degradation.

Degradation reactions are only studied at their beginning in pharmaceutical models, the worst case being when the solution has lost 5 % of its API content. Rate reactions are then approximated to be order 1; reactants exponentially decay to products. If the degradation follows another reaction rate, the section of interest for pharmaceuticals kinetics can always be approximated to be linear. If the reaction rate changes, it will be later in time. This part of the degradation is not included in pharmaceuticals studies (see Appendix 1). With this order 1 approximation, it is then possible to use Arrhenius' law.

The rate equation is shown below for first order reactions based on formation of product, here impurities ("D0" is the initial dosage form concentration, "i" the impurity content at time "t" and "P0" represents the initial product concentration which is assumed to be zero here):

$$\left[1 - \frac{i}{D0}\right]_t = [P0]e^{-kt}$$

Equation 1: First order equation

Following kinetic laws, described in Appendix 1, Equation 1 can be linearized to give Equation 2. The rate depends linearly on product concentration. This relation will be used later on.

$$\ln\left(1 - \frac{i}{D0}\right) = -kt$$

Equation 2: First order equation linearized

Traditionally, accelerated pharmaceutical stability studies are carried out at a set of fixed temperatures. The data provided by this isothermal method can then be used in the Arrhenius equation (See Equation 3) to predict ambient stability.

Reaction rate will follow Arrhenius kinetic for the majority of products. Arrhenius kinetic is a linear dependence of the natural logarithm of the reaction rate "k", versus the reciprocal of the absolute temperature "T" as shown below. "Ea" is the activation energy, "A" the pre-exponential factor and "R" the gas constant.

$$k = A \cdot e^{-E_a/RT}$$

Equation 3: Arrhenius equation

Following general kinetics laws and the notion of  $Q_{10}$ , D.W. REYNOLDS and al. use the study realized by K.A. CONNERS and al.

$Q_{10}$  is the coefficient with which the reaction rate (k) will be multiplied if the temperature of the reaction is increased by 10°C (see Appendix 1).

Assuming that an activation energy affords nearly a doubling of the reaction rate for every 10 °C increase and that this is a conservative estimate, one can calculate the amount of time a sample should be stored at a specified temperature to achieve the energy equivalent of exposure at accelerate stability conditions. It will then be possible to extrapolate results obtained with stress degradations studies and find the formulation stability at ambient temperature.

Thus, for example, a compound that degrades with  $E_a = 50 \text{ kJ}\cdot\text{mol}^{-1}$ : storage at 80°C for 12 days is kinetically equivalent to storage at 40°C for 6 months and also equivalent to storage at 25°C for 2 years (ICH condition).

### Non-isothermal method

There can be considerable errors associated with the temperature extrapolation because the number of temperatures generally used in pharmaceutical investigations is small. To counter this, long aging time are often employed, especially at temperatures close to ambient. Unfortunately, the time involved in such predictions can be considerable.

Non-isothermal method is suggested to narrow the confidence intervals in the same aging time.

It was developed to reduce experimental effort. This technique allows estimation of kinetic parameters from a single set of dosage form formulation versus time data obtained while the temperature is changed according to some algorithms. Samples are

placed in temperature ramping ovens and pulled at various time points. The study realized by A. OLIVA and al. shows an example of non-isothermal application and compares it with the isothermal method. Samples are put in an oven with linear increasing temperature program: heating rate of 0.25°C/h and a temperature interval of 40°C to 80°C.

Non-isothermal studies require a linear or non linear regression by previous data transformation to estimate the parameters. Two popular approaches are derivative and integral.

This method will need suitable experimental designs and precise dosage form content assays to provide reliable parameter estimates.

Analysis of isothermal kinetic experiments is traditionally more reliable because the temperature is held constant during each experiment, thereby reducing the number of kinetic parameters to be determined simultaneously by fitting. However, BD does not own an oven capable to program temperature rises. The need of a specific statistical program is also required for this kind of analysis. The non-isothermal method was therefore not implemented during this internship.

A protocol, based on isothermal studies, was then sat. It lists tests that can be done to determine whether the active ingredient is sensitive or not facing several formulation parameters: different oxygen levels during formulation, different pH values, but also heat variations (temperatures above 40°C), light exposition and packaging impact (see Appendix 2).

- Acid or basic strong hydrolysis tests are not necessary as pre-formulation stress tests will be performed on formulations with buffer or pH adjuster. No major pH variations are susceptible to occur. But the robustness of a determined pH against external environment will be evaluated.
- Test with pH variation is set to determine, in the pH USP range of the API, the most stable formulation. Stability data will be compared between several formulations with different pHs adjustment.



- During oxidation tests, stability data are compared between a formulation performed under air and a formulation done under nitrogen. When put in the immediate atmosphere of the solution, nitrogen, as an inert gas, can protect formulations from oxidation reactions,
- The rubber compatibility test helps determine if the formulation will be stable in syringes. The formulation and syringes components interaction will be studied.
- The suntest is aimed at determining the formulation stability facing light exposure. This test will follow ICH guidance specifications.
- The heat tests are set to determine if the formulation can withstand steam sterilization. Formulation samples will be exposed to 1 and/or 2 autoclave cycle of 121°C during 20 minutes.

Heat sensitivity will also be taken into account when the formulation is put at high temperatures to accelerate the degradation reaction kinetic, in previously described tests.

During this eight months study, some tests were performed in the formulation laboratory following the establishment of the work instruction.

These tests had two main purposes:

- To better understand physical phenomenon linked to active ingredient's sensitivity and degradation comparatively to theoretical data;
- To prepare the establishment of pre-stability tests that will be launched in routine for all dosage forms developed by the team. Conditions of tests could evolve after first results of stress degradation experiments. The chemical structure of the active ingredient is to be taken into account.

## 2.2 STABILITY STUDY OF X INJECTION SOLUTION

Before any laboratory work application, bibliographic research on the active ingredient chosen to undergo stress degradations tests is done. This research is essential to get familiar with its potential sensitivity. It will also permit to underline what is not quoted in literature and will therefore be probably the subject of stability tests.

Studies described here are performed on a drug X, the first active ingredient chosen to undergo pre-formulation forced degradation.

The literature explains that the major degradation pathway of X is oxidation. Indeed, the oxygen exposition of X will lead to its major degradation. But a pH adjustment not appropriated and light or heat exposure can also be responsible of impurities formation.

According to the European Pharmacopeia, the active ingredient X can generate eight different impurities named from A to H. Some are synthesis impurities and others are degradation impurities. The two first scorers obtained by the degradation of X are the impurity B, the dimerisation product of X and the impurity F, X-N-oxide. The degradation pathways of X to create these two impurities are as follow:

Impurity B:

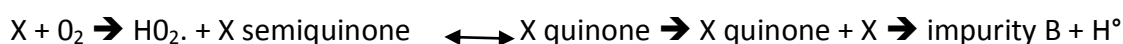

Impurity F:

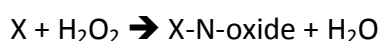
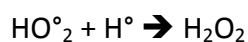

The two impurities are created by oxidation first. The oxidation reaction occurs on the phenolic group presented in the structure of X and gives the impurity B firstly; the second oxidation occurs on the tertiary amine group and gives the impurity F.

It will be important to watch their apparition during the following stress degradations studies.

It is to be noted that another dimerisation may occur during the degradation of X producing a polymer ether (C-O-C) not referenced in known impurities. This compound may be responsible for a yellowish to brown discoloration that could be observed during storage.

Moreover, researches about parameters that may influence the sensitivity of X gives important data useful to start stress degradation tests:

- First of all, USP pH range for this API is from 2.5 to 6.5, X is more stable in that range of pH. Regarding dosage forms already on market, the most are formulated at pH 5.0 but some publications explain that this active ingredient is more stable at acidic pH notably pH 4.0.
- The active ingredient X splits in two parts when exposed to day light.
- Some bibliographic data about the oxygen impact on the compound X showed that nitrogen was used during the formulation and help protect X against oxidation but others didn't mention about this aspect.
- Data about the sterilization process were found:

One publication mentioned the fact that X at a concentration of 1 mg/mL packaged in polypropylene bags (PP), sterilized at 121°C during 20 minutes and monitored at 25°C for 3, 6, 12, 18, 24 and 36 months, 30°C and 40°C for 3 and 6 months was found stable for 3 years in PP IV bags.

Another publication studied heat and oxygen influence on an injection solution of X preservative free at a concentration of 40 mg/mL with and without autoclaving. The formulation was found stable during steam sterilization at 121°C for up to 15 minutes and even up to 180 minutes for the solution adjusted at a pH of 3.2.

## 3 STUDIES AT LABORATORY SCALE

### 3.1 INTRODUCTION

Given information obtained about the sensitivity of X, three first tests were planned. The first one will help determine the optimum pH for the stability of X in solution at a concentration of 10 mg/mL and the impact of oxygen on that stability.

The second test will assess the impact of autoclaving on the formulation. It will help determine a process between aseptic formulation and steam sterilization for an injection solution of X.

The third test will help evaluate the stability of the injection solution of X when put in contact with three different references of rubber used as stopper and tip-cap in BD Hypack® SCF syringes.

After having pooled together those three tests results there was still a doubt on the sterilization process to employ. A final test was then set to clear this aspect. It was useful to determine if the non-isothermal method employed for stress degradation tests was representative and could be extrapolated at 25°C.

Results for those tests will be detailed in the section 3.2. Standard deviations were calculated. As some analyses were done only one time, it was not possible to calculate it for all experiences.

The active ingredient X, developed at five different concentrations, will be tested at 10 mg/mL, the strongest dosage developed, because the more concentrate the formulation is, the more degradation and stability differences can be evaluated. A solution of X at 2 mg/mL, the smallest dosage, will be chosen in a second time since the lowest concentration is considered as the worst case. Impurities are more visible with this lowest concentration permitting more precise stability estimation.

Table III summarizes theoretical solution formulas used for those studies.

Table III: Unit and batch formulas for X at 10 mg/mL and at 2 mg/mL

Material	Function	X 10 mg/mL		X 2 mg/mL
		For 1 mL	For 1 L	For 1 L
X	API	10 mg	10 g	2 g
Sodium chloride	Isotonic agent	8.4 mg	8.4 g	9.0 g
Hydrochloric acid 0.1 N	pH adjuster	Sqf pH	Sqf pH	Sqf pH
Sodium hydroxide 0.1 N	pH adjuster	Sqf pH	Sqf pH	Sqf pH
Purified Water	solvent	Sqf 1 mL	Sqf 1 L	Sqf 1 L

*sqf: sufficient quantity for*

As the formulation doesn't contain a buffer, formulations' pHs were adjusted using various quantities of Hydrochloric acid and Sodium hydroxide 0.1 N in order to reach the required pH between the range 2.5 to 6.5.

To check formulations' stability, several parameters were measured. They are listed in the table below with their tentative acceptance criteria.

Table IV: Tests performed and acceptance criteria

Tests	Acceptance criteria
Appearance	Clear and colorless
Visual inspection	0 visible particles
pH	2.5 to 6.5
O <sub>2</sub> partial pressure	For information
Osmolality	For information
Assay by UV*	90.0 % – 110.0 %
API Assay by UPLC	90.0 % – 110.0 %
Impurities by UPLC	Known impurities: NMT 0.2 % Unknown impurities: NMT 0.2 %

Sum of impurities: NMT 1.0 %
------------------------------

*\*To perform assays, both UV and UPLC were used in the first study in order to correlate data between the two methods. But as UV data does not give information on impurity content, only UPLC analysis for assay and impurities was pursued. Indeed UPLC is a method that gives more complete and precise data about impurities as it is a separative technique, thus, UV analyze was not considered anymore for the other tests.*

After stress stability storage, the O<sub>2</sub> partial pressure was controlled to detect if it remains some oxygen in the packaging during the time of test. This measurement was done with an ABL5 (from Radiometer). It measures the partial pressure in mmHg thanks to an amperometric electrode.

## 3.2 PH AND OXYGEN IMPACT ON X 10 MG/ML INJECTION STABILITY.

### 3.2.1 MATERIAL AND METHOD

The aim of this first study was to determine the optimum pH for the stability of an injection solution with X at a concentration of 10 mg/mL and to assess the impact of oxygen on that stability.

pHs between 2.5 and 6.5 were chosen to be studied as previously explained in section 2.2. Formulations were adjusted at pH 2.5, 4.0, 5.0 and 6.5 to determine the most favorable pH for the stability of X.

Two different formulations were also performed: one under air, the other under nitrogen. This will help determine the sensitivity of X to oxygen and the effect of inerting.

Samples were prepared as follow:

- Solutions were stored in 10 mL amber vials, to prevent from a potential dimerisation of X due to light, as reported in literature, with chlorobutyl-isoprene Teflon-faced top and hermetic aluminum seal to be impermeable to external environment,
- Two different atmosphere conditions: one under nitrogen, the other under air,
- pH of each solution was adjusted at 2.5, 4.0, 5.0 and 6.5,
- Vials of inerted and non inerted formulations were then divided into two studies for each pH:
  - Storage at 80°C during 2 and 6 weeks in an oven,
  - Storage at 40°C/75 % RH during 2 and 4 weeks in a climatic chamber

The 80°C condition was chosen to accelerate the degradation rate and to give quick results. Higher temperatures would not be recommended, because 80°C is the maximum temperature that can be applied without risking a non representative degradation.

The test at 40°C/75 % RH, condition usually used for pre-stability studies, was added in order to give additional data about formulations degradation behavior. Results will also be compared to 80°C stability profile in order to estimate if the high temperature is representative of a normal degradation profile.

Thus there were five samples for each condition as summarized in Table V.

Table V: 80°C and 40°C/75 % RH samples and conditions of storage

	pH	Study duration for 40°C/75% RH			Study duration for 80°C		
Air formulation	2.5	T0	T2W	T4W	T0	T2D	T6D
	4.0						
	5.0						
	6.5						
Nitrogen formulation	2.5	T0	T2W	T4W	T0	T2D	T6D
	4.0						
	5.0						
	6.5						

W: Week; D: Day

The solution that required inerting was entirely formulated in an Atmosbag® (plastic airtight pocket). This technique guarantees an atmosphere mostly free of oxygen after degassing three times the atmosbag with nitrogen.

The oxygen residual concentration was measured, during the formulation, with an oxygen meter (polarographic oxygen probe immersed in the solution). It measures the concentration in ppm. In order to qualify a solution as correctly inerted, the residual concentration of oxygen needs to be around 0.02 ppm.

After formulation, vials dedicated to 40°C/75 % RH were put in a climatic chamber (40°C/75 % RH). As the molecule is already dissolved in water, the 75 % of Relative Humidity has no impact on the possible degradations reactions.

Vials dedicated to 80°C study were put in an oven at that temperature.



### 3.2.2 RESULTS AND DISCUSSION

Typical chromatograms to illustrate this study API assay and impurities analysis are presented in Appendix 3 and Appendix 4.

First of all, the 80°C results will be presented while the results at 40°C/75 % RH will be developed afterwards.

Discussion and conclusion about this test will be treated right after.

#### 3.2.2.1 FORCED DEGRADATION RESULTS AT 80°C

Results for the forced degradation tests at 80°C on a solution of X at a concentration of 10 mg/mL are detailed in Table VI and Table VII. Only UV and pH trends are presented with standard deviations. Other analyses were done only once.

##### Air formulation appearance:

- All the solutions after 2 days at 80°C were slightly yellow whatever the pH.
- All the solutions after 6 days at 80°C were yellow with deeper color for the formulation at pH 6.5.

##### Nitrogen formulation appearance:

- All the solutions after 2 days at 80°C were slightly pale yellow whatever the pH.
- All the solutions after 6 days at 80°C were also slightly pale yellow whatever the pH.
- For both, the color was really less deep than formulations under air.

## Studies at laboratory scale

Table VI: Forced degradations results for formulation under air at 80°C

Analytical tests	Specifications	RRT	Formulation under air											
			pH 2.5			pH 4.0			pH 5.0			pH 6.5		
			T0	T2D	T6D	T0	T2D	T6D	T0	T2D	T6D	T0	T2D	T6D
Appearance	Clear and colorless	-	C	NC	NC	C	NC	NC	C	NC	NC	C	NC	NC
Visual inspection	0 visible particles	-	C	C	C	C	C	C	C	C	C	C	C	C
pH	USP range (2.5 ≤ pH ≤ 6.5)	-	2.61	2.60	2.60	4.03	3.88	3.73	5.14	4.17	3.81	6.47	5.87	4.66
Osmolality (mOsm)	For information	-	303			299			299			300		
X assay by UV (mg/mL and %)	9.0 - 11.0 mg/mL	-	10.4	10.0	10.3	10.0	10.1	10.2	10.0	10.4	10.1	10.0	10.0	10.4
	90 % - 110 %	-	104	100	103	100	101	102	100	104	101	100	100	104
X assay by UPLC (mg/mL and %)	9.0 - 11.0 mg/mL	-	10.04	9.80	9.60	10.04	9.97	9.84	10.05	9.52	9.82	9.92	9.61	9.51
	90 % - 110 %	-	100.4	98.0	96.0	100.4	99.7	98.4	100.5	95.2	98.2	99.2	96.1	95.1
Total of impurities by UPLC (%)	NMT 1.0 %	-	ND	3.49	6.04	ND	1.94	2.72	ND	1.56	2.17	ND	1.64	2.44
Impurity A	NMT 0.2 %	1.37	ND	0.04	ND	ND	0.03	ND	ND	0.05	ND	ND	0.06	ND
Impurity B	NMT 0.2 %	1.24	ND	2.61	4.55	ND	1.34	1.72	ND	1.04	1.40	ND	0.85	1.11
Impurity C	NMT 0.2 %	-	ND	ND	ND	ND	ND	ND	ND	ND	ND	ND	ND	ND
Impurity D	NMT 0.2 %	0.37	ND	0.10	0.13	ND	0.05	0.06	ND	0.06	0.05	ND	0.09	0.06
Impurity E	NMT 0.2 %	1.11	ND	0.34	0.33	ND	0.14	0.12	ND	0.09	0.09	ND	ND	ND
Impurity F	NMT 0.2 %	1.06	ND	0.04	0.05	ND	0.08	0.08	ND	0.04	0.06	ND	0.32	0.60
Impurity G	NMT 0.2 %	5.36	ND	ND	ND	ND	ND	ND	ND	ND	ND	ND	0.09	0.14
Impurity H	NMT 0.2 %	-	ND	ND	ND	ND	ND	ND	ND	ND	ND	ND	ND	ND
Unknown	NMT 0.2 %	0.16	ND	0.02	0.04	ND	0.06	0.28	ND	0.08	0.27	ND	0.10	0.30
Unknown	NMT 0.2 %	1.09	ND	0.08	0.50	ND	0.08	0.28	ND	0.07	0.15	ND	ND	0.09
Unknown	NMT 0.2 %	1.45	ND	0.26	0.44	ND	0.16	0.18	ND	0.13	0.15	ND	0.13	0.14

C/NC: Reported as “C” if no change or matter is observed in solution appearance and clarity. If any change or matter is observed, “NC” is reported. ND: not detected.

## Studies at laboratory scale

Table VII: Forced degradations results for formulation under nitrogen at 80°C

Analytical tests	Specifications	RRT	Formulation under nitrogen											
			pH 2.5			pH 4.0			pH 5.0			pH 6.5		
			T 0	T2D	T6D	T0	T2D	T6D	T0	T2D	T6D	T0	T2D	T6D
Appearance	Clear and colorless	-	C	NC	NC	C	NC	NC	C	NC	NC	C	NC	NC
Visual inspection	0 visible particles	-	C	C	C	C	C	C	C	C	C	C	C	C
pH	USP range (2.5 < pH < 6.5)	-	2.57	2.61	2.61	3.98	4.04	4.08	5.11	5.10	5.14	6.54	6.43	6.42
PO <sub>2</sub> (mmHg)	For information	-	18	17	15	18	16	15	18	15	15	18	15	15
Osmolality (mOsm)	For information	-	305			299			298			299		
X assay by UV (mg/mL and %)	9.0 - 11.0 mg/mL 90 % - 110 %	-	10.4	10.0	10.0	10.0	9.7	9.6	10.0	10.0	10.0	10.0	9.8	10.3
			104	100	100	100	97	96	100	100	100	100	100	98
X assay by UPLC (mg/mL and %)	9.0 - 11.0 mg/mL 90 % - 110 %	-	10.06	10.20	10.15	9.99	10.24	8.50	9.94	9.98	9.32	10.06	10.13	9.37
			100.6	102.0	101.5	99.9	102.4	85.0	99.4	99.8	93.2	100.6	101.3	93.7
Total of impurities by UPLC (%)	NMT 1.0 %	-	<b>ND</b>	<b>0.27</b>	<b>0.30</b>	<b>ND</b>	<b>0.28</b>	<b>0.18</b>	<b>ND</b>	<b>0.23</b>	<b>0.19</b>	<b>ND</b>	<b>0.22</b>	<b>0.21</b>
Impurity A	NMT 0.2 %	1.37	ND	0.05	0.05	ND	0.06	0.04	ND	0.06	0.05	ND	0.06	0.05
Impurity B	NMT 0.2 %	1.24	ND	0.11	0.09	ND	0.08	0.06	ND	0.09	0.06	ND	0.04	0.03
Impurity C	NMT 0.2 %	-	ND	ND	ND	ND	ND	ND	ND	ND	ND	ND	ND	ND
Impurity D	NMT 0.2 %	0.37	ND	0.04	0.05	ND	0.05	0.06	ND	0.04	0.06	ND	0.06	0.10
Impurity E	NMT 0.2 %	1.11	ND	0.04	0.04	ND	ND	ND	ND	ND	ND	ND	ND	ND
Impurity F	NMT 0.2 %	1.06	ND	0.03	0.04	ND	0.05	0.02	ND	0.04	0.02	ND	0.06	0.03
Impurity G	NMT 0.2 %	-	ND	ND	ND	ND	ND	ND	ND	ND	ND	ND	ND	ND
Impurity H	NMT 0.2 %	-	ND	ND	ND	ND	ND	ND	ND	ND	ND	ND	ND	ND
Unknown	NMT 0.2 %	1.45	ND	ND	0.03	ND	0.04	ND	ND	ND	ND	ND	ND	ND

C/NC: Reported as "C" if no change or matter is observed in solution appearance and clarity. If any change or matter is observed, "NC" is reported. ND: not detected

## Studies at laboratory scale



### 80°C SAMPLES PH TRENDS

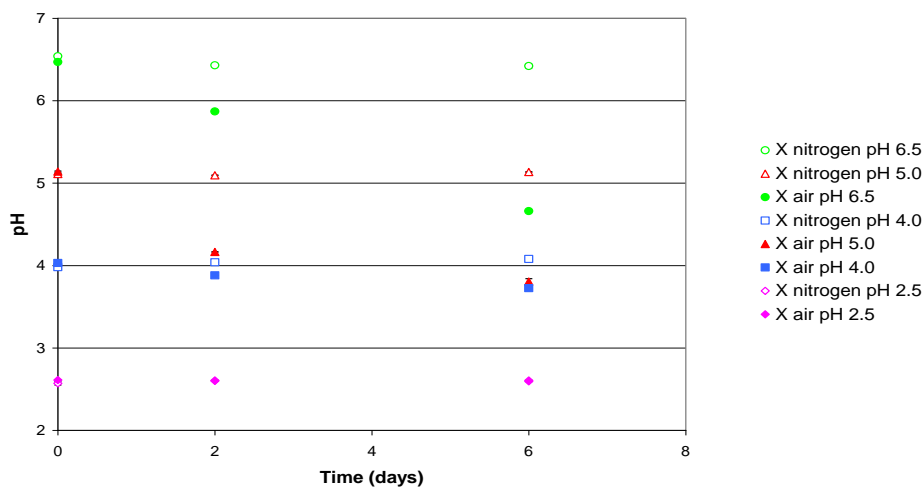

Figure 7: X 10 mg/mL, pH trend, 80°C

Among solutions formulated under air, the results obtained at pH 6.5 and 5.0 showed the biggest decrease. pH 4.0 decreased but in a minor way and pH 2.5 remained stable.

All the formulations remained stable when formulated under nitrogen.



### 80°C SAMPLES ASSAY TRENDS, ANALYZED BY UV

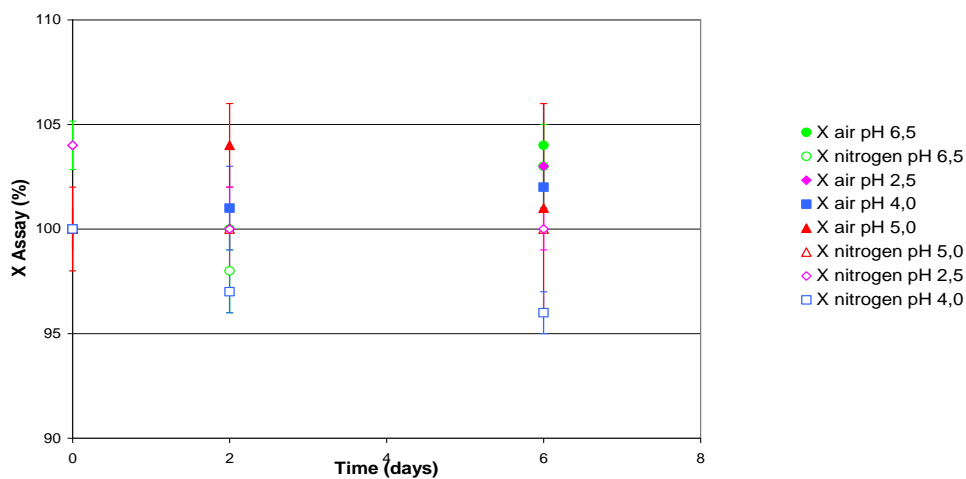

Figure 8: X 10 mg/mL API assay trend by UV, 80°C

## Studies at laboratory scale

No significant change can be noticed in the UV API assay where all data were in specifications and seemed relatively stable over time.

### ➤ *80°C SAMPLES ASSAY TRENDS, ANALYZED BY UPLC*

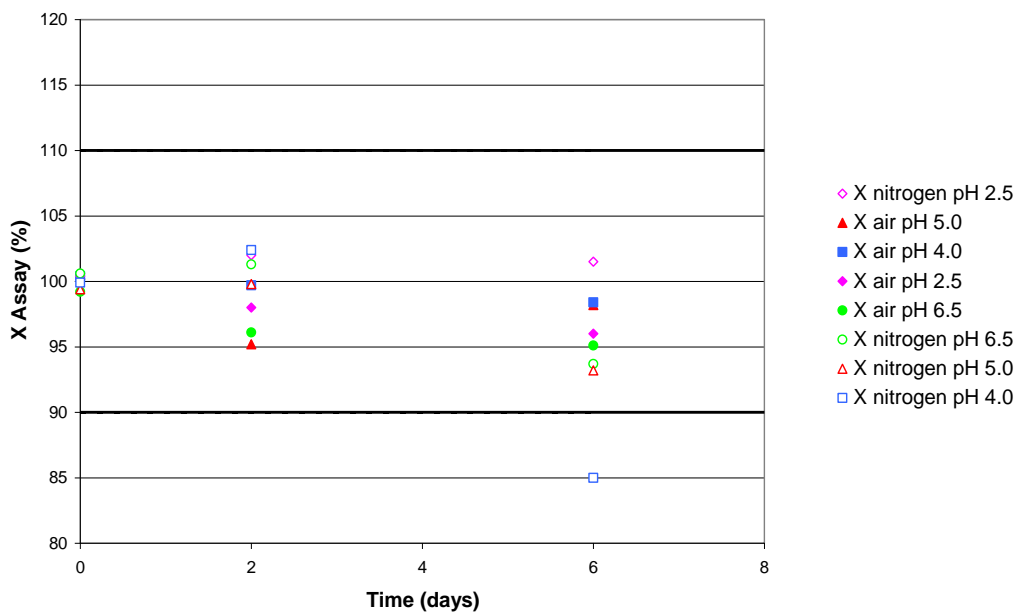

Figure 9: X 10 mg/mL API assay trend by UPLC, 80°C

Formulations at pH 6.5 and pH 5.0 performed under nitrogen showed, after 6 days at 80°C, a significant decrease with differences higher than 5 % between T2D and T6D values but all data stayed in specifications.

The point pH 4.0 under nitrogen stored 6 days was aberrant as no other tests performed on this sample showed this kind of degradation. In addition, UV assay for the same condition was within specifications (see Figure 8 and Table VII).

## Studies at laboratory scale



### 80°C SAMPLES IMPURITIES ASSAY TRENDS, ANALYZED BY UPLC

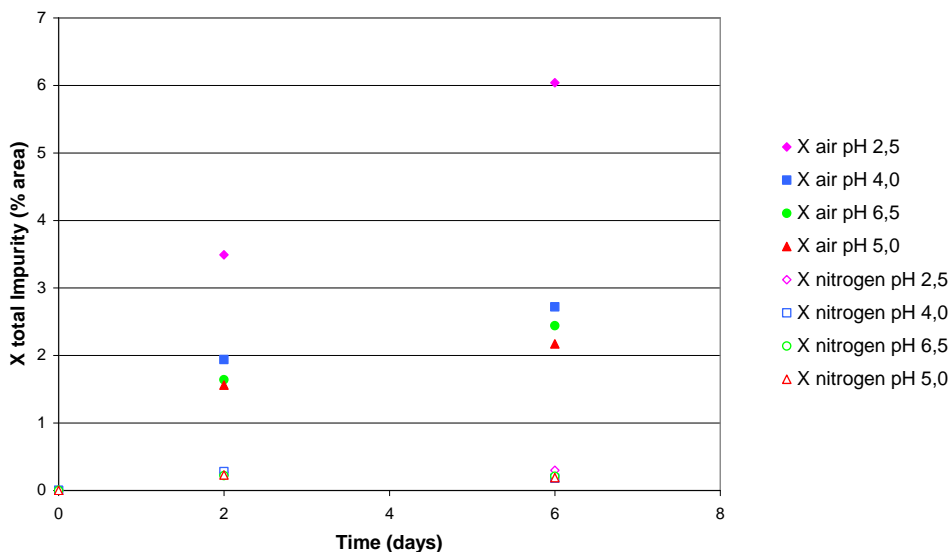

Figure 10: X 10 mg/mL impurities assay trend by UPLC, 80°C

The amount of impurities was significantly higher in formulations performed under air. The formulation under air at pH 2.5 showed obviously the highest level of impurities with an accelerated increase after 6 days, other air formulations had fewer differences in their value and presented a constant increase. Nitrogen formulations values stayed constant.

### 3.2.2.2 FORCED DEGRADATION RESULTS AT 40°C/75 % RH

Results for the forced degradation study at 40°C/75 % RH on a solution of X at 10 mg/mL are detailed in Table VIII and Table IX. Only pH trends are presented with standard deviations.

#### Air formulation appearance:

- All the solutions at pH 2.5 stayed clear and colorless.
- The solutions at pH 4.0 stayed colorless when stored 2 weeks at 40°C/75 % RH but turned to a pale yellow after 4 weeks at 40°C/75 % RH.

### Studies at laboratory scale

- Samples at pH 5.0 turned to a pale yellow when stored 2 weeks at 40°C/75 % RH then the color became deeper after 4 weeks. The color was deeper than pH 4.0 but remained light.
- The solutions at pH 6.5 changed to yellow as the sample at pH 5.0 but with a deeper color.

### Nitrogen formulation appearance:

- All the solutions at pH 2.5 stayed clear.
- Solutions at pH 4.0 turned to a pale yellow after 4 weeks at 40°C/75 % RH.
- The samples at pH 5.0 turned to a pale yellow after 2 weeks stored at 40°C/75 % RH. The color became deeper after 4 weeks at 40°C/75 % RH, deeper than pH 4.0 but still light.
- Solutions adjusted at pH 6.5 turned to yellow as the solution at pH 5.0 but with a deeper color.

Generally speaking, the coloration was lighter for formulations under nitrogen than for formulations under air but both presented a color variation with time.

Studies at laboratory scale

Table VIII: Forced degradation results for formulation under air at 40°C/75 % RH

Analytical tests	Specifications	RRT	Formulation under air											
			pH 2.5			pH 4.0			pH 5.0			pH 6.5		
			T0	T2W	T4W	T0	T2W	T4W	T0	T2W	T4W	T0	T2W	T4W
Appearance	Clear and colorless	-	C	C	C	C	C	NC	C	NC	NC	C	NC	NC
Visual inspection	0 visible particles	-	C	C	C	C	C	C	C	C	C	C	C	C
pH	USP range (2.5 < pH < 6.5)	-	2.61	2.56	2.55	4.03	4.03	3.95	5.14	4.82	4.64	6.47	6.31	6.15
Osmolality (mOsm)	For information	-	304			299			299			300		
X assay by UV (mg/mL and %)	9.0 - 11.0 mg/mL 90 % - 110 %	-	10.4 104	10.3 103	NT	10.0 100	10.3 103	NT	10.0 100	10.2 102	NT	10.0 100	10.3 103	NT
X assay by UPLC (mg/mL and %)	9.0 - 11.0 mg/mL 90 % - 110 %	-	10.04 100.4	9.95 99.5	9.98 99.8	10.04 100.4	9.88 98.8	9.93 99.3	10.05 100.5	10.01 100.1	9.93 99.3	9.92 99.2	9.82 98.2	9.92 99.2
Total of impurities by UPLC (%)	NMT 1.0 %	-	<b>ND</b>	<b>1.16</b>	<b>2.01</b>	<b>ND</b>	<b>1.19</b>	<b>1.87</b>	<b>ND</b>	<b>1.24</b>	<b>1.68</b>	<b>ND</b>	<b>1.85</b>	<b>2.17</b>
Impurity A	NMT 0.2 %	1.37	ND	0.04	0.05	ND	0.03	0.05	ND	0.05	0.05	ND	0.05	0.05
Impurity B	NMT 0.2 %	1.24	ND	0.87	1.55	ND	0.86	1.41	ND	0.96	1.38	ND	1.45	1.57
Impurity C	NMT 0.2 %	-	ND	ND	ND	ND	ND	ND	ND	ND	ND	ND	ND	ND
Impurity D	NMT 0.2 %	0.36	ND	0.06	0.08	ND	0.06	0.06	ND	0.05	0.06	ND	0.08	0.09
Impurity E	NMT 0.2 %	1.11	ND	0.10	0.19	ND	0.10	0.17	ND	0.07	0.08	ND	ND	ND
Impurity F	NMT 0.2 %	1.06	ND	0.05	0.05	ND	0.04	0.07	ND	0.07	0.05	ND	0.15	0.22
Impurity G	NMT 0.2 %	5.36	ND	ND	ND	ND	ND	ND	ND	ND	ND	ND	ND	0.09
Impurity H	NMT 0.2 %	-	ND	ND	ND	ND	ND	ND	ND	ND	ND	ND	ND	ND
Unknown	NMT 0.2 %	0.16	ND	ND	ND	ND	0.05	0.04	ND	ND	ND	ND	ND	ND
Unknown	NMT 0.2 %	1.08	ND	ND	ND	ND	ND	ND	ND	ND	ND	ND	0.07	0.10
Unknown	NMT 0.2 %	1.45	ND	0.04	0.06	ND	0.05	0.07	ND	0.04	0.06	ND	0.05	0.05

C/NC: reported as “C” if no change or matter is observed in solution appearance and clarity. If any change or matter is observed, “NC” is reported. ND: Not Detected, NT: Not Tested



## Studies at laboratory scale

Table IX: Forced degradation results for formulation under nitrogen at 40°C/75 % RH

			Formulation under nitrogen											
Analytical tests	Specifications	RRT	pH 2.5			pH 4.0			pH 5.0			pH 6.5		
			T0	T2W	T4W	T0	T2W	T4W	T0	T2W	T4W	T0	T2W	T4W
Appearance	Clear and colorless	-	C	C	C	C	C	NC	C	NC	NC	C	NC	NC
Visual inspection	0 visible particles	-	C	C	C	C	C	C	C	C	C	C	C	C
pH	USP range (2.5 < pH < 6.5)	-	2.57	2.58	2.58	3.98	4.00	4.02	5.11	5.02	5.05	6.54	6.43	6.41
PO <sub>2</sub> (mmHg)	For information	-	18	22	27	18	22	25	18	21	23	18	19	21
Osmolality (mOsm)	For information	-	305			299			298			299		
X assay by UV (mg/mL and %)	9.0 - 11.0 mg/mL 90 % - 110 %	-	10.4 104	10.2 102	NT	10.0 100	10.3 103	NT	10.0 100	10.2 102	NT	10.0 100	10.5 105	NT
X assay by UPLC (mg/mL and %)	9.0 - 11.0 mg/mL 90 % - 110 %	-	10.06 100.6	10.07 100.7	10.04 100.4	9.99 99.9	9.82 98.2	10.00 100.0	9.94 99.4	9.98 99.8	9.98 99.8	10.06 100.6	9.89 98.9	10.03 100.3
Total of impurities by UPLC (%)	NMT 1.0 %	-	<b>ND</b>	<b>0.38</b>	<b>0.42</b>	<b>ND</b>	<b>0.34</b>	<b>0.43</b>	<b>ND</b>	<b>0.40</b>	<b>0.30</b>	<b>ND</b>	<b>0.45</b>	<b>0.46</b>
Impurity A	NMT 0.2 %	1.37	ND	0.04	0.03	ND	0.05	0.05	ND	0.06	0.03	ND	0.06	0.05
Impurity B	NMT 0.2 %	1.24	ND	0.18	0.21	ND	0.17	0.18	ND	0.25	0.16	ND	0.26	0.20
Impurity C	NMT 0.2 %	-	ND	ND	ND	ND	ND	ND	ND	ND	ND	ND	ND	ND
Impurity D	NMT 0.2 %	0.6	ND	0.07	0.04	ND	0.04	0.05	ND	0.04	0.03	ND	0.08	0.08
Impurity E	NMT 0.2 %	1.12	ND	0.05	0.07	ND	0.03	0.10	ND	ND	ND	ND	ND	ND
Impurity F	NMT 0.2 %	1.06	ND	0.04	0.05	ND	0.05	0.03	ND	0.05	0.05	ND	0.05	0.05
Impurity G	NMT 0.2 %	-	ND	ND	ND	ND	ND	ND	ND	ND	ND	ND	ND	ND
Impurity H	NMT 0.2 %	-	ND	ND	ND	ND	ND	ND	ND	ND	ND	ND	ND	ND
Unknown	NMT 0.2 %	1.09	ND	ND	ND	ND	ND	ND	ND	ND	ND	ND	ND	0.05
Unknown	NMT 0.2 %	1.47	ND	ND	0.02	ND	ND	0.02	ND	ND	0.03	ND	ND	0.03

C/NC: reported as “C” if no change or matter is observed in solution appearance and clarity. If any change or matter is observed, “NC” is reported. ND: Not Detected, NT: Not Tested

## Studies at laboratory scale



### 40°C/75 % RH SAMPLES pH TRENDS

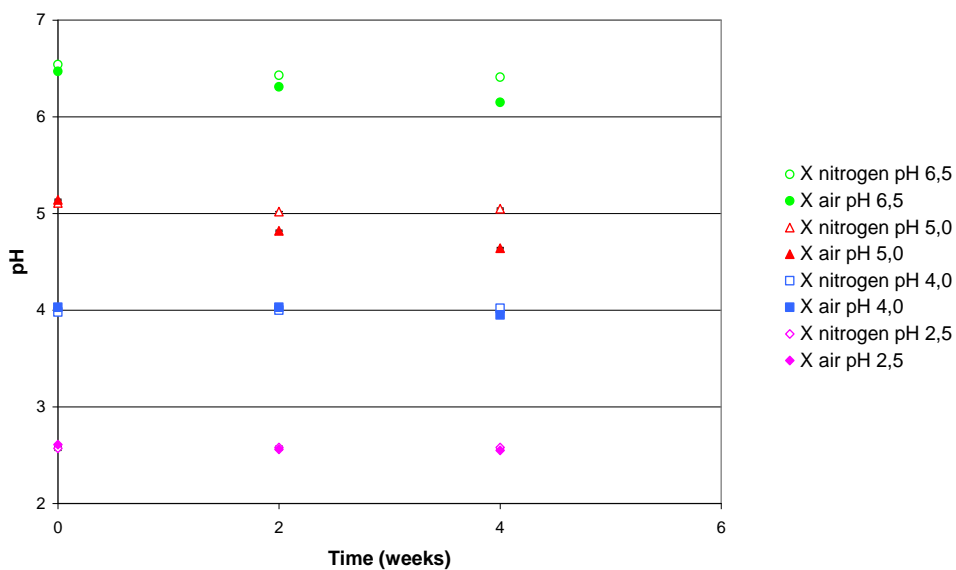

Figure 11: X 10 mg/mL pH trend, 40°C

pHs data showed the same tendency than the one obtained at 80°C: pH 6.5 and 5.0 showed a decrease when formulated under air but remained stable when formulated under nitrogen, while at pH 4.0 and 2.5 the solutions stayed stable for both formulation conditions.

## Studies at laboratory scale



### 40°C/75 % RH SAMPLES ASSAY TRENDS, ANALYZED BY UPLC

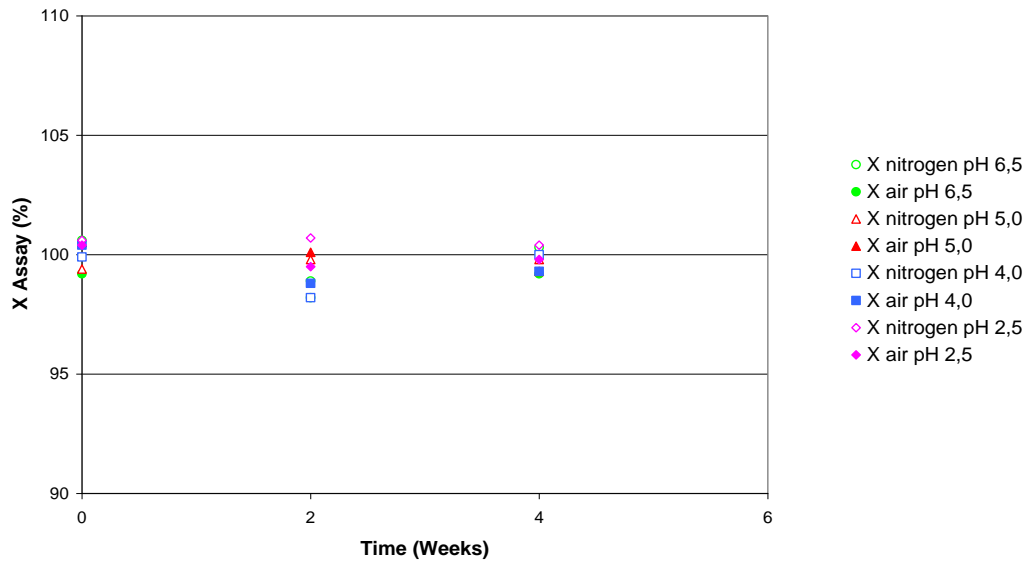

Figure 12: X 10 mg/mL API assay trend by UPLC, 40°C

No significant change in the UPLC API assay can be seen and all data were in specifications and very stable over time.



### 40°C/75 % RH SAMPLES IMPURITIES ASSAY TRENDS, ANALYZED BY UPLC

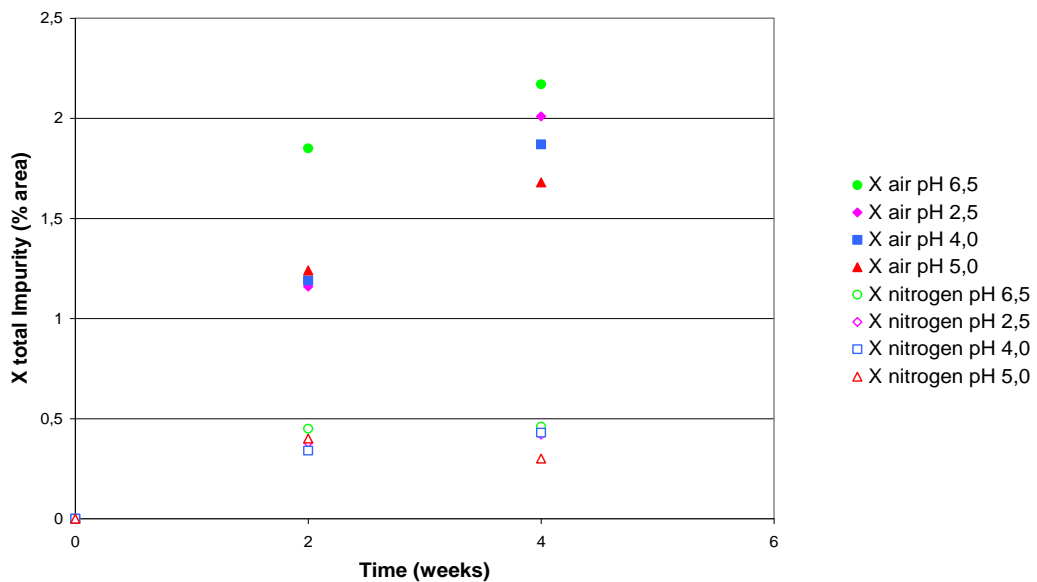

Figure 13: X 10 mg/mL impurities assay trend by UPLC, 40°C

## Studies at laboratory scale

This graph also confirms the data obtained at 80°C. The amount of impurities was significantly higher in formulations performed under air than in formulations performed under nitrogen.

But the results obtained at 40°C/75 % RH, are different from the ones observed at 80°C, it's the formulation under air at pH 6.5 that showed the highest level of impurities. One can also see a net value differences between air formulations at pH 4.0 and 5.0. pH 5.0 presents the lowest amount of total impurities.

### 3.2.2.3 DISCUSSION ON IMPURITIES

As previously discussed in bibliography, the two main degradation impurities to watch were the impurity B, the first scorer of the degradation of X (obtained due to oxidizing conditions, to heat or exposition to light) and the impurity F (obtained after submission to oxidizing conditions). The two were identified in this study.

Impurity E showed also an interesting behavior.

#### **Impurity B:** Dimerisation product of X

It was the main contributor to the high total impurities in all conditions for this study.

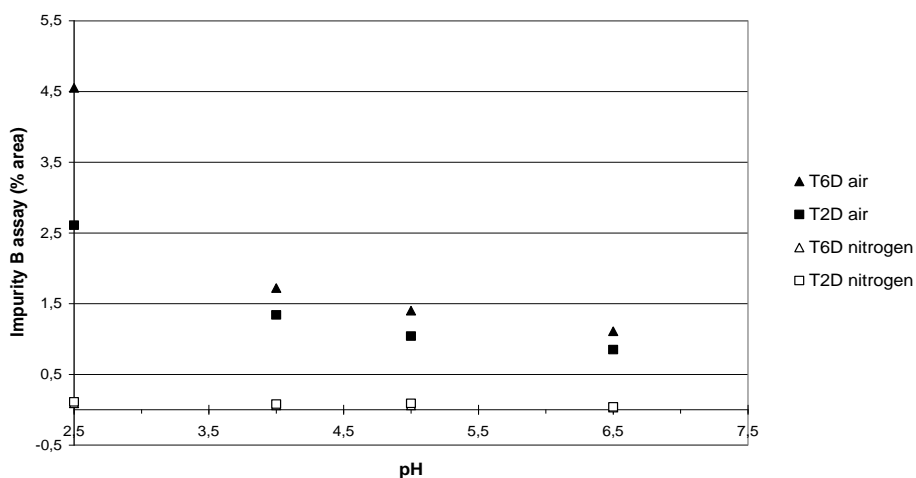

Figure 14: Impurity B UPLC assay in function of pH (80°C)

## Studies at laboratory scale

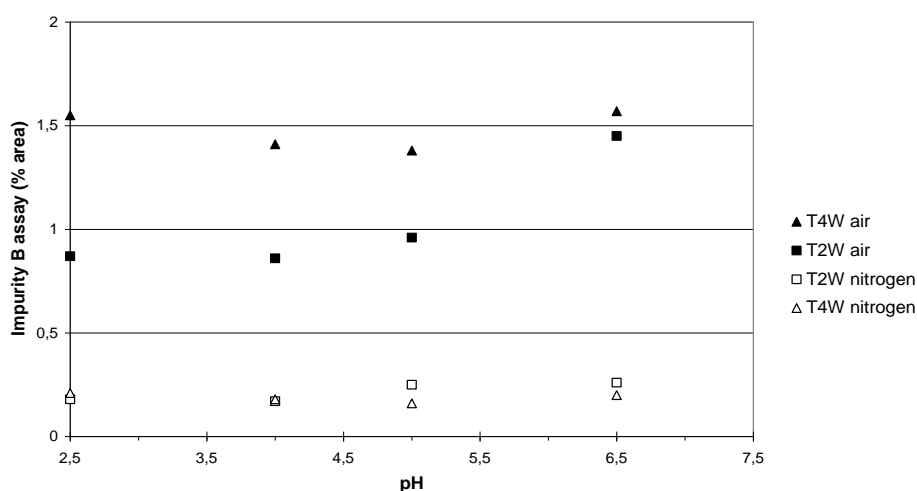

Figure 15: Impurity B UPLC assay in function of pH (40°C/75 % RH)

This impurity increased with time and temperature for the non-inerted batch.

At 80°C, the solution of X at pH 2.5 presented the largest amount of Impurity B. At 40°C/75 % RH the solution of X at pH 2.5 and 6.5 seem to be the conditions that promoted more the formation of this impurity B. At pH 4.0 and 5.0 a fewer content of Impurity B is observed.

Regarding the inerted batch, the amount of Impurity B was much lower and remained quite stable over time, regardless the temperature. Impurity B content was lower for 80°C conditions than for 40°C/75 % RH. It may have been degraded into other impurities at 80°C (no visible using the current UPLC method with UV detection). Another possibility is that a high humidity rate may increase the degradation of X.

Trends show that the formation of impurity B may be due to a combination of heat and oxidation.

## Studies at laboratory scale

### Impurity F: X-N-oxide

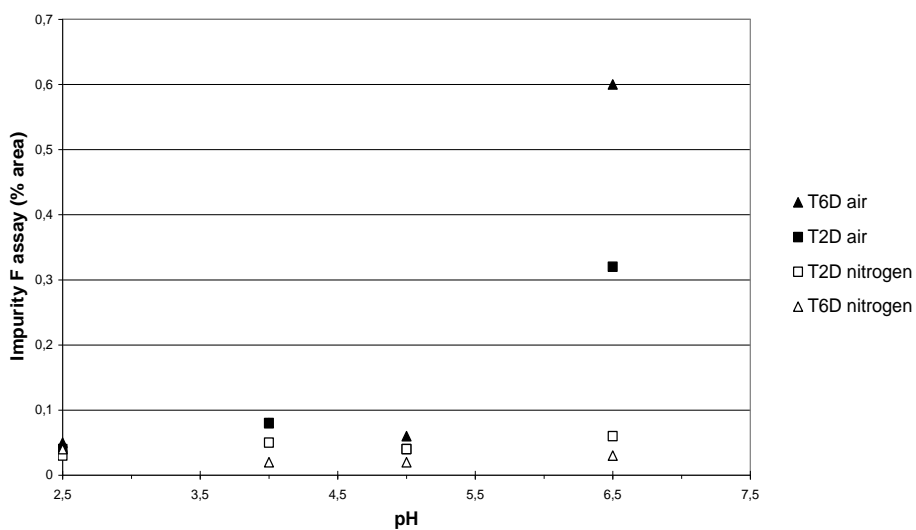

Figure 16: Impurity F UPLC assay in function of pH (80°C)

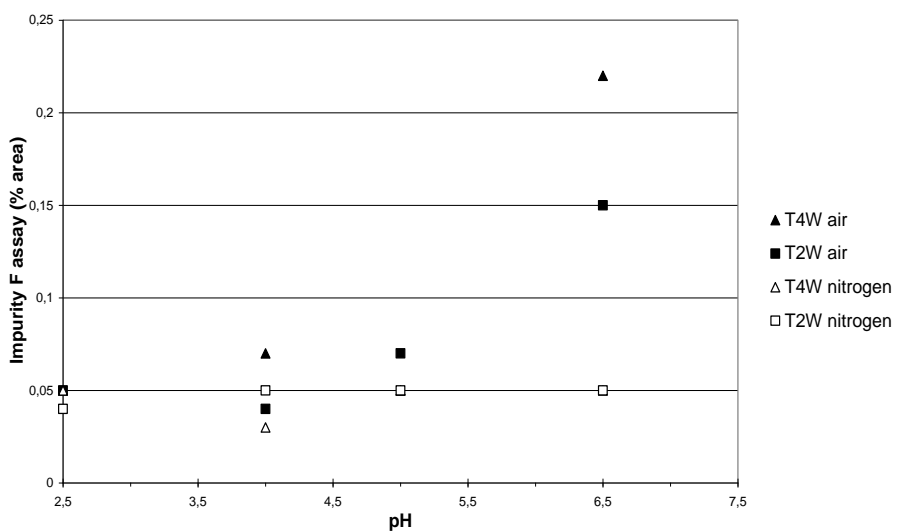

Figure 17: Impurity F UPLC assay function of pH (40°C/75 % RH)

The amount of impurity F was very low for the inerted formulations and remained stable overtime.

Regarding the non-inerted formulations, the impurity content stayed quite stable except for pH 6.5 where the content was higher and increased over time.

## Studies at laboratory scale

### **Impurity E:** X shape with a cetone instead of a hydroxyl- function

This impurity's behavior was interesting to watch as its content was strongly influenced by the conditions of the study.

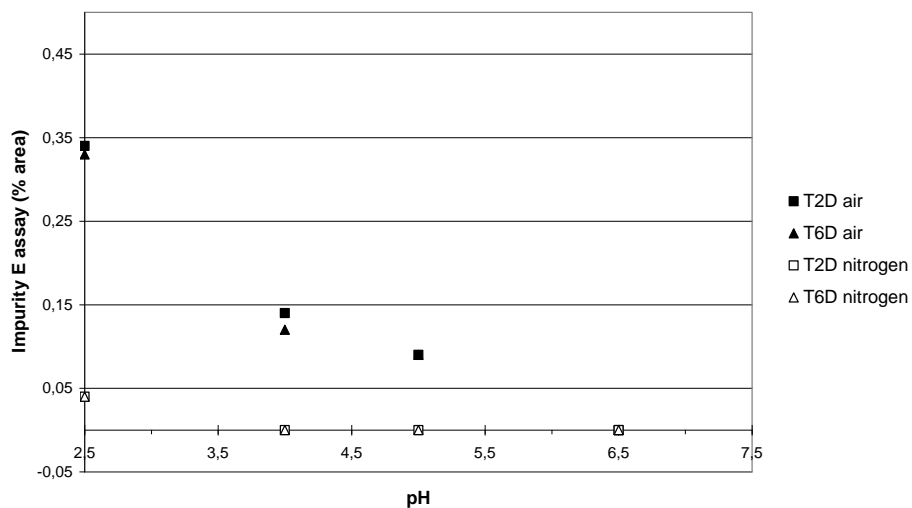

Figure 18: Impurity E UPLC assay in function of pH (80°C)

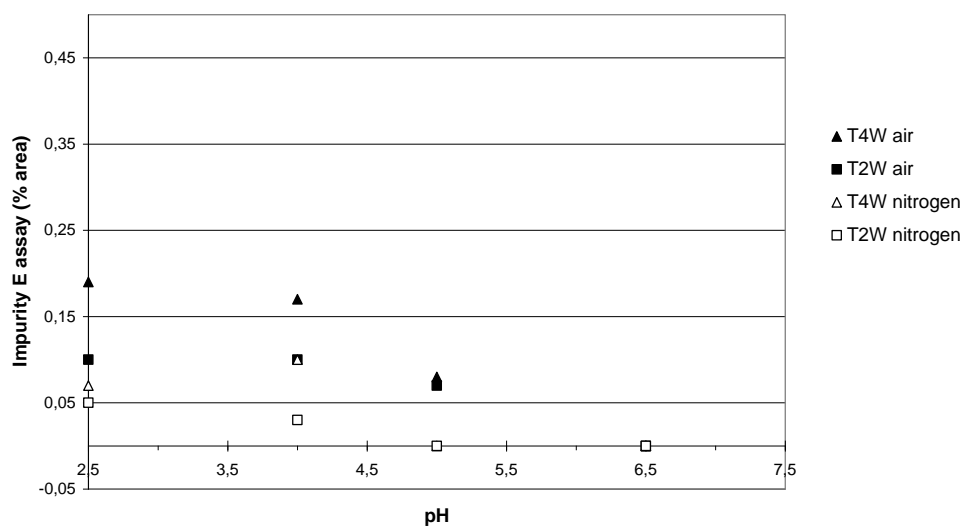

Figure 19: Impurity E UPLC assay in function of pH (40°C/75 % RH)

## Studies at laboratory scale

Contrary to Impurity B, Impurity E content presents the same trend whatever the storage temperature. Impurity E content was higher for pH 2.5 and seems more produced when the formulation was adjusted at acidic pH.

For other impurities identified during this study, their contents were low and stayed quite stable over time, regardless of the temperature, pH or conditions of formulations.

**Unknown impurities:** Three unknown impurities were produced during the study with RRT at 0.16, 1.09 and 1.45. They were mainly present in non-inerted formulations at the more stressful condition (80°C/T6D) for all pHs. Their concentration were higher for pH 2.5 (except for amounts of the impurity at RRT 0.16 which was higher at higher pHs) and increased over time. They were almost not detected at 40°C/75 % RH and in inerted formulations. A watch of these impurities would be to implement in other studies.

If we summarize results from inerted solutions comparatively to non inerted solutions:

- pHs from inerted solutions were most stable. pHs from non inerted solutions showed significant decrease, especially pH closer to neutrality.
- The amount of impurities was also significantly higher in formulations performed under air.
- All data were in specifications regarding the API UPLC assay. Formulations under nitrogen at pH 6.5 and 5.0 showed a decrease at 80°C. As the results at 40°C/75 % RH do not confirm this tendency, it may not be significant.

If we compare data obtained for the pH determination at 80°C:

- The solution at pH 6.5 and 5.0 showed the highest decrease when formulated under air, whereas they remained stable when formulated under nitrogen.
- The solution at pH 2.5 showed the highest level of impurities when formulated under air, while other pHs presented approximately the same impurities concentration.



## Studies at laboratory scale

Data obtained for the pH determination at 40°C/75 % RH:

- pHs curves showed the same trend as results obtained at 80°C upholding the fact that pH closer to neutrality were less stable when the formulation was done under air.
- Looking at impurities assay, the highest amount is obtained for pH 6.5 then pH 2.5 and after pH 4.0 and 5.0 present corresponding decreasing amounts.

Moreover, it can be noticed that impurities levels at 40°C/75 % RH after 4 weeks gave approximately the same amount than data obtained at 80°C after 6 days.

---

### 3.2.3 CONCLUSION

With this first study it has been demonstrated that data at 40°C/75 % RH gave the same results than data obtained at 80°C. This leads to the conclusion that conditions at 80°C were not too strong for the tested product and can be representative of a normal degradation.

Moreover, it is obvious, according to graphics interpretation that the formulation of X is more stable when submitted to inerted atmosphere. Nitrogen minimizes the oxidation effect and prevents from a too fast degradation.

The color evolution of each solution reflected a decrease in pH and an increase in impurity content. Indeed this discoloration may be related with further oxidation of an ether dimer different from Impurity B. However, no change in the results has been observed. This may indicate that despite the color change, the other parameters may still be within specification and the injection solution usable.

The X solutions will be stored in Hypak® SCF syringes. All pHs could be suitable for the formulation as they all are stable when formulated under nitrogen. As the oxygen content may increase in syringes over time, results obtained when the formulation is done under air have to be considered. Comparing results, pH 6.5 is removed because of its high level

### Studies at laboratory scale

of impurities when stored at 40°C/75 % RH during 4 weeks and because of its instability regarding pH curves (at both conditions).

Regarding its high level of impurities when stored at 80°C and 40°C/75 % RH and considering that 2.5 is very acid to formulate an injectable solution, it is preferable not to use it.

pH 4.0 and 5.0 were chosen to continue studies in order to collect more information about the formulation. The two pHs show the more stable assay of impurities, however pH 4.0 shows more impurities for the same conditions than pH 5.0. Further studies will permit to discriminate a pH.

### **3.3 X INJECTION AUTOCLAVABILITY STUDY AND PH DISCRIMINATION**

#### **3.3.1 MATERIAL AND METHOD**

The aim of this study was to assess the impact of autoclaving on an injection solution of X and to determine an optimum pH for the solution stability.

As previously discussed in chapter 3.1, the following concentrations, 10 mg/mL and 2 mg/mL have been chosen for the further tests.

Preliminary results from the first stress degradation study showed improved stability for the two intermediate pH conditions. Additional studies at pH 4.0 and 5.0 were performed here to determine which pH would be the most favorable for the stability of the X's formulation.

Autoclaving was also tested to decide which sterilization process can be applied to X.

Four different formulations were performed: 10 mg/mL at pH 4.0 and pH 5.0; 2 mg/mL at pH 4.0 and pH 5.0. The four solutions were formulated under nitrogen as previous studies showed improved stability for inerted formulations.

A filtration step was performed after formulation to get close to normal process conditions. The final process involves formulation filtration through 0.22 µm PVDF media filter to guarantee a better sterility essential for an injectable.

Samples were prepared as follow:

- 10 mg/mL and 2 mg/mL formulated under nitrogen,
- The pH of each formulation was adjusted at 4.0 and 5.0,
- Both formulations concentrations were then sampled in 10 mL amber vials (glass type 1) with chlorobutyl-isoprene Teflon-faced top and aluminum seal and put in the autoclave as described in Table X.

## Studies at laboratory scale

Table X: Autoclavability and pH determination study samples and conditions of stress

Formulation		Forced conditions
air formulation	BF	before filtration
	T0	Initial condition (after filtration)
	1C	undergo 1 autoclave cycle
	2C	undergo 2 autoclave cycles
nitrogen formulation	BF	before filtration
	T0	Initial condition (after filtration)
	1C	undergo 1 autoclave cycle
	2C	undergo 2 autoclave cycles

Some analyses were performed before and after filtration to check if the filtration process had no impact on the product (pH, API assay).

### 3.3.2 RESULTS AND DISCUSSION

The filtration study: comparison between sample before filtration (BF) and sample after filtration (see Appendix 5) showed no impact of the filtration on both formulations.

All trends are presented with standard deviation as each analyze was done twice or three times.

#### 3.3.2.1 X - 2 MG/ML FORCED DEGRADATION RESULTS

Results of the autoclave study on a solution of X at a concentration of 2 mg/mL, are detailed in Table XI.

X solution, concentration 2 mg/mL, appearance:

- Samples after filtration were clear and colorless,
- Appearance data after autoclave stress were omitted so no results were reported.

## Studies at laboratory scale

Table XI: Forced degradations results for X - 2 mg/mL

Analytical tests	Specifications	RRT	X - 2 mg/mL					
			pH 4.0			pH 5.0		
			T 0	1C	2C	T 0	1C	2C
Appearance	Clear and colorless	-	C	NR	NR	C	NR	NR
Visual inspection	0 visible particles	-	C	C	C	C	C	C
pH	USP range (2.5 ≤ pH ≤ 6.5)	-	4.09	4.13	4.15	5.30	5.46	5.51
PO <sub>2</sub> (mmHg)	For information	-	18	16	17	18	16	16
Osmolality (mOsm)	For information	-	334*			288		
X assay by UPLC (mg/mL)	1.80 - 2.20 mg/mL	-	2.01	2.02	2.02	1.99	1.98	1.98
X assay by UPLC (%)	90 % - 110 %	-	100.3	100.9	100.9	99.3	99.1	99.2
Total of impurities by UPLC (%)	NMT 1.0 %	-	<b>0.22</b>	<b>0.23</b>	<b>0.23</b>	<b>0.22</b>	<b>0.21</b>	<b>0.22</b>
Impurity A	NMT 0.2 %	1.41	0.04	0.05	0.05	0.05	0.05	0.06
Impurity B	NMT 0.2 %	1.28	0.01	0.02	0.02	0.01	ND	0.01
Impurity C	NMT 0.2 %	-	ND	ND	ND	ND	ND	ND
Impurity D	NMT 0.2 %	0.36	0.04	0.05	0.05	0.04	0.04	0.04
Impurity E	NMT 0.2 %	-	ND	ND	ND	ND	ND	ND
Impurity F	NMT 0.2 %	1.08	0.12	0.11	0.09	0.11	0.10	0.10
Impurity G	NMT 0.2 %	-	ND	ND	ND	ND	ND	ND
Impurity H	NMT 0.2 %	-	ND	ND	ND	ND	ND	ND
Unknown	NMT 0.2 %	1.50	0.02	0.02	0.02	0.02	0.02	0.02

C/NC: Reported as “C” if no change or matter is observed in solution appearance and clarity. If any change or matter is observed, “NC” is reported. ND: Not Detected, NR: Not Reported

\*This osmolality data seems aberrant as it was not found back in filtration studies done afterwards. This was an isolated phenomenon to watch.

### 3.3.2.2 X - 10 MG/ML FORCED DEGRADATION RESULTS

Results of the autoclave study on a solution of X at a concentration of 10 mg/mL, are detailed in Table XII.

## Studies at laboratory scale

X solution, concentration 10 mg/mL, appearance:

- As for the solution at 2 mg/mL, data after autoclave stress were not collected but T0 were clear and colorless.

Table XII: Forced degradations results for X 10 mg/mL

Analytical tests	Specifications	RRT	X - 10 mg/mL					
			pH 4.0			pH 5.0		
			T 0	1C	2C	T 0	1C	2C
Appearance	Clear and colorless	-	C	NR	NR	C	NR	NR
Visual inspection	0 visible particles	-	C	C	C	C	C	C
pH	USP range (2.5 ≤ pH ≤ 6.5)	-	4.04	4.07	4.08	5.13	5.19	5.21
PO <sub>2</sub> (mmHg)	For information	-	18	16	16	23	17	16
Osmolality (mOsm)	For information	-	310			294		
X assay by UPLC (mg/mL)	9.00 - 11.00 mg/mL	-	10.07	10.07	10.08*	10.07	10.10	10.02
X assay by UPLC (%)	90 % - 110 %	-	100.7	100.7	96.2	100.7	101.0	100.2
Total of impurities by UPLC (%)	NMT 1.0 %	-	<b>0.20</b>	<b>0.22</b>	<b>0.24</b>	<b>0.29</b>	<b>0.26</b>	<b>0.23</b>
Impurity A	NMT 0.2 %	1.42	0.05	0.05	0.06	0.05	0.05	0.05
Impurity B	NMT 0.2 %	1.28	0.02	0.02	0.02	0.02	0.02	0.02
impurity C	NMT 0.2 %	-	ND	ND	ND	ND	ND	ND
Impurity D	NMT 0.2 %	0.36	0.04	0.04	0.05	0.04	0.05	0.04
Impurity E	NMT 0.2 %	-	ND	ND	ND	ND	ND	ND
Impurity F	NMT 0.2 %	1.078	0.08	0.10	0.10	0.16	0.12	0.10
Impurity G	NMT 0.2 %	-	ND	ND	ND	ND	ND	ND
Impurity H	NMT 0.2 %	-	ND	ND	ND	ND	ND	ND
Unknown	NMT 0.2 %	1.50	0.02	0.02	0.02	0.02	0.03	0.02

C/NC: Reported as “C” if no change or matter is observed in solution appearance and clarity. If any change or matter is observed, “NC” is reported. ND: not detected, NR: not reported

\*For this data, one result (9.156) out of two was a clear outlier and was therefore not taken into account.

## Studies at laboratory scale



### X - 10 MG/ML AND 2 MG/ML SAMPLES PH TRENDS

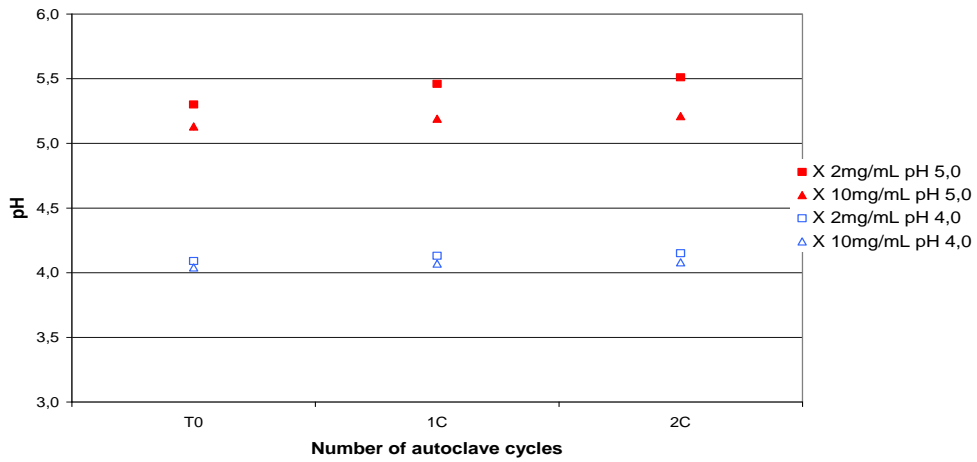

Figure 20: X 2 and 10 mg/mL, pH trend

Solutions adjusted at pH 4.0 and 5.0 remained stable and within specifications in both formulation conditions after 1 and 2 autoclave cycles. The solution at pH 5.0 presents a slight pH increase which is not significant.



### X - 10 MG/ML SAMPLES API ASSAY TRENDS, ANALYZED BY UPLC

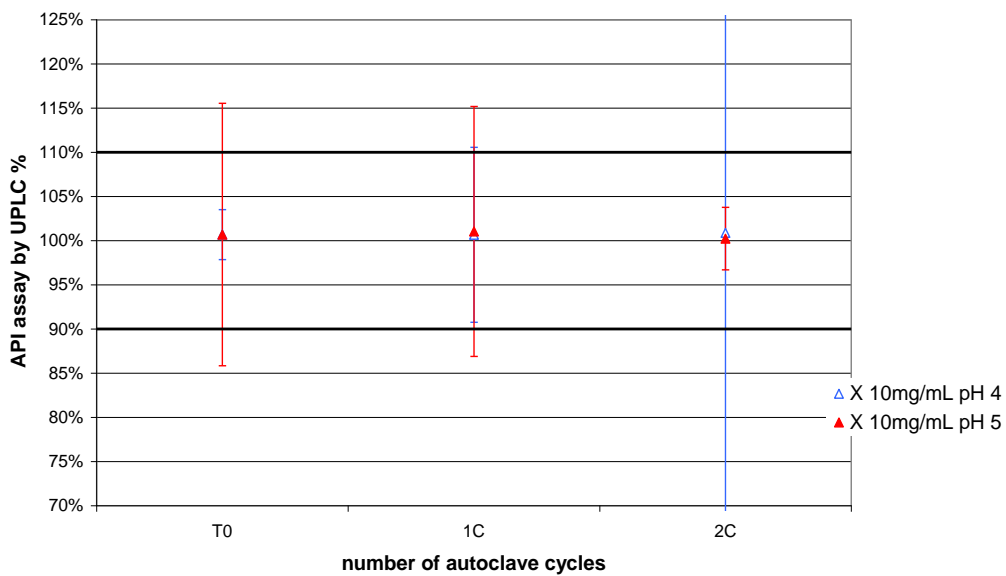

Figure 21: X 10 mg/mL API assay trend by UPLC

## Studies at laboratory scale

No significant change in the UPLC API assay can be observed. All data were within specifications and very stable even after 2 autoclave cycles.

It can be noted that the first of the two UPLC preparations for the solution of X at 10 mg/mL pH 4.0 gave a clear outlier value and decreased the overall assay content for the second autoclave cycle result. This outlier value was not considered on Figure 21.

### ➤ *X - 2 MG/ML SAMPLES API ASSAY TRENDS, ANALYZED BY UPLC*

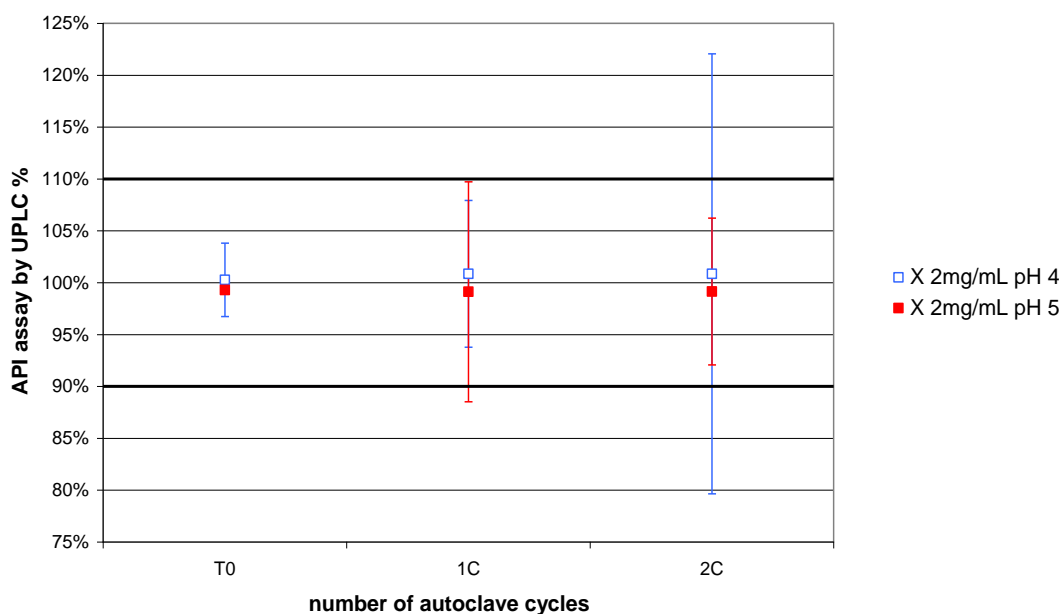

Figure 22: X 2 mg/mL API assay trend by UPLC

In the same way as results for the solution of X at a concentration of 10 mg/mL no significant change can be noticed in the UPLC API assay. Data remained stable.



## Studies at laboratory scale



### *X - 10 MG/ML SAMPLES TOTAL IMPURITIES ASSAY TRENDS, ANALYZED BY UPLC*

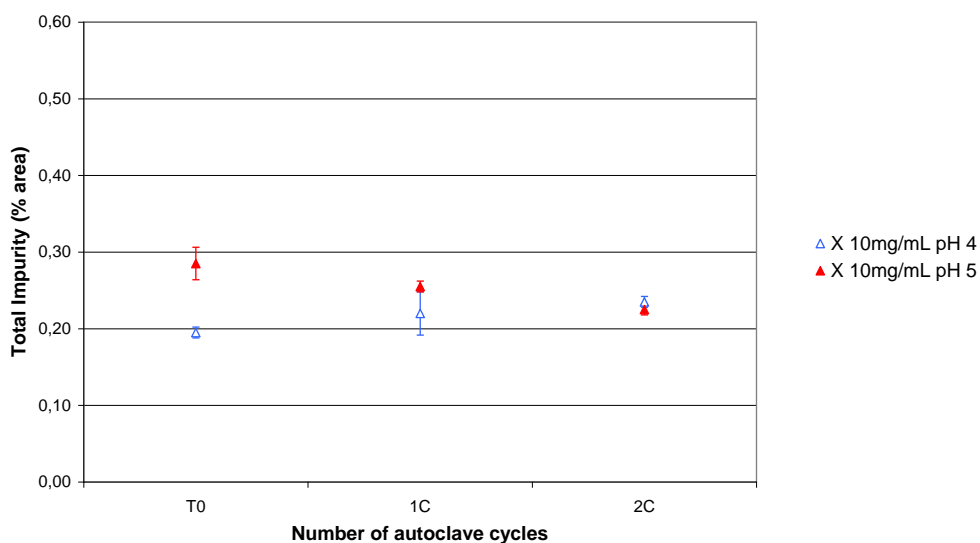

Figure 23: Total impurities trends for X 10 mg/mL by UPLC



### *X - 2 MG/ML TOTAL IMPURITIES ASSAY TREND, ANALYZED BY UPLC*

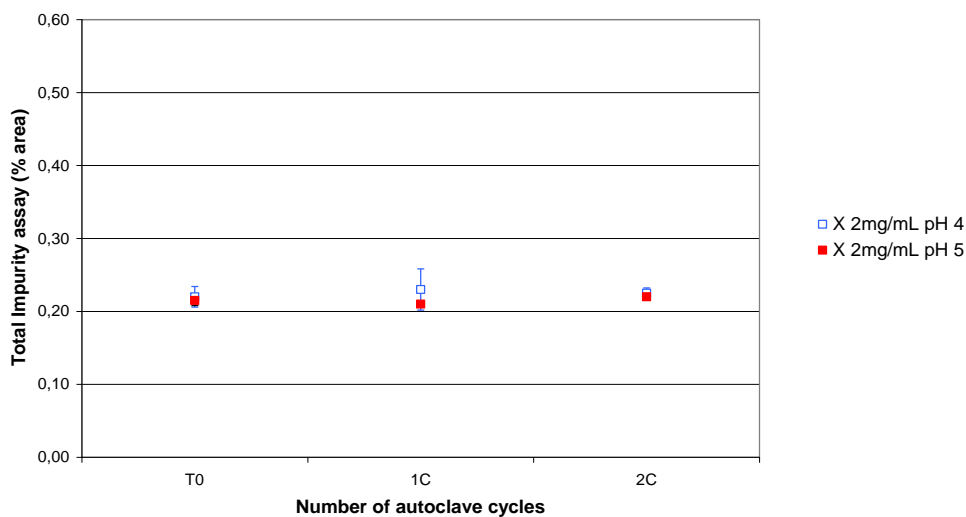

Figure 24: Total impurities trends for X 2 mg/mL by UPLC

The amount of impurities, for the solution of X at 2 mg/mL as at 10 mg/mL, was very stable after 1 or 2 autoclave cycles. The impurity content variation observed at T0 for the

## Studies at laboratory scale

solution of X at 10 mg/mL was not significant as it ranges between 0.21 % (minimum) and 0.29 % (maximum).

### 3.3.2.3 DISCUSSION ON API AND IMPURITIES ASSAYS

The API assay was not affected by the number of autoclave cycles, it stays stable and within specification.

The behavior of the two major degradation impurities has been considered. This is a way to analyze if oxidation, the first degradation pathway of X, or degradation by heat may occur when the formulation undergoes autoclave.

**Impurity B:** dimerisation product of X (first degradation scorer)

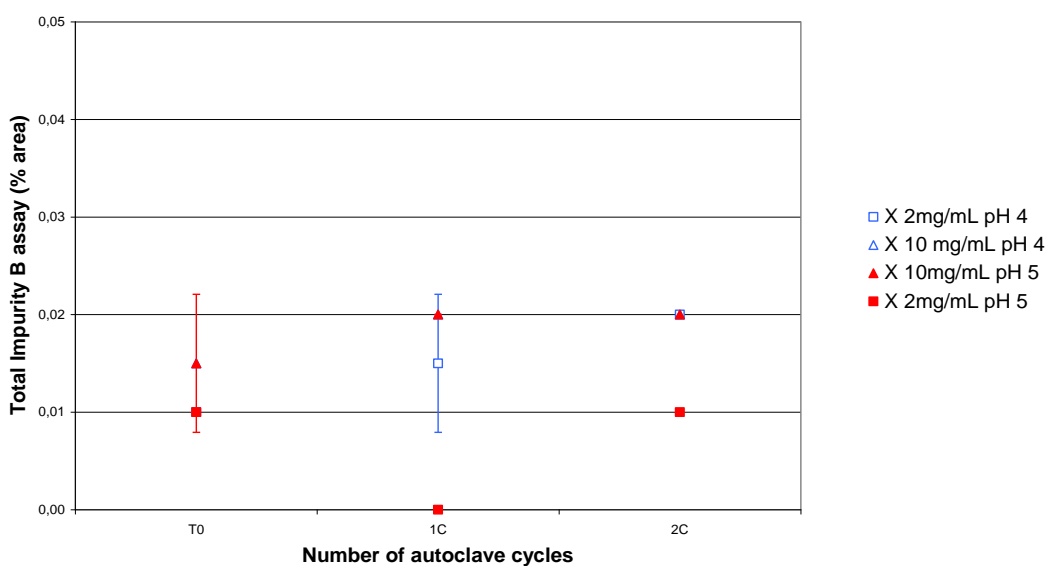

Figure 25: Impurity B UPLC assay function of autoclave cycles

The impurity B content remains stable and almost not detected at the different analyzed points.

## Studies at laboratory scale

### **Impurity F:** X-N-oxide

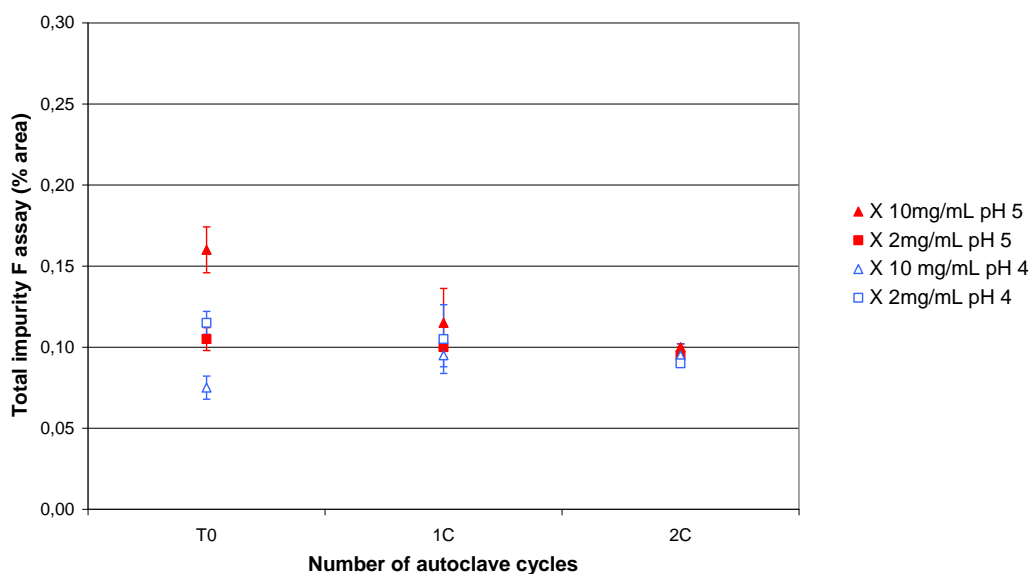

Figure 26: Impurity F UPLC assay function of autoclave cycles

The individual impurity F content decreases slightly with the number of autoclave cycles for samples 2 mg/mL at pH 4.0 and 10 mg/mL at pH 5.0. It may have been degraded into other impurities after autoclave (not visible using the current UPLC method with UV detection).

In addition, it seems that the impurity F peak is not well dissociated from the peak of X in the UPLC graph. Values listed below may then be overestimated. The analytical method has been optimized at that time.

None of the condition promoted the appearance of the impurity E which has been detected and had an interesting behavior in previous forced degradations at 80°C and 40°C/75 % RH.

During this study, the impurity A is detected at very low values. Its content is unaffected by the number of autoclave cycles. Impurity A has not been observed or in really low concentrations in forced degradations at 80°C and 40°C/75 % RH.

## Studies at laboratory scale

To summarize results obtained for this study:

- All the pH values remained stable and within specifications for the two concentrations formulated and in every autoclave condition.
- The API assay, stays stable and within specifications for the solution of X at both concentrations 2 mg/mL and 10 mg/mL under all stress conditions.
- Impurities amounts stays very low and far under specifications even though the solutions underwent 1 or 2 autoclave cycles.

---

### 3.3.3 CONCLUSION

Regarding formulations' pH determination between 4.0 and 5.0, it has not been possible to discriminate one or the other after this study. Indeed, both pH stay stable after autoclave stress and both assays, API and impurities, stay within specifications and mostly stable.

The choice has been then to continue studies with pH 5.0 for four reasons: first of all, during 40°C/75 % RH and 80°C forced degradations, pH 4.0 showed more impurities than pH 5.0, secondly the pH 5.0 is closer to the pH of X in solution (the adjustment will be easier during formulation), it is also closer to physiological pH and most of the RLD/generics formulations were found to be adjusted at that pH.

The results were similar between 2 mg/mL and 10 mg/mL concentrations. It can be underlined that appearance data are missing. Solutions coloration evolution will be to watch for other stress degradation studies as well as in pre-stability.

The results at 2 mg/mL showed that for the formulation chosen no other degradation products have been observed. The worst case didn't give additional stability data. Other studies will however always include this concentration to validate this result.

## Studies at laboratory scale

Concerning autoclaving, no assay concentration decreased, no impurity content increased and no significant pH variations were seen. At that stage of development, the product wasn't in its final primary packaging and the solution could undergo autoclave, when formulated under nitrogen.

It may be essential to perform a study with the solution in its final packaging. Indeed the behavior of Hypak® SCF syringes facing autoclave stress, pressure as well as high temperatures, may be decisive for the choice of the final sterilization process. Thus, a study involving formulations of X in syringes undergoing autoclave will be performed to take into account combination between the three different parameters: heat, product and packaging components integrity.

Two experiments will be set in order to complete this autoclave study. The compatibility of the solution of X with different references of rubbers will be tested in order to choose the appropriate stopper.

Secondly, the solution of X will be put in syringes and tested at three different temperatures, 40°C/75 % RH, 60°C and 80°C. This study will help to confirm or invalidate syringes stability during autoclave. The behavior of syringes will be monitored as much as the solution's. It will also allow collecting enough data to validate the global isothermal method employed for pre-formulation stress degradations and to extrapolate results at 25°C.

### 3.4 X AUTOCLAVABILITY WITH DIFFERENT STOPPERS AND TIP-CAP: RUBBER DISCRIMINATION

#### 3.4.1 MATERIAL AND METHOD

The aim of this study was to evaluate the stability of a solution of X at a concentration of 2 mg/mL autoclaved in contact with the following references of rubber: Stopper A, Stopper B and Tip-cap A. The appropriate elastomer will be chosen.

The formulation was set, thanks to the previous pre-formulation forced degradation tests, as follow: 2 mg/mL, pH 5, formulation under nitrogen. Autoclaving was preformed to compile additional data about that step of the process. The impact of autoclave on rubbers is interesting to watch separately from the solution stability study.

After formulation, the solution was filtered through a 0.22  $\mu\text{m}$  media filter.

The solution prepared was split in 15 non sterile borosilicate glass vials with chlorobutyl-isoprene Teflon-faced top and aluminum seal of 20 mL each which were prepared as follow:

Table XIII: Rubber compatibility studies samples

Formulation references	X-Stopper A	X-Stopper B	X-Tip-cap A
Rubber references	Stopper A	Stopper B	Tip-cap A
Number of vials prepared	5	5	5
Number of elastomer added per vial*	9	9	2
Volume of X injection solution per vial	10 mL	10 mL	10 mL

*\*Number of stoppers and tip-caps added per vials were calculated to have a surface contact equal to 356.08 mm<sup>2</sup>/ml of solution for stoppers and equal to 92.0 mm<sup>2</sup>/ml of solution for tip-caps. Regarding the Hypak<sup>®</sup> syringes filled with 1.2 or 2.2 ml, the surface contact of the solution with the stopper is around 49.0 mm<sup>2</sup>/mL and with the tip cap around 12.3 mm<sup>2</sup>/mL. The test is indeed performed in worse case by increasing the surface contact of the elastomer with a factor of roughly seven.*

## Studies at laboratory scale

The filling was done in an atmosbag to preserve the solution from a regain in oxygen during the process.

Vials were steam sterilized in an autoclave at 121°C for 20 minutes. They were then split in two studies: storage at 40°C/75 % RH in a climatic chamber and 80°C in an oven as explain in Table XIV.

Table XIV: Rubber compatibility study conditions of storage

	Time spent at 40°C/75% RH			Time spend at 80°C			
X with Tip-cap A							
X with Stopper A	BA*	AA*	T1M	BA	AA	T6D	T14D
X with Stopper B							

\*BA: Before Autoclave, AA: After Autoclave

Samples BA and AA were the same for the two temperatures and were useful to determine the autoclave impact on the formulation in contact with rubbers.

Sample AA was considered as T0 for the stress degradation study with storage at 80°C and 40°C/75 % RH.

### 3.4.2 RESULTS AND DISCUSSION

Results of the rubber compatibility test on a solution of X at a concentration of 2 mg/mL are detailed in Table XV.

#### X solution appearance:

- Every samples BA and AA were clear and colorless.
- Appearance at T6D (80°C) was not reported due to an omission.
- Solutions after 14 days at 80°C were slightly yellow with a deeper color for the sample with Tip-cap A.
- Solutions after 1 month at 40°C/75 % RH with Stoppers A and B were clear and colorless but the sample with Tip-cap A was slightly pale yellow.

All the solutions were free from visible particles.

Studies at laboratory scale

Table XV: Rubber compatibility forced degradation results for X 2 mg/mL injection

Analytical tests	Specifications	RRT	X solution 2 mg/ml															
			Stopper A					Stopper B					Tip cap A					
			BA	AA	80°C	T14D	40°C	T1M	BA	AA	80°C	T14D	40°C	T1M	BA	AA	80°C	T14D
Appearance	Clear and colorless	-	C	C	NR	NC	C	C	C	NR	NC	C	C	C	NR	NC	NC	NC
Visual inspection	0 visible particles	-	C	C	NR	C	C	C	C	NR	C	C	C	C	NR	C	C	C
pH	USP range (2.5 ≤ pH ≤ 6.5)	-	5.69	5.72	6.01	6.14	5.96	5.27	5.57	5.68	5.71	5.71	5.34	6.28	6.46	6.27	6.13	
PO <sub>2</sub> (mmHg)	For information	-	24	17	16	15	17	24	18	16	15	18	20	19	17	14	17	
Osmolality (mOsm)	For information	-	296					296					296					
X assay by UPLC (mg/mL and %)	1,80 - 2,20 mg/mL		2.16	1.98	2.07	2.07	2.05	2.03	2.00	2.07	2.05	2.03	2.05	2.10	2.04	2.03	2.03	
	90 % - 110 %	-	108	99	104	104	103	102	100	104	103	102	102	105	102	101	102	
Total of impurities by UPLC (%)	NMT 1.0 %	-	<b>0.24</b>	<b>0.23</b>	<b>0.30</b>	<b>0.31</b>	<b>0.32</b>	<b>0.23</b>	<b>0.23</b>	<b>0.28</b>	<b>0.32</b>	<b>0.35</b>	<b>0.22</b>	<b>0.45</b>	<b>0.96</b>	<b>1.01</b>	<b>0.68</b>	
Impurity A	NMT 0.2 %	1.28	0.05	0.05	0.05	0.06	0.06	0.05	0.05	0.04	0.06	0.08	0.04	0.04	0.14	0.25	0.08	
Impurity B	NMT 0.2 %	1.12	ND	ND	0.02	0.03	0.04	ND	ND	0.02	0.02	0.07	ND	ND	ND	ND	ND	
Impurity C	NMT 0.2 %	1.31	0.02	0.02	0.03	0.03	0.02	0.02	0.03	0.03	0.03	0.02	0.03	0.03	0.02	ND	0.03	
Impurity D	NMT 0.2 %	0.62	0.04	0.04	0.05	0.07	0.05	0.04	0.04	0.05	0.06	0.05	0.04	0.04	0.05	0.06	0.04	
Impurity E	NMT 0.2 %	-	ND	ND	ND	ND	ND	ND	ND	ND	ND	ND	ND	ND	ND	ND	ND	
Impurity F	NMT 0.2 %	1.03	0.13	0.12	0.14	0.11	0.08	0.12	0.11	0.13	0.14	0.13	0.11	0.11	0.13	0.13	0.12	
Impurity G	NMT 0.2 %	-	ND	ND	ND	ND	ND	ND	ND	ND	ND	ND	ND	ND	ND	ND	ND	
Impurity H	NMT 0.2 %	1.52	ND	ND	ND	ND	ND	ND	ND	ND	ND	ND	ND	ND	ND	ND	ND	
Unknown	NMT 0.2 %	0.27	ND	ND	0.01	0.01	ND	ND	ND	0.01	0.01	ND	ND	ND	ND	ND	ND	
Unknown	NMT 0.2 %	0.29	ND	ND	ND	ND	ND	ND	ND	ND	ND	ND	ND	0.01	0.05	0.07	ND	
Unknown	NMT 0.2 %	1.43	ND	ND	ND	ND	ND	ND	ND	ND	ND	ND	ND	ND	0.11	0.15	ND	
Unknown	NMT 0.2 %	0.35	ND	ND	ND	ND	ND	ND	ND	ND	ND	ND	ND	ND	ND	ND	0.03	
Unknown	NMT 0.2 %	1.46	ND	ND	ND	ND	ND	ND	ND	ND	ND	ND	ND	0.22	0.46	0.35	0.38	

C/NC: Reported as “C” if no change or matter is observed in solution appearance and clarity. If any change or matter is observed, “NC” is reported. ND: not detected, NR: not reported



## Studies at laboratory scale

Trends obtained for autoclave impact on the formulation in contact with stoppers will be presented first (BA and AA data). The formulation stability study after storage at 80°C and 40°C/75 % RH will be presented afterwards. Standard deviations were calculated only for pH data as other analysis were not done several times.

### 3.4.2.1 X 2 MG/ML AUTOCLAVE IMPACT TRENDS



#### *pH* TREND

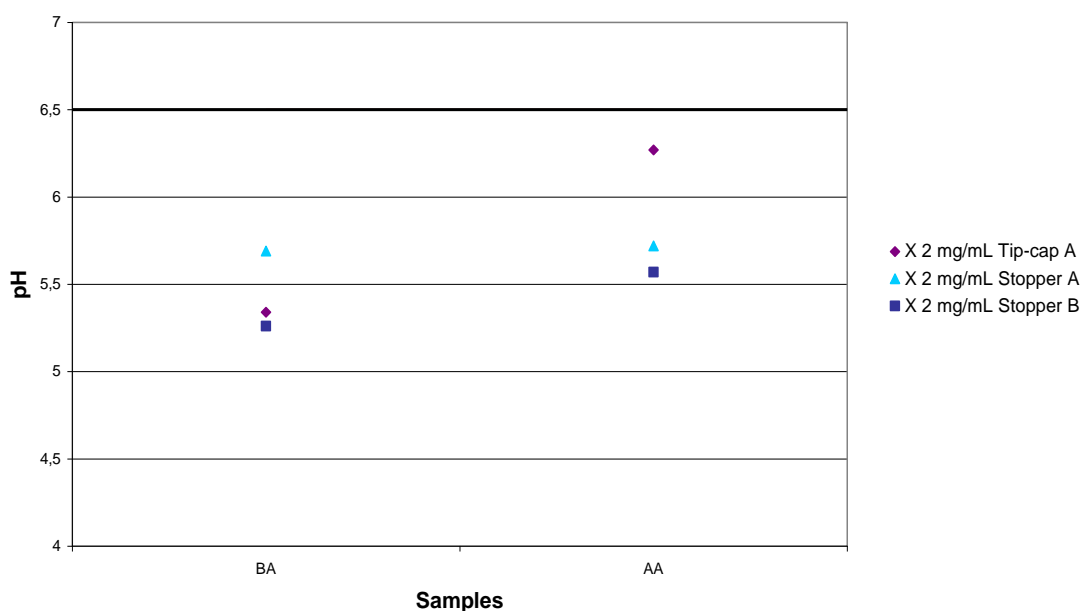

Figure 27: X 2 mg/mL, pH trend when autoclaved

All samples remained within specifications.

The sample with Tip-cap A was well impacted by autoclaving. Its pH increased of almost one unit between BA and AA.

The sample with Stopper B showed the same trend as the sample with Tip-cap A however the increase of pH was less important.

## Studies at laboratory scale

The sample with Stopper A had a pH value already high for BA, the three samples with Stopper A, Stopper B and Tip-cap A were done with the same formulation. This observation has just been done with the sample with Stopper A. This pH sample stays stable after autoclave.

### ➤ *API ASSAY TREND ANALYZED BY UPLC*

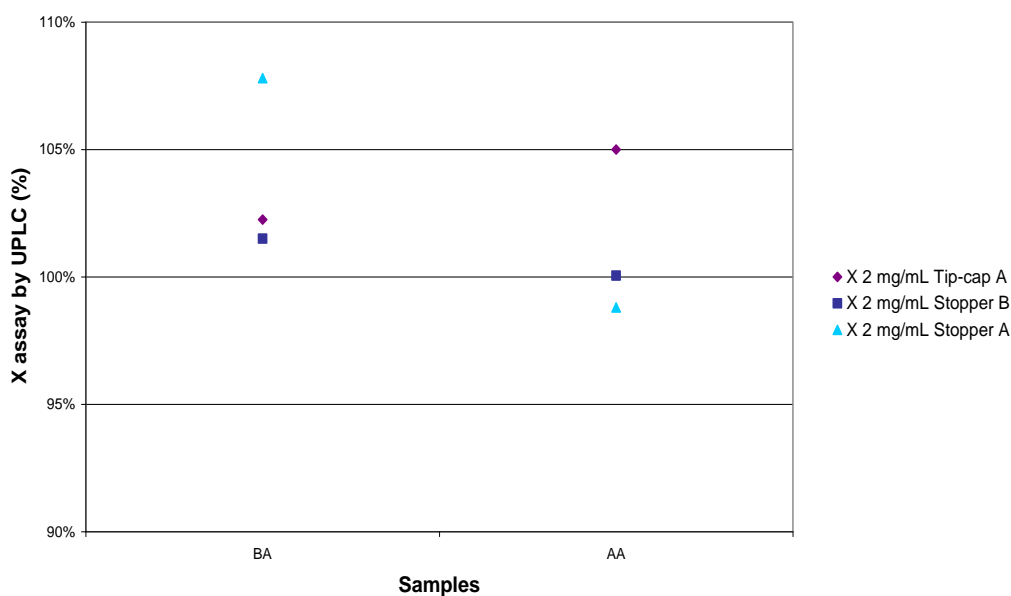

Figure 28: X 2 mg/mL API assay trend by UPLC when autoclaved

API amounts of solutions of X at a concentration of 2 mg/mL with Tip-cap A and Stopper B seemed quite stable in time and stayed within specifications.

A strong variation of API content is seen for the sample with Stopper A. Before Autoclave (BA) API amounts seemed very high, while AA value is closer to 100%. This variation may be due to analytical method variability.

## Studies at laboratory scale



### TOTAL IMPURITIES ASSAY TREND ANALYZED BY UPLC

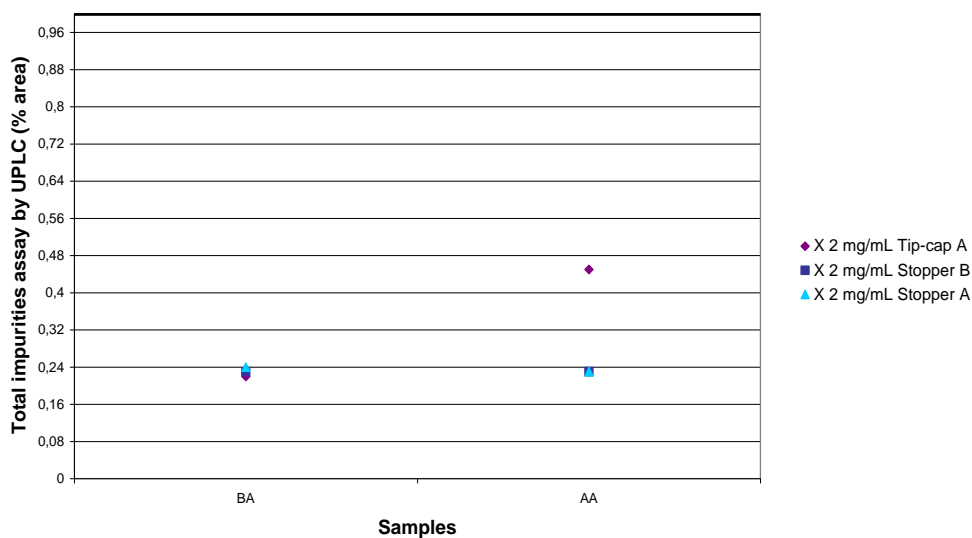

Figure 29: X 2 mg/mL total impurities assay trend by UPLC when autoclaved

The total impurity of samples “X - 2 mg/mL” with the Tip-cap showed obviously a strong increase right after autoclaving.

The amount of total impurities was lower for samples with Stoppers A and B, and seemed not impacted by the autoclave step.

#### 3.4.2.2 X 2 MG/ML 80°C AND 40°C STABILITY TRENDS

Data regarding samples stability at 40°C/75 % RH and 80°C after autoclave are presented below in the same graph to check if that trends are equivalent between the two temperatures. Sample AA is considered as T0 for this study.

## Studies at laboratory scale



### *P*H TREND

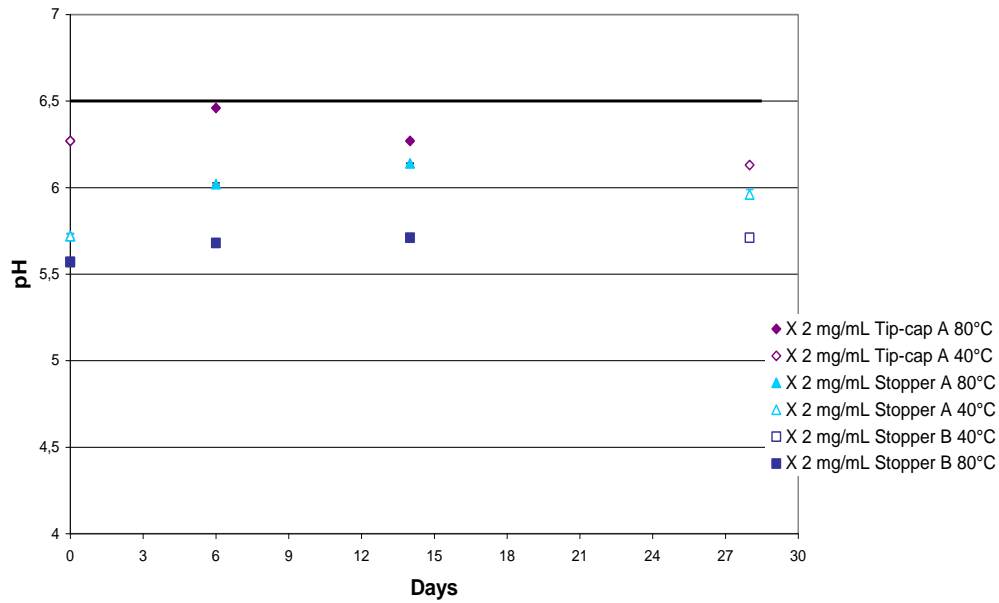

Figure 30: X 2 mg/mL, pH trends for 80 and 40°C storage

All the pHs after autoclaving were high, above 5.5, but during stability storage they seem to stay stable in time and within specifications.

The samples with Stopper A presented the biggest increase when stored at 80°C and 40°C/ 75 % RH but stays in specifications for both conditions.

Data at 40°C/75 % RH had the same trend as 80°C.

## Studies at laboratory scale



### API ASSAY TREND ANALYZED BY UPLC

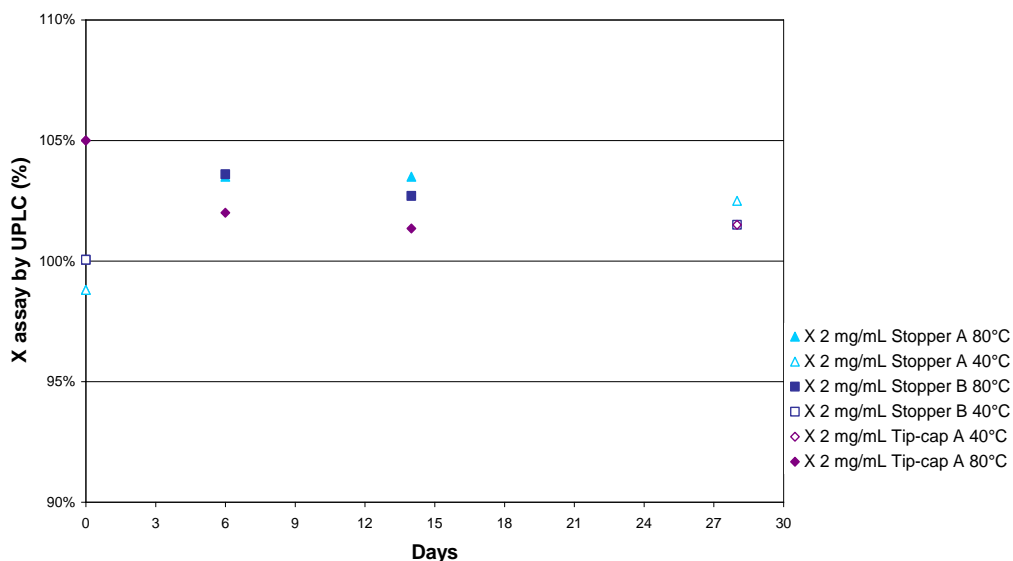

Figure 31: X 2 mg/mL API assay trend by UPLC for 80 and 40°C storage

The API amounts for 80°C trends were in specifications but an increase is seen between T0 and T6D for samples with Stopper B and A. The opposite trend was observed for samples with Tip-cap A. Data seemed to stabilize after T6D for all samples at 80°C.

Trends at 40°C/ 75 % RH condition add up data at 80°C, the point T1 month at 40°C was practically equivalent to the point T6D at 80°C.

## Studies at laboratory scale



### TOTAL IMPURITIES ASSAY TREND ANALYZED BY UPLC

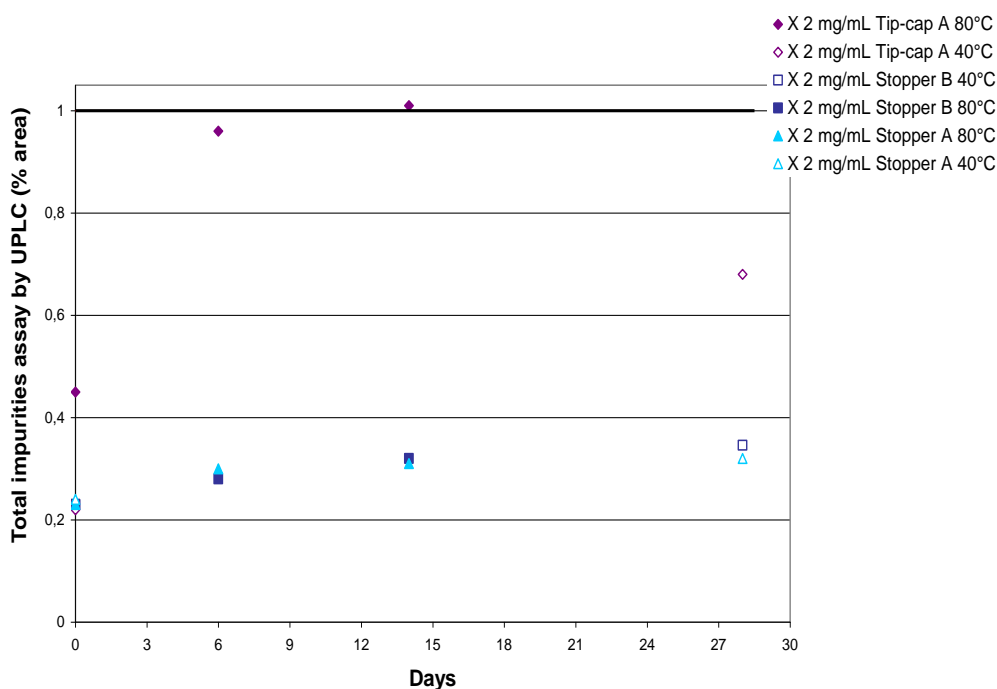

Figure 32: X 2 mg/mL total impurities assay trend by UPLC at 40°C

Results at 40°C/75 % RH add up data at 80°C. The same important increase of impurity is seen for samples with Tip-cap A, passing over specification limit when stored six days at 80°C.

Other samples showed also an increase of the total impurity content but the amount stayed lower than the sample with Tip-cap A amount and far under specifications.

Samples with Stopper A showed an increase slightly smaller than other samples when stored at 40°C/75 % RH during 1 month. The discrimination with Stopper B when samples are stored at 80°C was less visible.

#### 3.4.2.3 DISCUSSION AND INTERPRETATION

This study was set to evaluate the stability of “X - 2 mg/mL” solution in contact with different references of rubber compatible with the Hypak® SCF syringe.

## Studies at laboratory scale

### Autoclaving impact:

- Regarding the pH behavior, the Tip-cap A samples undergo a significant increase of pH, the pH of the Stopper B samples seems also unstable with an increase of 0.3 unit of pH. The pH of Stopper A samples stays stable but the pH before autoclave was already high.
- Regarding total impurities amount, values for the Tip-cap A samples showed an increase when autoclaved whereas other samples remain stable. Every sample stayed under specifications.
- Regarding the API assay, the Tip-cap A and the Stopper B samples seemed stable but the Stopper A sample presented a high BA value. It may be an outlier point. Point AA was close to 100 % which may be more relevant.

### Stability study at 80°C and 40°C/75 % RH:

Data collected for the condition at 80°C add up data for the condition 40°C/75 % RH. Results presented the same tendency and could be extrapolated. Indeed T6D at 80°C seems equivalent to T1M at 40°C/75 % RH.

- Regarding the pH behavior: the Stopper A samples presented more variations with a slight increase of less than 0.5 pH units. The pH of other samples stayed more stable in time whatever the conditions.
- Regarding the API assay: The Tip-cap A samples decrease may be due to a high degradation of X in accordance with the total impurities assay graphic. The API amount of other samples stay quite stable and in specifications.
- Regarding the total impurities amount: the sample with Tip-cap A showed a dramatic increase of total impurities for both conditions. Impurities created may not be due to oxidation (impurity B was almost not detected and impurity F was stable whatever conditions and rubber). An unknown impurity with RRT at 1.46 was the more important contributor to the high total impurity during the study at 80°C as well as 40°C/75 % RH. It was detected right after autoclave and during all

## Studies at laboratory scale

the storage, from 0.22 % for sample AA to 0.46 % at T6D (80°C) and 0.35 % at T14D (80°C). At 40°C/75 % RH its amount was equal to 0.38 % after 1 month of storage. Impurity A was also created during storage (40°C: 0.08 %, 80°C: 0.14 % for T6D and 0.25 % for T14D). Two others unknown impurities were detected at 80°C, with amounts less important than RRT = 1.46. The main one had an RRT = 1.43, its content increased from 0.11 % at T6D to 0.15 % at T14D. The second one had an RRT = 0.29 and increased from 0.01 % for AA to 0.05 % for T6D and 0.07 % for T14D. At 40°C/75 % RH those two unknown impurities were not identified.

### 3.4.3 CONCLUSION

The compatibility study has been performed under stress conditions:

- The ratio of rubber contact surface/volume of solution have been increased by a factor of seven compared to X injection solution filled in 1.25 mL Hypak® SCF.
- Solutions have been steam-sterilized at 121°C for 20 minutes in order to mimic the normal process undergone by solutions filled in syringes.

Regarding the study results, the samples with Tip-cap A showed the most important impurity amount, API degradation and pH variation but values stayed in specifications.

Indeed, impurities amounts stayed in specifications for both studies. The only point crossing is T14D at 80°C. This condition is very strong to stress an API, the trend observed during the study at 80°C seemed to stabilize after that value. The Tip-cap A can then be used but those stability data have to be taken into account and a watch will be implemented in further pre-stability studies.

No significant differences are observed between samples with Stopper B and samples with Stopper A: The API assay showed the same tendency, the total amount of impurities increased slightly but in the same proportion and less than in the sample with Tip-cap A.



### Studies at laboratory scale

Samples with the Stopper A presented the highest pH increase when stored at 80°C and 40°C/75 % RH and showed a non explicated high value for the point BA. Globally there pH values are in specifications and not discriminative. However, given the fact that pH values seems less stable for samples with Stopper A and that, from experience, the stopper B stands better for autoclaving, we suggested to use the stopper B to continue the studies on the solution of X.

In order to better evaluate the compatibility of a solution of X with rubber references when the formulation is filled in its final packaging and as no process is already defined, a pre-stability study is to be launched using ICH accelerated conditions for six months and long-term stability conditions for twelve months.

A pre-development stress degradation study with syringes undergoing autoclave was also performed to take into account combination between the three different parameters: heat, solution, rubber. This study will permit to determine if the non-isothermal method used for pre-development forced degradation studies can give representative and workable results to extrapolate the solution stability at 25°C. This study, as previously discussed in section 3.3.3 is described right after.

### **3.5 X PRE-STABILITY AND AUTOCLAVABILITY STUDY AT 40°C/75 % RH, 60°C AND 80°C**

#### **3.5.1 MATERIAL AND METHOD**

The goal of this study is to evaluate the effect of steam sterilization on a solution of X at 2 mg/mL adjusted at pH 5.0. The solution was filled in Hypack® SCF syringes using Stopper B and Tip-cap A, with a compounding and filling under a high level of nitrogen. It was then put in stability in two different conditions: 40°C/75 % RH and 80°C. This study will allow determining if syringes can undergo autoclave.

Another objective for the study is to evaluate the correlation between stability data generated for a same formulation at different temperatures. One formulation inerted and autoclaved was placed at 60°C on top of the ones at 40°C/75 % RH, and 80°C and data generated at the three different temperatures compared.

The study at 40°C/75 % RH involved two formulations: X at concentration 2 mg/mL, inerted and autoclaved and X at concentration 2 mg/mL, inerted and non autoclaved. The only condition including X at a concentration of 2 mg/mL, at pH 5.0, inerted and autoclaved was 60°C. Formulations were named “X 2-N2-A” and “X 2-N2-NonA” to make it easier.

Steam sterilization was carried out on syringes at 121°C for twenty minutes, with the PdC manufacturing plant autoclave.

Syringes were placed horizontally on rondo trays after steam sterilization and rondos were placed in cardboard boxes. Each cardboard box is filled with nine syringes to perform analysis. For each condition, the oxygen partial pressure is measured on three syringes; the three syringes are then pooled to perform pH measurement and osmolality when required. Six other syringes are needed for the UPLC analysis.

To accommodate the large number of samples, cardboard boxes were filled with nine syringes each and placed under the following storage conditions:

## Studies at laboratory scale

Table XVI: Pre-stability and autoclavability samples at 40°C/75 % RH, 80°C and 60°C conditions

	Time spend at 40°C/75% RH				Time spend at 80°C				Time spend at 60°C			
	T0	T1M*	T2M	T3M	T0	T2D*	T6D	T14D	T0	T6D	T14D	T28D
X 2 –N2-A												
X 2-N2-Non A												

\*M: Month; D: Day

As pH is fixed at 5.0, the criterion of acceptance was then  $4.5 \leq \text{pH} \leq 5.5$ .

### 3.5.2 RESULTS AND DISCUSSION

Firstly, results obtained for the study at 80°C are presented then the results for the study at 40°C/75 % RH. Data obtained at 60°C will be developed afterwards. All trends are presented with standard deviations.

Discussion and conclusion about the autoclave process will be treated right after 80°C and 40°C/75 % RH results. The 60°C data will permit to correlate pre-development forced degradation results and to extrapolate at 25°C.

#### 3.5.2.1 80°C STABILITY RESULTS

Autoclavability and stability test results at 80°C on a solution of X at a concentration of 2 mg/mL are detailed in Table XVII.

X solution appearance:

- Every T0 and T2D syringes were clear and colorless,
- The T6D samples were slightly yellow, non autoclaved samples presented a deeper color than autoclaved samples,

Studies at laboratory scale

- Both samples at T14D were identically pale yellow.

Generally speaking, all samples were free from particles. It is to note that for the T14D time point, syringes stoppers had moved back up to the syringe label (syringes autoclaved less than syringes non autoclaved).

Table XVII: X 2 mg/mL, inerted, autoclaved and non autoclaved injection stability results at 80°C

Analytical tests	Specifications	RRT	X 2-N2-A				X 2 N2-non A			
			T0	T2D	T6D	T14D	T0	T2D	T6D	T14D
Appearance	Clear and colorless	-	C	C	NC	NC	C	C	NC	NC
Visual inspection	0 visible particles	-	C	C	C	C	C	C	C	C
pH	USP range (4.5 ≤ pH ≤ 5.5)	-	5.6	5.3	4.8	4.5	5.5	5.2	4.8	4.6
Osmolality (mOsm)	For information	-	289				289			
PO <sub>2</sub>	For information	-	49	42.7	40.7	43	52	44	45.3	44
X assay by UPLC (%)	90 % - 110 %	-	101.47	101.48	101.40	99.81	101.18	101.18	101.79	101.78
Total of impurities by UPLC (%)	NMT 1.0 %	-	<b>0.17</b>	<b>0.34</b>	<b>0.510</b>	<b>0.89</b>	<b>0.16</b>	<b>0.37</b>	<b>0.65</b>	<b>0.83</b>
Impurity A	NMT 0.2 %	1,4	0,04	0,04	0,04	0,04	0,04	0,04	0,04	0,04
Impurity B	NMT 0.2 %	1,27	0,03	0,1	0,2	0,24	0,04	0,15	0,28	0,3
Impurity C	NMT 0.2 %	1,49	0,02	0,04	0,06	0,08	0,02	0,05	0,09	0,08
Impurity D	NMT 0.2 %	0,35	0,03	0,04	0,04	0,04	0,03	0,04	0,04	0,04
Impurity E	NMT 0.2 %	1,21	ND	ND	ND	ND	ND	ND	ND	ND
Impurity F	NMT 0.2 %	1,07	0,04	0,04	0,05	0,05	0,04	0,04	0,04	0,05
Impurity G	NMT 0.2 %	0,73	ND	0,04	0,05	0,15	ND	0,03	0,07	0,12
Impurity H	NMT 0.2 %	1,9	ND	ND	ND	ND	ND	ND	ND	ND
Impurity of impurity G	NMT 0.2 %	-	ND	ND	ND	ND	ND	ND	ND	ND
Unknown	NMT 0.2 %	0,16	ND	0,01	0,02	0,14	ND	0,01	0,02	0,06
Unknown	NMT 0.2 %	0,31	ND	ND	0,01	0,03	ND	ND	0,01	0,02
Unknown	NMT 0.2 %	1,11	ND	0,01	0,02	0,06	ND	ND	0,01	0,02
Unknown	NMT 0.2 %	1,13	ND	0,01	0,01	0,03	ND	0,01	0,04	0,07
Unknown	NMT 0.2 %	1,27	ND	ND	ND	0,01	ND	0,01	0,02	0,02
Unknown	NMT 0.2 %	1,6	ND	ND	ND	0,02	ND	ND	ND	0,01

C/NC: Reported as “C” if no change or matter is observed in solution appearance and clarity. If any change or matter is observed, “NC” is reported. ND: not detected, NR: not reported.

## Studies at laboratory scale



### ***P**H TREND*

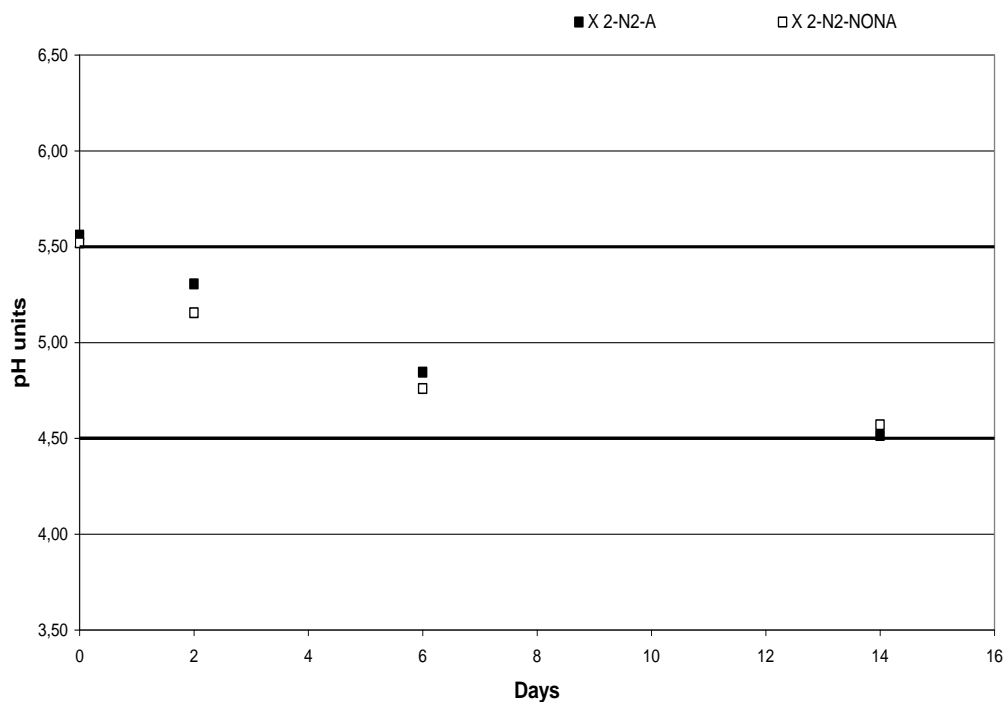

Figure 33: X 2 mg/mL, inerted, autoclaved and non autoclaved pH trend at 80°C

Both formulations' pH showed a clear decrease but stayed in specifications over time except X 2-N2-A at T0 which pH is equal to 5.6. Both formulations values stayed very close to each other.

## Studies at laboratory scale



### OXYGEN PARTIAL PRESSURE TREND

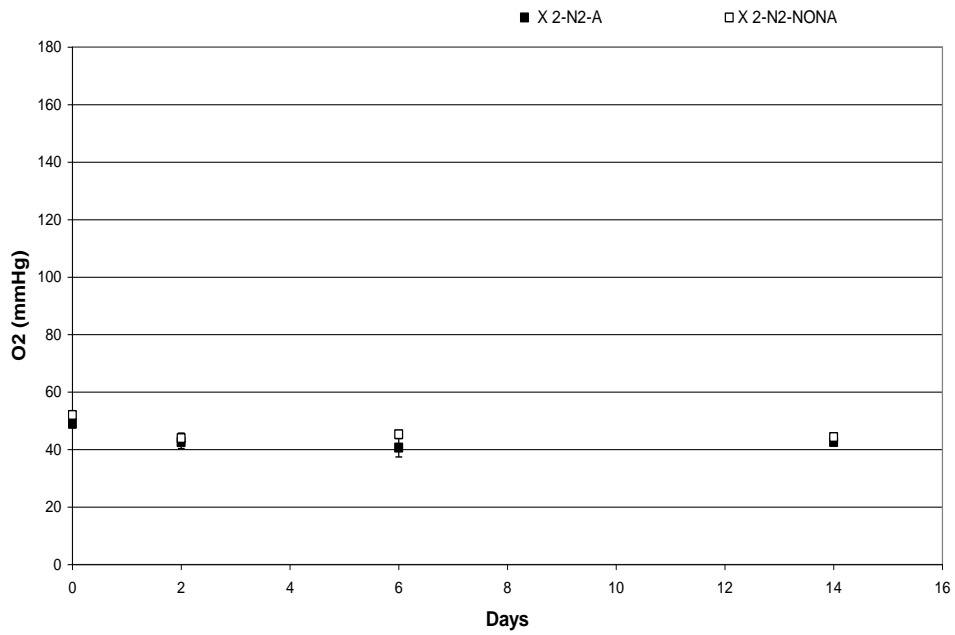

Figure 34: X 2 mg/mL, inerted, autoclaved and non autoclaved PO<sub>2</sub> trend at 80°C

The oxygen partial pressure remained very stable over time. Syringes were hermetic. Values stayed under 80 mmHg indicating that nitrogen was still protective.



### API ASSAY TREND ANALYZED BY UPLC

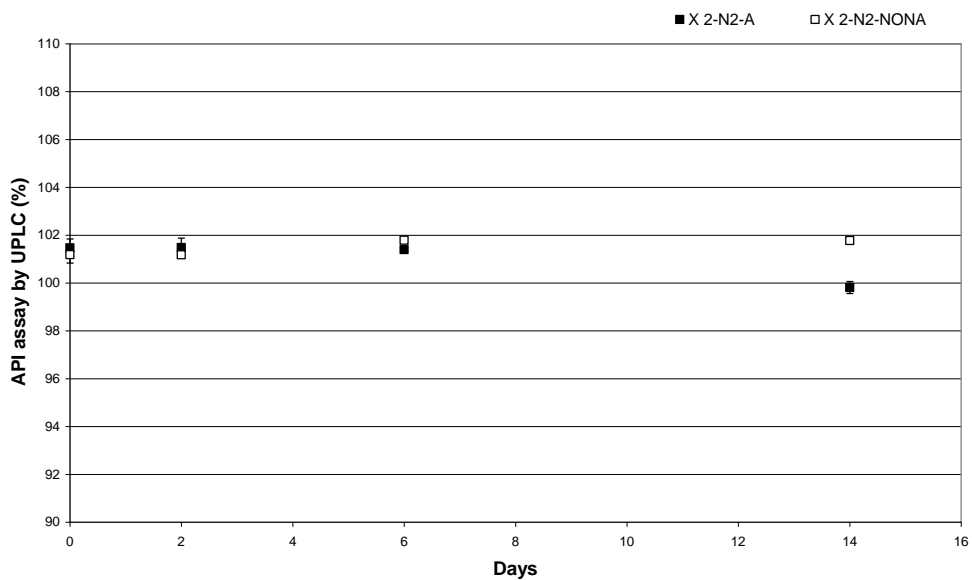

Figure 35: X 2 mg/mL, inerted, autoclaved and non autoclaved API assay trend at 80°C

## Studies at laboratory scale

The API amounts for both formulations remained stable over time and in specifications.



### TOTAL IMPURITIES ASSAY TREND ANALYZED BY UPLC

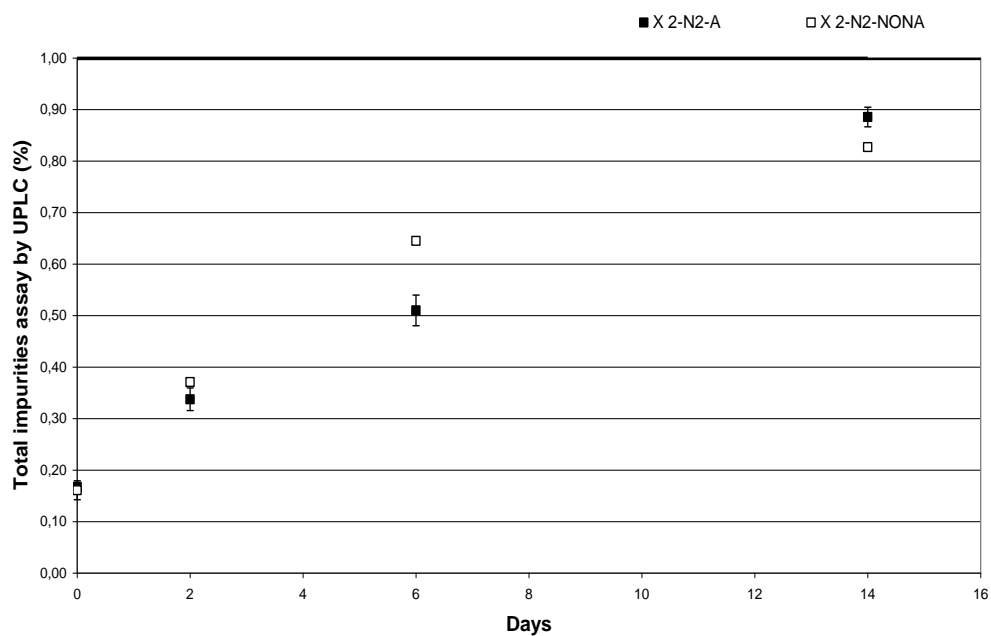

Figure 36: X 2 mg/mL, inerted, autoclaved and non autoclaved total impurities assay trend at 80°C

The total impurities amount showed an increase when syringes were stored up to 14 days at 80°C. The impurities content for the formulation autoclaved seemed less impacted.

As usual, impurities behaviors were studied separately. Three impurities were interesting to be analyzed during this study: impurity B, impurity F and the unknown impurity with RRT equal to 0.16.

## Studies at laboratory scale



### IMPURITY B ASSAY TREND ANALYZED BY UPLC

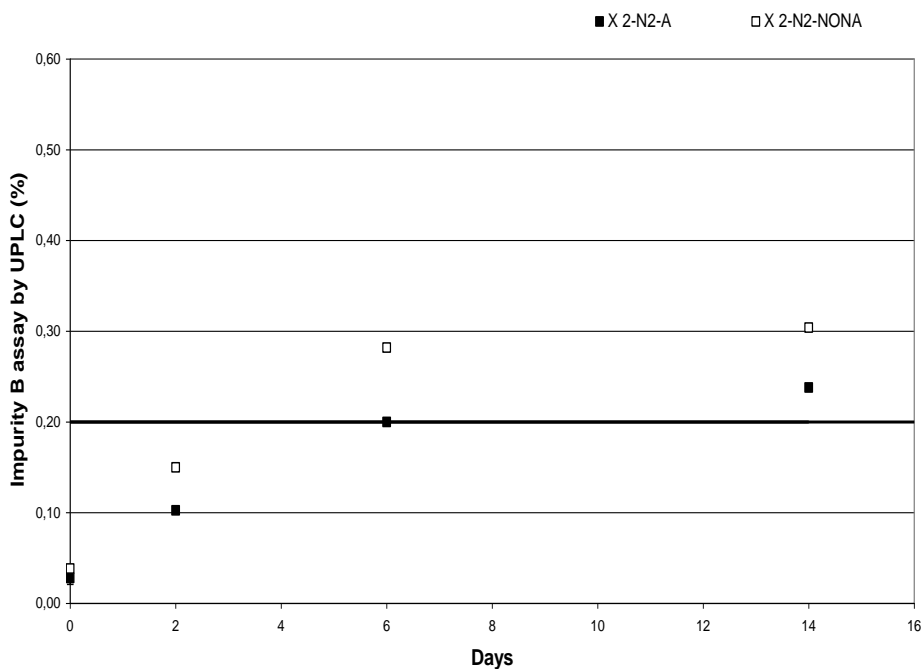

Figure 37: X 2 mg/mL, inerted, autoclaved and non autoclaved impurity B assay trend at 80°C

Impurity B was the main contributor to the high total impurities. It is the first scorer of the degradation of X. This impurity seemed inhibited when the formulation was autoclaved. The impurity B amount for the formulation “X 2-N2-A” was about ten percents smaller than the formulation “X 2-N2-Non A” for all samples except T0. After a sharp increase between T0 and T6D, the impurity B creation seemed to stabilize at T14D.



## Studies at laboratory scale



### IMPURITY F ASSAY TREND ANALYZED BY UPLC

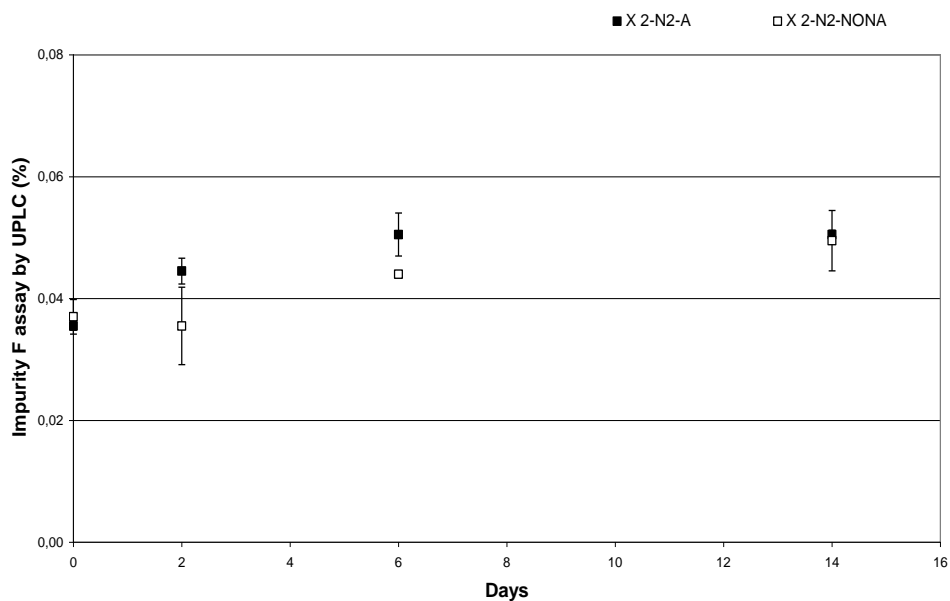

Figure 38: X 2 mg/mL, inerted, autoclaved and non autoclaved impurity F assay trend at 80°C

Impurity F amount was also interesting to watch as it is the second oxidation degradation product of X. For both formulations, amounts were close (the formulation X 2-N2-NonA at time point T2D had the greatest standard deviation); no clear increase was observed and the results were low for both formulations.

## Studies at laboratory scale



### IMPURITY WITH RRT= 0.16 ASSAY TREND ANALYZED BY UPLC

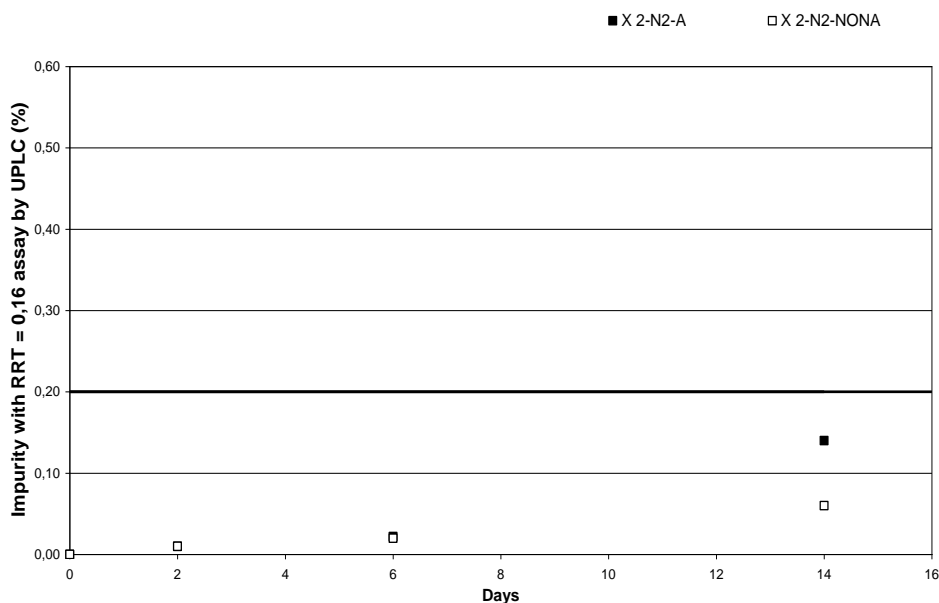

Figure 39: X 2 mg/mL, inerted, autoclaved and non autoclaved impurity with RRT = 0.16 assay trend at 80°C

This impurity was more promoted than impurity F and well contributed to the total impurities increase. After 14 days at 80°C its amount was equal to 0.14 % for the formulation “X 2-N2-A” and 0.06 % for the formulation “X 2 N2-NonA” whereas it wasn’t detected at T0. This impurity being higher in the autoclaved formulation and obviously increasing over time, it seems to be promoted by heat.

Its appearance is to be watched during others studies at the two temperature conditions 40°C/75 % RH and 60°C.

#### 3.5.2.2 40°C/75 % RH STABILITY RESULTS

Autoclavability and stability tests results at 40°C/75 % RH on a solution of X at 2 mg/mL are exposed in Table XVIII.

## Studies at laboratory scale

### X solution appearance:

- Every T0, T1M and T2M syringes were clear, colorless and free from particles.
- Appearance was not reported for T3M due to omission.

Table XVIII: X 2 mg/mL, inerted, autoclaved and non autoclaved injection stability results at 40°C/75 % RH

Analytical tests	Specifications	RRT	X 2-N2-A				X 2 N2-non A			
			T0	T1M	T2M	T3M	T0	T1M	T2M	T3M
Appearance	Clear and colorless	-	C	C	C	NR	C	C	C	NR
Visual inspection	0 visible particles	-	C	C	C	NR	C	C	C	NR
pH	USP range (4.5 ≤ pH ≤ 5.5)	-	5,7	5,4	5,5	5,3	5,3	5,4	5,2	5,2
Osmolality (mOsm)	For information	-	289				289			
PO <sub>2</sub>	For information	-	27,3	52,7	69,7	92,3	29,7	59	78	96,7
X assay by UPLC (%)	90 % - 110 %	-	102,25	101,3	101,08	101,1	100,56	101	101,07	100,99
Total of impurities by UPLC (%)	NMT 1.0 %	-	<b>0,19</b>	<b>0,23</b>	<b>0,41</b>	<b>0,68</b>	<b>0,18</b>	<b>0,3</b>	<b>0,51</b>	<b>0,74</b>
Impurity A	NMT 0.2 %	1,4	0,05	0,04	0,03	0,05	0,05	0,04	0,03	0,03
Impurity B	NMT 0.2 %	1,27	0,02	0,11	0,14	0,25	0,01	0,21	0,27	0,38
Impurity C	NMT 0.2 %	1,49	0,03	0,02	0,02	0,03	0,02	0,03	0,03	0,04
Impurity D	NMT 0.2 %	0,35	0,04	0,02	0,03	0,03	0,03	ND	0,04	0,04
Impurity E	NMT 0.2 %	1,21	0,02	ND	ND	0,05	0,03	ND	ND	0,07
Impurity F	NMT 0.2 %	1,07	0,03	0,03	0,03	0,08	0,04	0,04	0,04	0,08
Impurity G	NMT 0.2 %	0,73	ND	ND	0,07	0,08	ND	ND	0,05	0,05
Impurity H	NMT 0.2 %	1,9	ND	ND	ND	ND	ND	ND	ND	ND
Impurity of impurity G	NMT 0.2 %	-	ND	ND	ND	ND	ND	ND	ND	ND
Unknown	NMT 0.2 %	0,16	0,01	0,01	0,06	0,08	ND	ND	0,03	0,02
Unknown	NMT 0.2 %	0,42	0,01	ND	ND	ND	ND	ND	ND	ND
Unknown	NMT 0.2 %	1,11	0,01	ND	0,02	0,03	ND	ND	0,03	0,02
Unknown	NMT 0.2 %	1,12	0,01	ND	ND	ND	ND	ND	ND	ND
Unknown	NMT 0.2 %	1,14	ND	ND	ND	ND	ND	ND	0,01	ND
Unknown	NMT 0.2 %	1,2	ND	ND	ND	0,02	ND	ND	ND	ND
Unknown	NMT 0.2 %	1,26	0,01	ND	0,02	0,03	ND	ND	ND	0,01

C/NC: Reported as “C” if no change or matter is observed in solution appearance and clarity. If any change or matter is observed, “NC” is reported. ND: not detected, NR: not reported.

## Studies at laboratory scale



### PH TREND

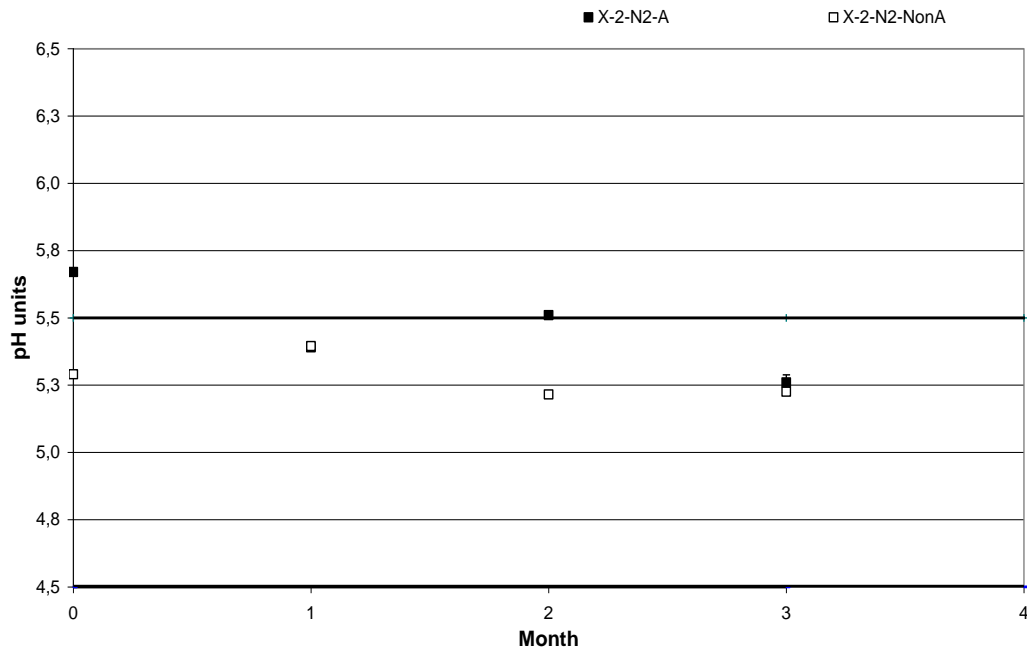

Figure 40: X 2 mg/mL, inerted, autoclaved and non autoclaved pH trend at 40°C/75 % RH

During this study, it can be observed decreasing pH values for both formulations. However, pH of the formulation “X 2-N2-NonA” stayed in specifications and practically stable over time. pH at T0 for the formulation “X 2 N2-A” is 0.2 pH units higher than the upper specification. Values stayed practically stable afterwards (5.4 / 5.5 / 5.3).

## Studies at laboratory scale



### OXYGEN PARTIAL PRESSURE TREND

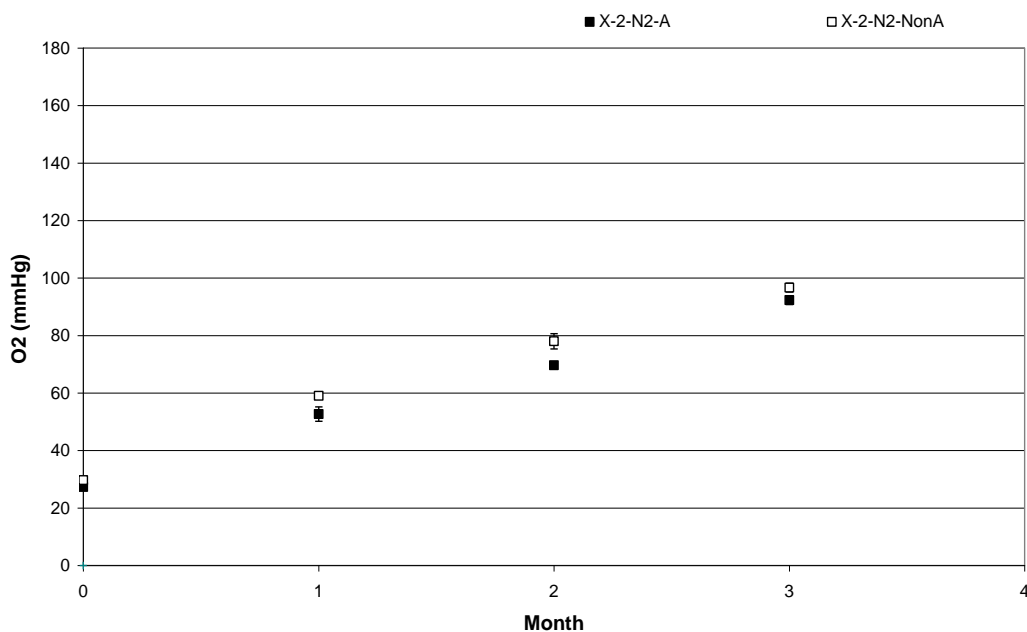

Figure 41: X 2 mg/mL, inerted, autoclaved and non autoclaved PO<sub>2</sub> trend at 40°C/75 % RH

The oxygen partial pressure showed an increase at condition 40°C/75 % RH. Syringes were not totally hermetic to external atmosphere and a partial regain of oxygen occurred. Values stayed close to 80 mmHg, nitrogen was still, in a minor way, protecting the formulation from a too strong oxidation.

## Studies at laboratory scale



### API ASSAY TREND ANALYZED BY UPLC

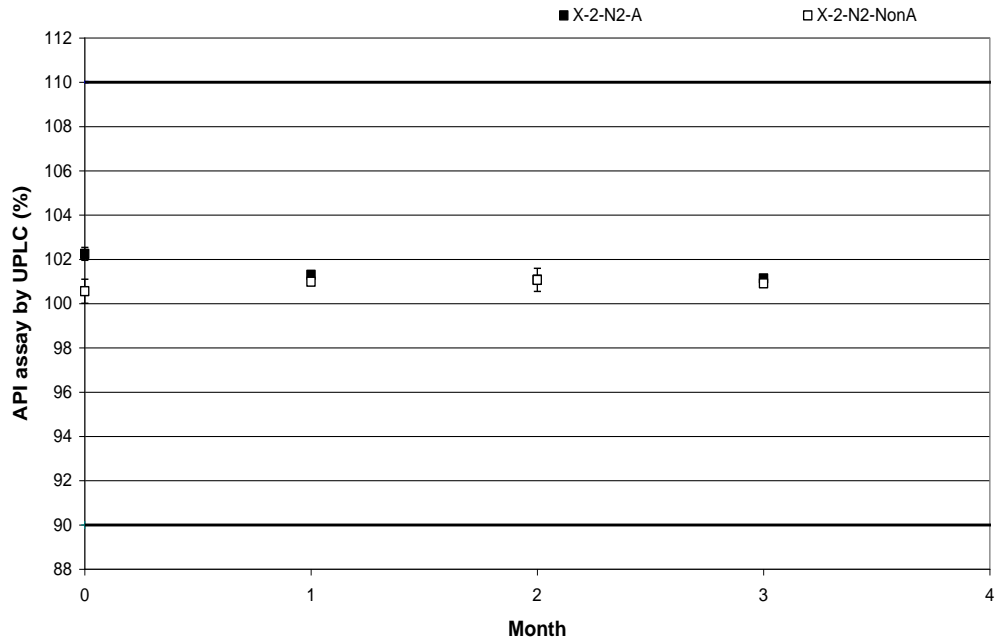

Figure 42: X 2 mg/mL, inerted, autoclaved and non autoclaved API assay trend at 40°C/75 % RH

API amounts stayed stable over time and in specifications all along the study as data at 80°C.



### TOTAL IMPURITIES ASSAY TREND ANALYZED BY UPLC

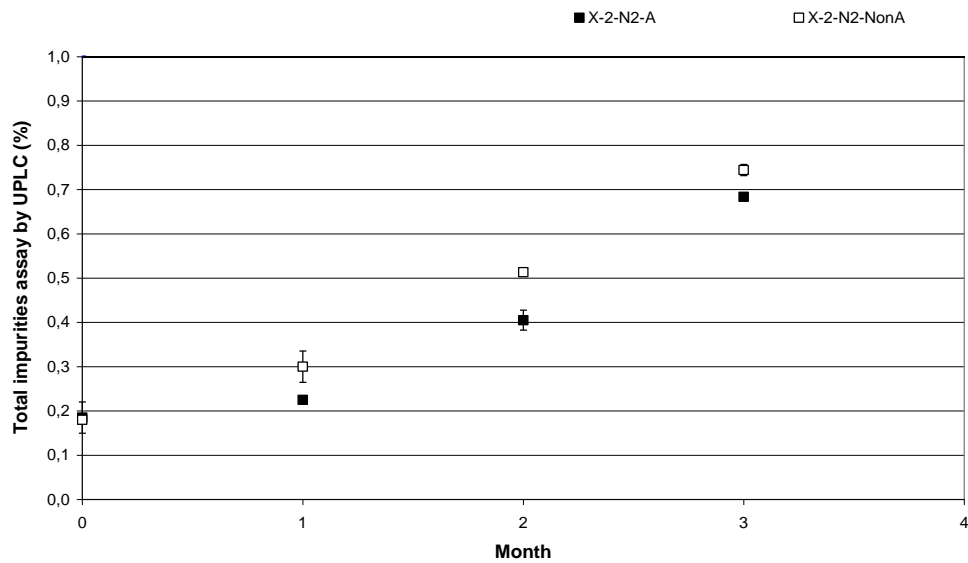

Figure 43: X 2 mg/mL, inerted, autoclaved and non autoclaved total impurities assay trend at 40°C/75 % RH

## Studies at laboratory scale

Impurities showed a dramatic increase for the condition 40°C/75 % RH as well as results for the study at 80°C. The total impurities content for the autoclaved formulation seemed less impacted. Amounts of total impurities were similar between this study and the one at 80°C.



### IMPURITY B ASSAY TREND ANALYZED BY UPLC

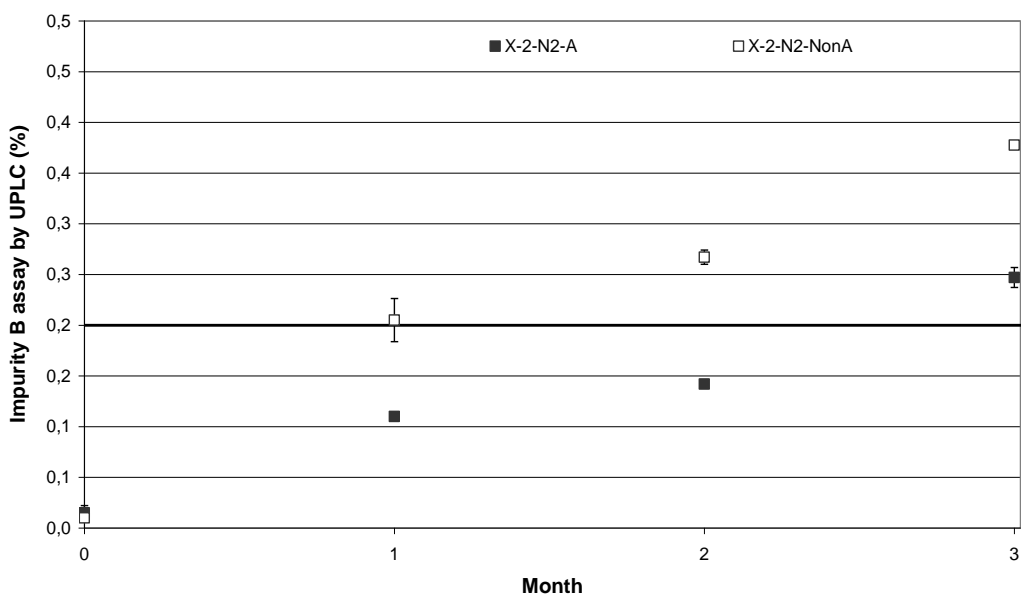

Figure 44: X 2 mg/mL, inerted, autoclaved and non autoclaved impurity B assay trend at 40°C/75 % RH

Regarding the impurity B amounts separately, it was still the main contributor to the high total impurities assay. Upholding data generated during the study at 80°C, the impurity B was more generated in the formulation “X 2-N2-NonA”.

## Studies at laboratory scale



### IMPURITY F ASSAY TREND ANALYZED BY UPLC

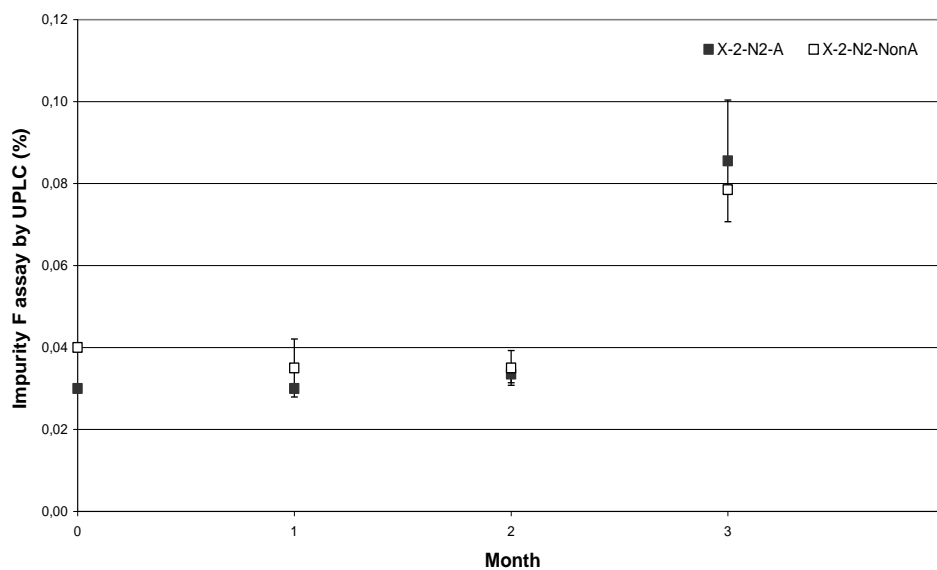

Figure 45: X 2 mg/mL, inerted, autoclaved and non autoclaved impurity F assay trend at 40°C/75 % RH

The impurity F amount increased over time but in a minor way compared to impurity B. This impurity amounts stayed far under specifications. Data have the same tendency than results at 80°C but the discrimination between the two formulations is less visible at 40°C/75 % RH.



## Studies at laboratory scale



### IMPURITY WITH RRT = 0.16 ASSAY TREND ANALYZED BY UPLC

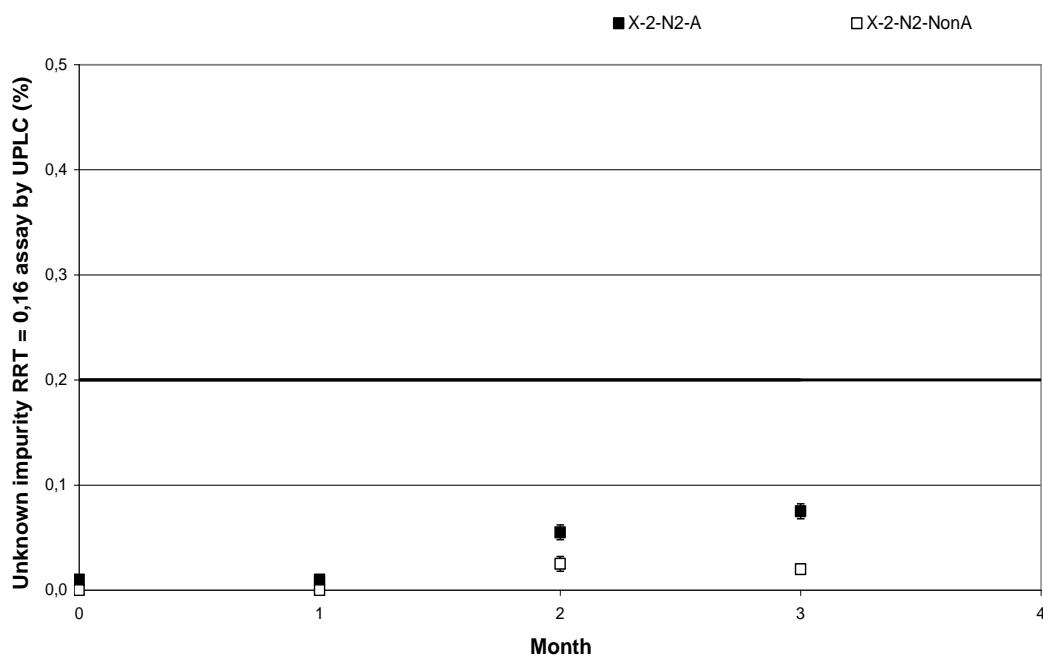

Figure 46: X 2 mg/mL, inerted, autoclaved and non autoclaved impurity with RRT = 0.16 assay trend at 40°C

The same unknown impurity with an RRT equal to 0.16 was detected during this study, its amounts was equal to the 80°C one, T6D at 80°C was equivalent to T2 months at 40°C/75 % RH. This impurity seemed more promoted in the formulation “X 2-N2-A”. However, its amounts stayed under specifications. Its behavior was interesting to watch as it was not generated at that level in previous pre-development forced degradation studies.

#### 3.5.2.3 DISCUSSION ON IMPURITIES AND INTERPRETATION

This study was set to evaluate the effect of steam sterilization on X injection under 40°C/75 % RH and 80°C when the formulation is put in its final packaging, Hypak® SCF syringes.

Both studies were performed in parallel to cross and compare results obtained in both conditions and complete data obtained in the first autoclave study performed in vials (see section 3.4.2.1).

## Studies at laboratory scale

This stability study showed that the API assay was not impacted by autoclaving or storage at 40°C/75 % RH and 80°C. It stayed stable and within specifications over time.

pHs of all formulations at 40°C/75 % RH as well as 80°C showed a little decrease (0.4 unit of pH for the highest decrease at 40°C/75 % RH and 0.9 pH unit for the highest decrease at 80°C). Most values were in specifications and did not change of more than one pH unit. This droop may not be significant.

A dramatic increase was observed in both conditions for the total impurities assay. From 0.20 % to 0.70 % for the 40°C/75 % RH study and from about 0.20 % to 0.80 % for the 80°C study. The first X degradation scorer was greatly promoted in formulations. As described before, impurity B seems impacted by autoclaving. This oxidation degradation product is less promoted in formulations that underwent autoclave.

Impurity F seems less impacted by autoclaving. Its amount increased over time in both conditions and stayed approximately equivalent in both formulations. At 80°C both formulations amounts were equal and ranged between 0.04 and 0.05 %. At 40°C/75 % RH, data at T3M were equal to 0.08 %, for other samples, values ranged from 0.03 to 0.04 %. Thus, impurity F content doesn't permit to discriminate one or the other formulation process.

Another interesting point was the appearance of an unknown impurity with RRT equal to 0.16. It was already generated during the first pre-development forced degradation study: "pH and inerting impact on formulations", in the air formulation at 80°C. It was mainly detected at T6D for pH 4.0, 5.0 and 6.5 (values respectively equal to 0.28, 0.27 and 0.30 %). At T2D, its amount ranged between 0.06 % and 0.10 % for the three pHs and was not detected at T0. This impurity was practically not detected at pH 2.5. For the same formulation performed under air and practically not detected at condition 40°C/75 % RH.

Its behavior was interesting to watch as it seemed to be promoted when the formulation was packed in syringes and underwent autoclave.

Impurities generated during the rubber compatibility study, when the formulation was in contact with the Tip-cap A, were practically not observed. Impurity A was present in all

## Studies at laboratory scale

samples at a very low level (approximately 0.04 %) and stayed stable over time in every condition.

A correlation is interesting to be performed between each formulation process (autoclaved/non autoclaved), oxygen level and the two major impurities amounts (B and RRT = 0.16). It could help assess the impact of steam sterilization on X formulation.

### Impurity B behavior at 80°C:

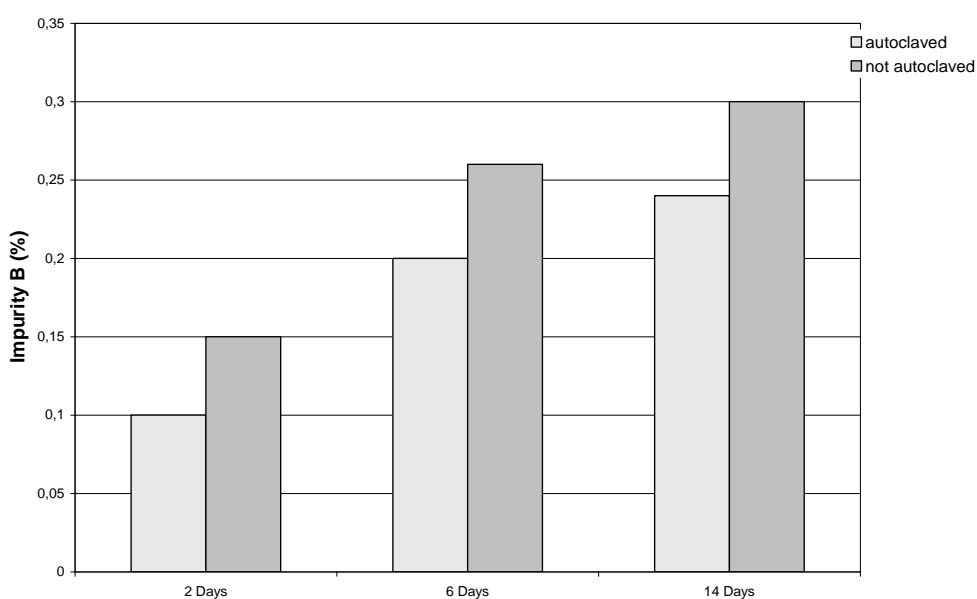

Figure 47: X 2 mg/mL, inerted, impurity B assay in function of autoclave at 80°C

The impurity B is highly promoted in syringes; more in non autoclaved samples than in others. As previously described, autoclave seems to protect X from a too strong degradation in the impurity B. A heat effect due to the time of storage at 80°C may also be responsible of the increase over time.

### Studies at laboratory scale

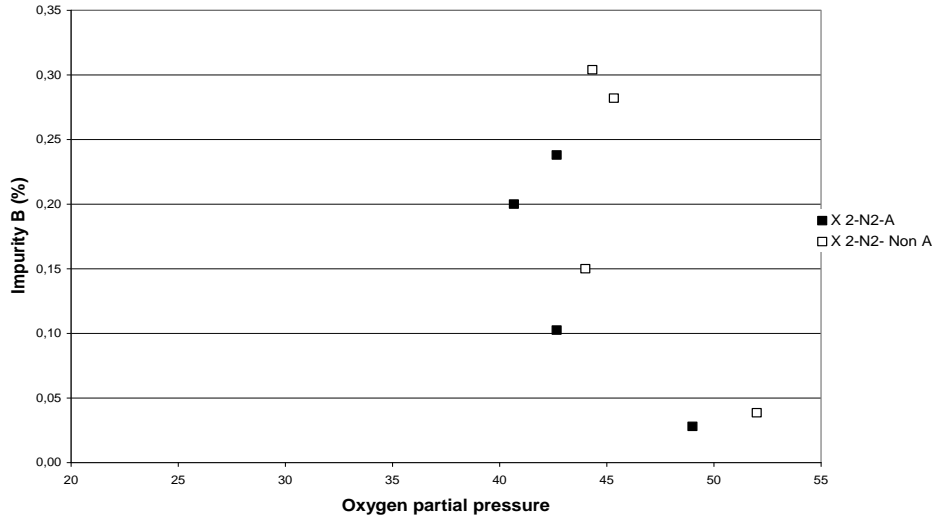

Figure 48: X 2 mg/mL, inerted impurity B in function of syringes oxygen partial pressure at 80°C

During the study at 80°C, no regain of oxygen was seen in syringes, all data were in the same range. The impurity B was only promoted in syringes that stayed a long time at 80°C (values between 0.20 and 0.30 %). This shows that impurity B may be promoted by heat degradation.

### Impurity B behavior at 40°C/75 % RH:

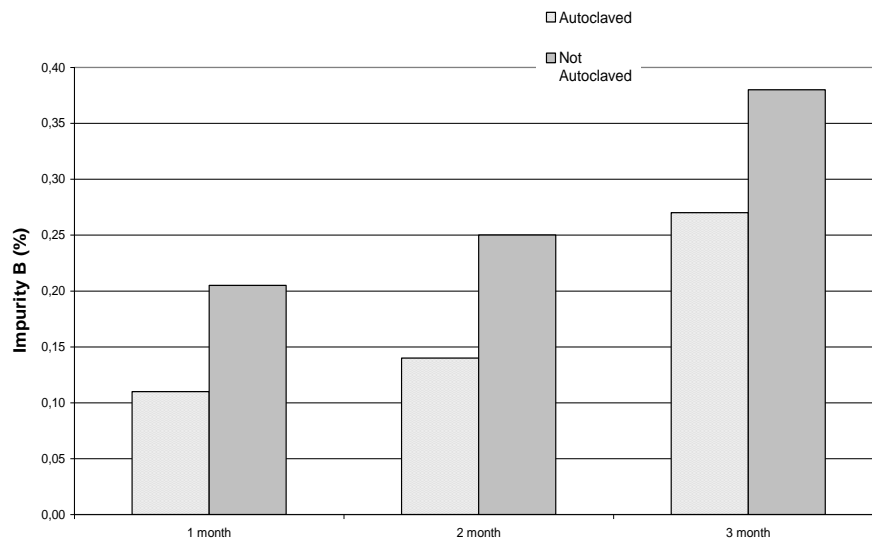

Figure 49: X 2 mg/mL, inerted impurity B assay in function of autoclave at 40°C/75 % RH

## Studies at laboratory scale

This histogram shows that impurity B is less promoted in the formulation autoclaved as showed data at 80°C. Two months at 40°C/75 % RH is practically equivalent to three months at 40°C/75 % RH, around 0.25 %. Its amount increased over time passed at 40°C/75 % RH. The highest value is observed at 40°C/75 % RH T3M: 0.37 % for the non autoclaved formulation. This confirms an activating effect of heat.

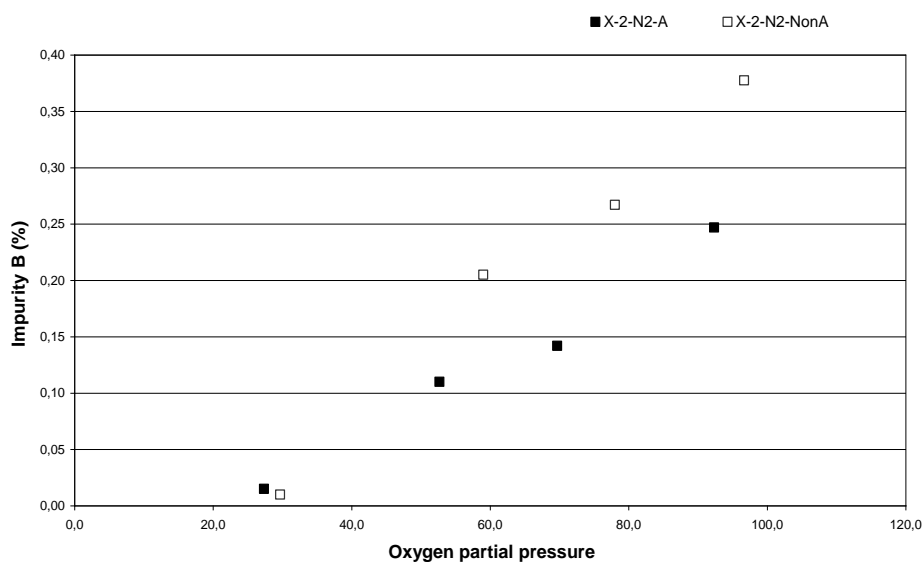

Figure 50: X 2 mg/mL, inerted impurity B assay in function of syringes oxygen partial pressure at 40°C/75 % RH

The graphic shows, better than at 80°C, that impurity B amounts is closely linked to the oxygen level in syringes. As syringes lost nitrogen and regain in oxygen, impurity B is promoted. There is an interval of about 0.10 % between the inerted and the non inerted formulation. This result goes in the line with bibliographic data which explained that impurity B is the main degradation scorer of the first degradation pathway: oxidation.

## Studies at laboratory scale

### Impurity with RRT = 0.16 behavior at 80°C:

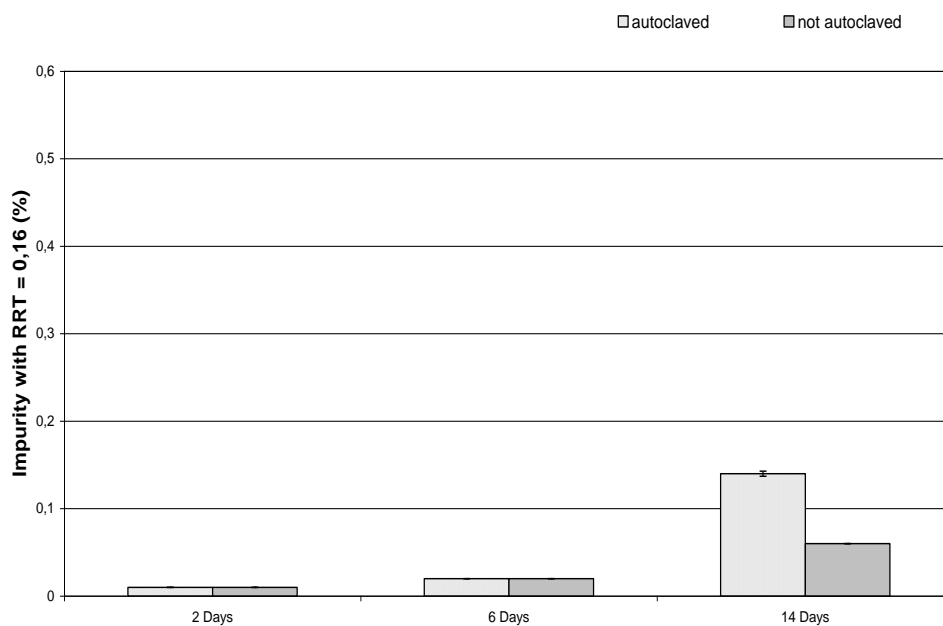

Figure 51: X 2 mg/mL, inerted impurity with RRT = 0.16 assay in function of autoclave at 80°C

This graphic shows that impurity with RRT = 0.16 is less promoted than impurity B.

At T14D, this impurity amount is more important in the formulation autoclaved (0.14 % for the formulation autoclaved and 0.06 % for the formulation non autoclaved). However, other samples do not show impurity content differences and values stay low.

## Studies at laboratory scale

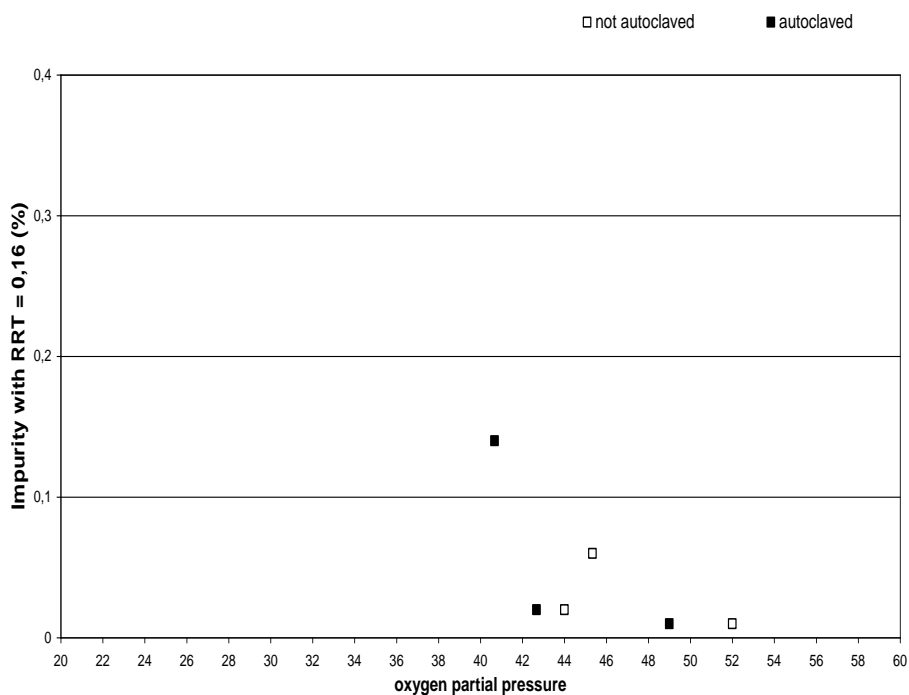

Figure 52: X 2 mg/mL, inerted impurity with RRT = 0.16 assay in function of syringes oxygen partial pressure at 80°C

As for the impurity B, this graph doesn't show a promotion of the impurity with RRT = 0.16 linked to the reuptake of oxygen in syringes. The impurity amounts are higher for the formulations that stayed 14D at 80°C. Heat may be responsible for the generation of the impurity with RRT = 0.16.

## Studies at laboratory scale

### Impurity with RRT = 0.16 behavior at 40°C/75 % RH:

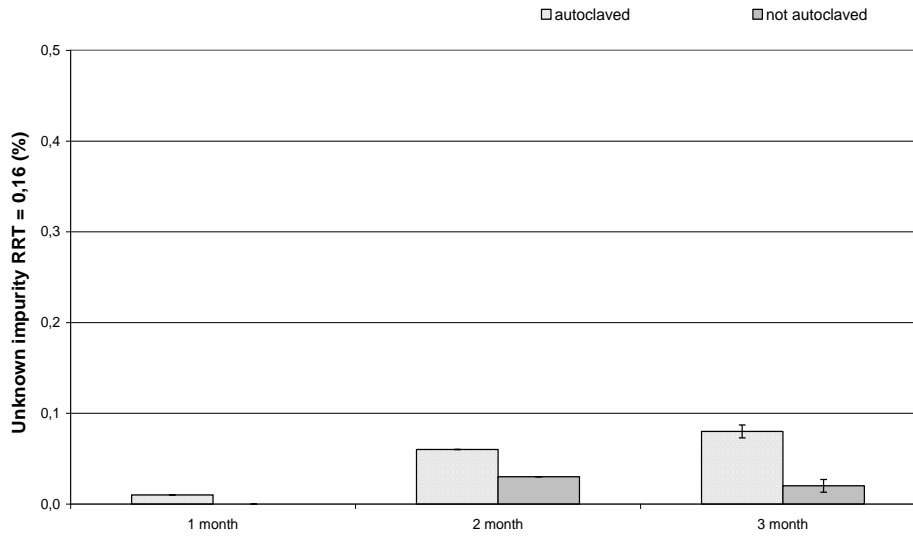

Figure 53: X 2 mg/mL, inerted impurity with RRT = 0.16 assay in function of autoclave at 40°C/75 % RH

At 40°C/75 % RH, a more precise discrimination is seen between the two formulation processes, autoclave seemed to generate more the impurity with RRT = 0.16. However, values stay low (always under 0.1 %). A heat effect is not to put aside as the increase also follows time passed in storage.

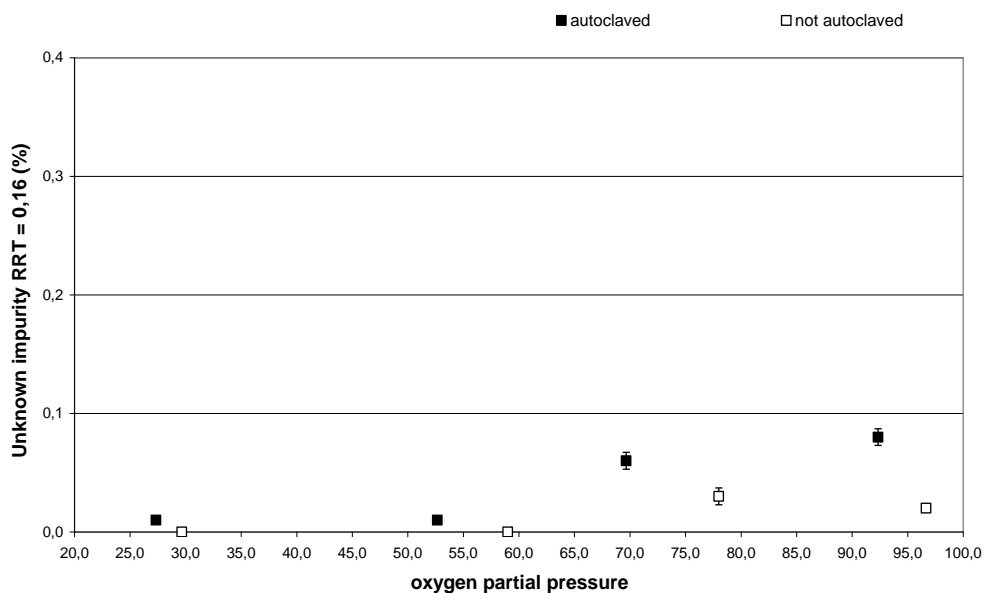

Figure 54: X 2 mg/mL, inerted impurity with RRT = 0.16 assay in function of syringes oxygen partial pressure at 40°C/75 % RH



## Studies at laboratory scale

Thanks to the data at 40°C/75 % RH, impurity with RRT = 0.16 is seen to be promoted when the oxygen content increases in Hypak® SCF syringes. This result could indicate that this impurity creation is due to the oxidation of X or to heat as the highest contents are seen in formulations that stayed longer in stability. In the first pre-development forced degradation study vials were hermetic and this impurity was also detected. The impurity may then be created by heat but no conclusion can yet be done about its origin.

---

### 3.5.2.4 CONCLUSION ON 40°C/75 % RH AND 80°C RESULTS

A more precise and complete study about impurities permitted to see that impurity B was less generated in autoclaved formulations and that a heat effect was probably also responsible of its increase. Impurity with RRT = 0.16 which seems to be promoted by heat/autoclaving or oxidation is detected in much less amounts and always stays in specifications.

The impurity B is the first X degradation scorer and, in every studies, the main contributor to the high total impurities content. Thus autoclaving is chosen for the formulation of X. Indeed, studies show that the best levels of impurity B and of total impurities are obtained with this process.

Finally the solution was found more stable at pH 5.0, under inerted conditions, in syringes with Stopper B and Tip-cap A and after autoclave.

However, in pre-stability study, impurity with RRT = 0.16 has to be watch as it seems to be promoted by autoclaving.

---

### 3.5.2.5 60°C STABILITY RESULTS

Autoclavability and stability test results at 60°C on a solution of X at a concentration of 2 mg/mL are presented in Table XIX:

## Studies at laboratory scale

### X solution appearance:

- Every T0 syringes were clear and colorless,
- Samples at T6D were clear and colorless,
- Samples after 14 days at 60°C were slightly pale yellow,
- After 28 days at 60°C, samples were slightly yellow, with a deeper color than T14D.

Generally speaking, all samples were free from particles.

Table XIX: X 2 mg/mL stability results at 60°C after autoclave

			X 2-N2-A			
Analytical tests	Specifications	RRT	T0	T6D	T14D	T28D
Appearance	Clear and colorless	-	C	C	NC	NC
Visual inspection	0 visible particles	-	C	C	C	C
pH	USP range (2.5 ≤ pH ≤ 6.5)	-	5,67	5,4	5,39	4.99
Osmolality (mOsm)	For information	-	289			
PO <sub>2</sub>	For information	-	28	45	57	72
X assay by UPLC (%)	90 % - 110 %	-	102.25	101.19	101.45	102.16
Total of impurities by UPLC (%)	NMT 1.0 %	-	<b>0.29</b>	<b>0.32</b>	<b>0.43</b>	<b>0.55</b>
Impurity A	NMT 0.2 %	1,4	0,05	0,03	0,04	0,06
Impurity B	NMT 0.2 %	1,27	0,02	0,1	0,16	<b>0,25</b>
Impurity C	NMT 0.2 %	1,49	0,03	0,03	0,05	0,05
Impurity D	NMT 0.2 %	0,35	0,04	0,04	0,04	0,03
Impurity E	NMT 0.2 %	1,21	0,02	0,02	ND	0,03
Impurity F	NMT 0.2 %	1,07	0,14	0,1	0,04	0,03
Impurity G	NMT 0.2 %	0,73	ND	ND	0,06	N/D
Impurity H	NMT 0.2 %	1,9	ND	ND	ND	N/D
Impurity of impurity G	NMT 0.2 %	-	ND	ND	ND	N/D
Unknown	NMT 0.2 %	0,27	0,01	0,01	0,04	0,08
Unknown	NMT 0.2 %	0,42	0,01	ND	ND	N/D
Unknown	NMT 0.2 %	1.15	ND	ND	0,01	0,03

C/NC: Reported as “C” if no change or matter is observed in solution appearance and clarity. If any change or matter is observed, “NC” is reported. ND: not detected, NR: not reported.

## Studies at laboratory scale



### *P*H TREND

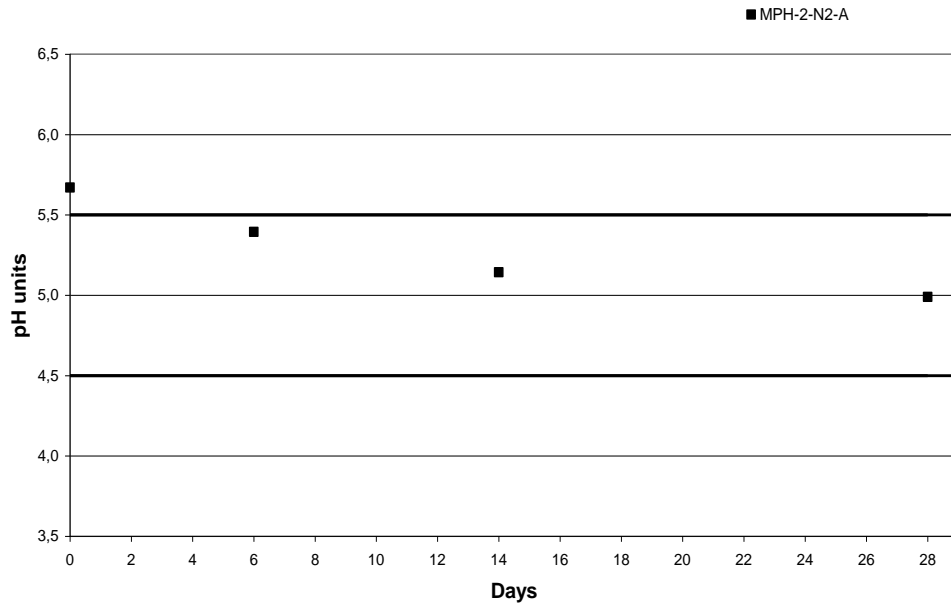

Figure 55: X 2 mg/mL, inerted, autoclaved pH trend at 60°C

The pH values showed a slight decrease. This result adds up data at 80°C and 40°C/75 % RH as they have the same tendency. However data were in specifications except T0 which pH was higher of 0.1 pH unit.



### *O*XYGEN PARTIAL PRESSURE TREND

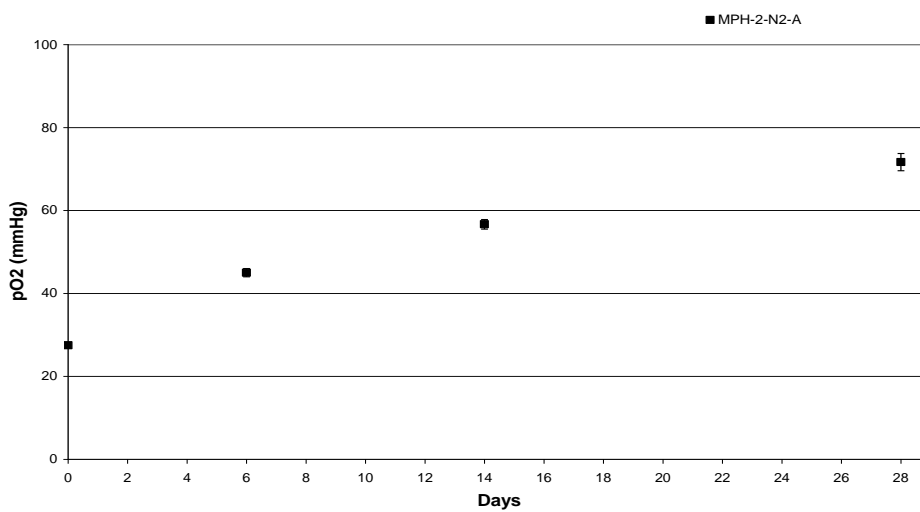

Figure 56: X 2 mg/mL, inerted, autoclaved PO<sub>2</sub> trend at 60°C

## Studies at laboratory scale

Regarding the partial pressure values, the same increase of oxygen was seen at 60°C than at 40°C/75 % RH. This trend adds up the previous hypothesis exposed that Hypak® SCF syringes may not be totally hermetical to external environment when stored. However, values stayed under 80 mmHg.

### ➤ *API ASSAY TREND ANALYZED BY UPLC*

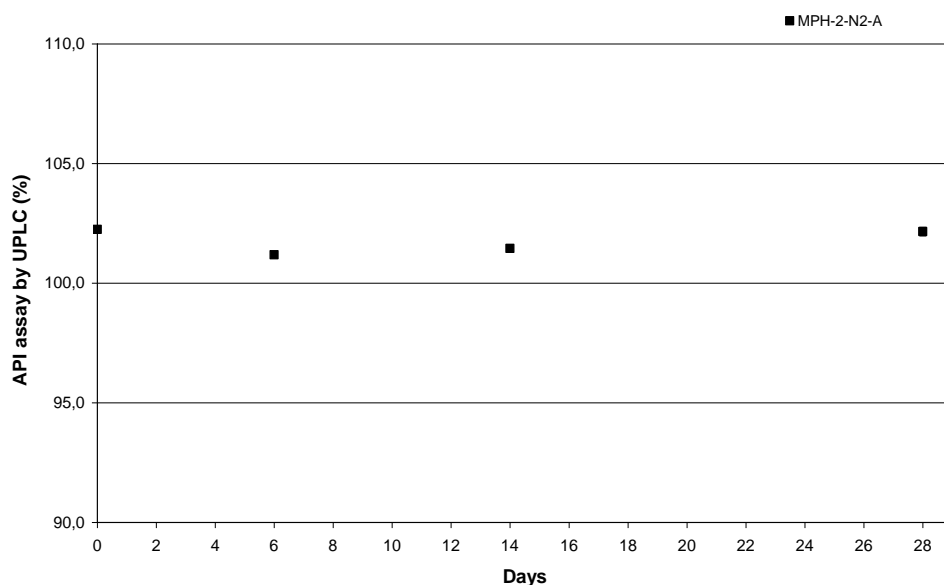

Figure 57: X 2 mg/mL, inerted, autoclaved API assay trend at 60°C

API assay remained stable and in specifications over time as data collected during the studies at 80°C and 40°C/75 % RH.

## Studies at laboratory scale



### TOTAL IMPURITIES ASSAY TREND ANALYZED BY UPLC

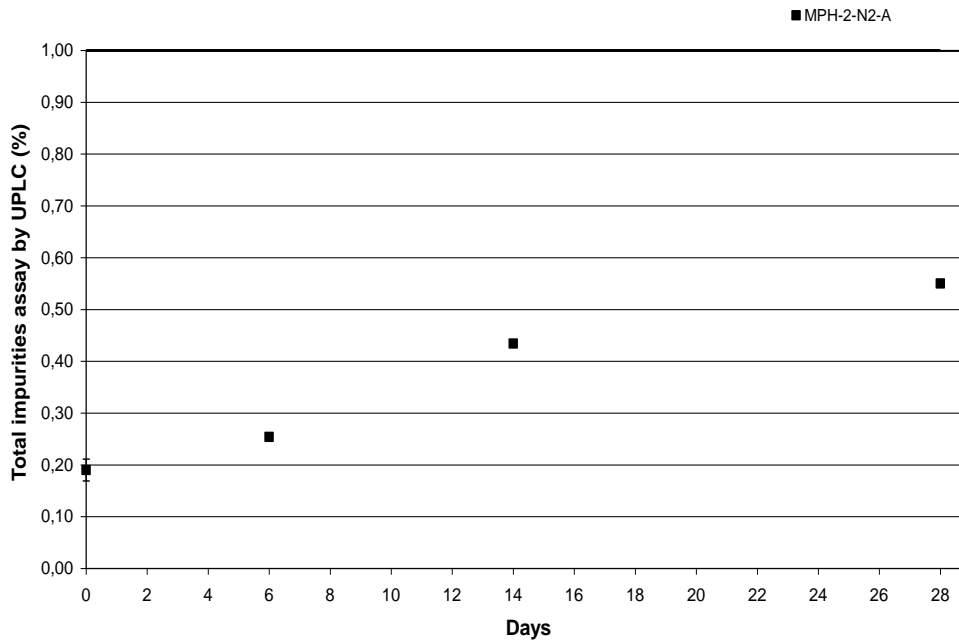

Figure 58: X 2 mg/mL, inerted, autoclaved total impurities assay at 60°C

Regarding the total impurities assay, data generated also add up results obtained at 80°C and 40°C/75 % RH. A great increase occurred during the storage at 60°C. This increase seemed to stabilize after T14D and values stayed in specifications.

## Studies at laboratory scale



### IMPURITY B ASSAY TREND ANALYZED BY UPLC

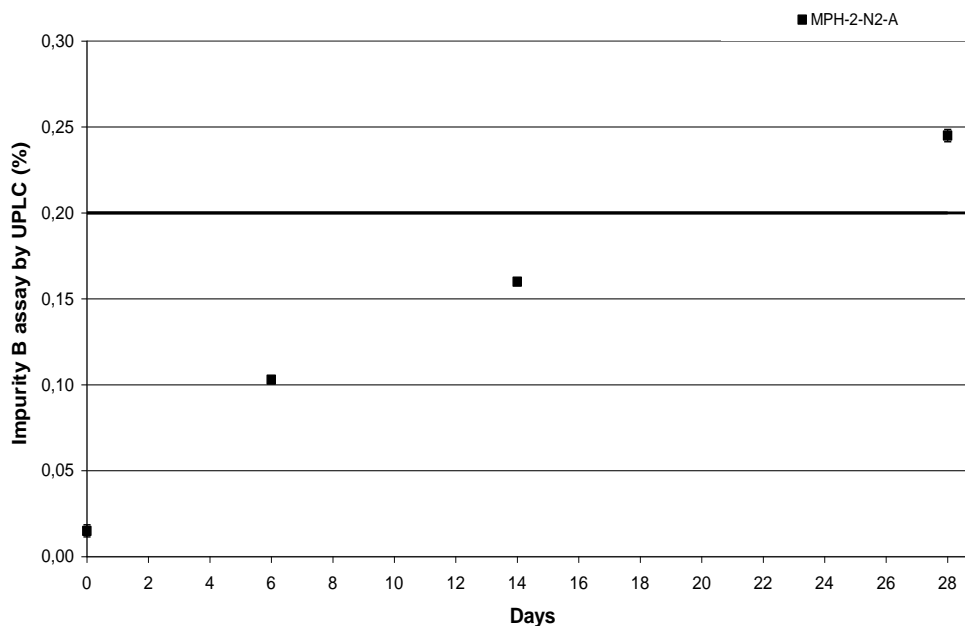

Figure 59: X 2 mg/mL, inerted, autoclaved impurity B assay trend at 60°C

The impurity B was still the main contributor to the high total impurities. This impurity was promoted but less in the inerted and autoclaved formulation. Values crossed specifications only after T14D. Impurity B creation will be to watch in future pre-stability points.

Studies at laboratory scale



*IMPURITY F ASSAY TREND ANALYZED BY UPLC*

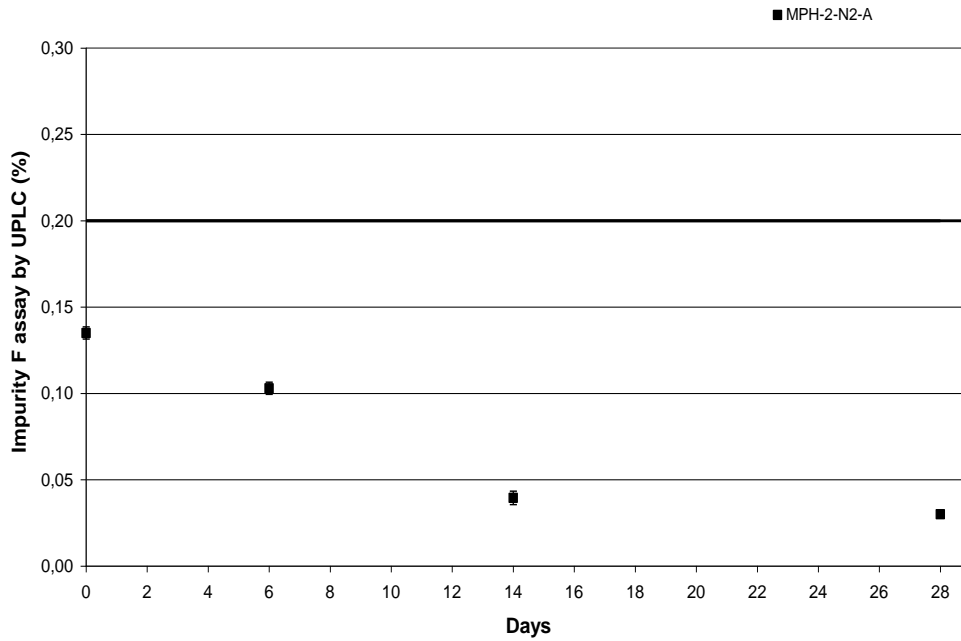

Figure 60: X 2 mg/mL, ineted, autoclaved impurity F assay trend at 60°C

The impurity F amounts decreased over time unlike other storage conditions. Values were always in specifications.

## Studies at laboratory scale



### IMPURITY WITH RRT EQUAL TO 0.16 ASSAY ANALYZED BY UPLC

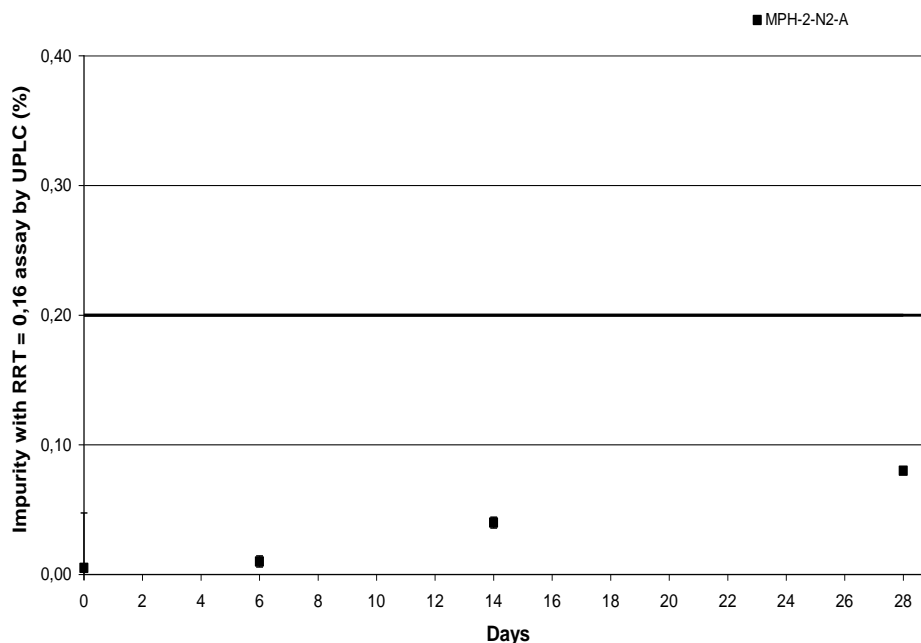

Figure 61: X 2 mg/mL, inerted, autoclaved impurity with RRT = 016 assay at 60°C

The same trend was seen for this impurity amounts during the three temperature studies. The impurity with RRT = 0.16 behavior is to watch in further pre-stability samples. It must not be over the specifications at all times of storage.

#### 3.5.2.6 DISCUSSION AND INTERPRETATION

First of all, it is obvious that trends at 60°C for every measurement add up data at 40°C/75 % RH as well as results at 80°C. Those data help getting more certain that the behavior seen is representative of the degradation occurring at 25°C.

Thanks to all results collected during the last forced degradation study, trends can be plot to help determine k (reaction rate) and Ea (activation energy) formulation's degradation.

It permits evaluating the method repeatability and extrapolating reaction kinetic and degradation behavior at 25°C. Universal kinetic equations based on the Arrhenius law are used.



## Studies at laboratory scale

The hypothesis that the API degradation reaction is order 1 is done as previously discussed in the “bibliography” paragraph.

The first thing to determine is  $k$  thanks to the first order equation below:

$$\ln\left(1 - \frac{i}{D_0}\right) = -kt \text{ with “}i\text{” equal to the total impurity content at time “}t\text{” and “}D_0\text{” equal}$$

the initial API content.

To check if the reaction follows an order 1,  $\ln\left(\frac{D_0 - i}{D_0 - i_0}\right)$  in function of time is plotted.

Curves will have “ $-k$ ” as slope.

“ $i$ ” represents the total number of impurities at time “ $t$ ” and “ $i_0$ ” the number of impurities at “ $t_0$ ”. The final display will be the Figure 62 below.

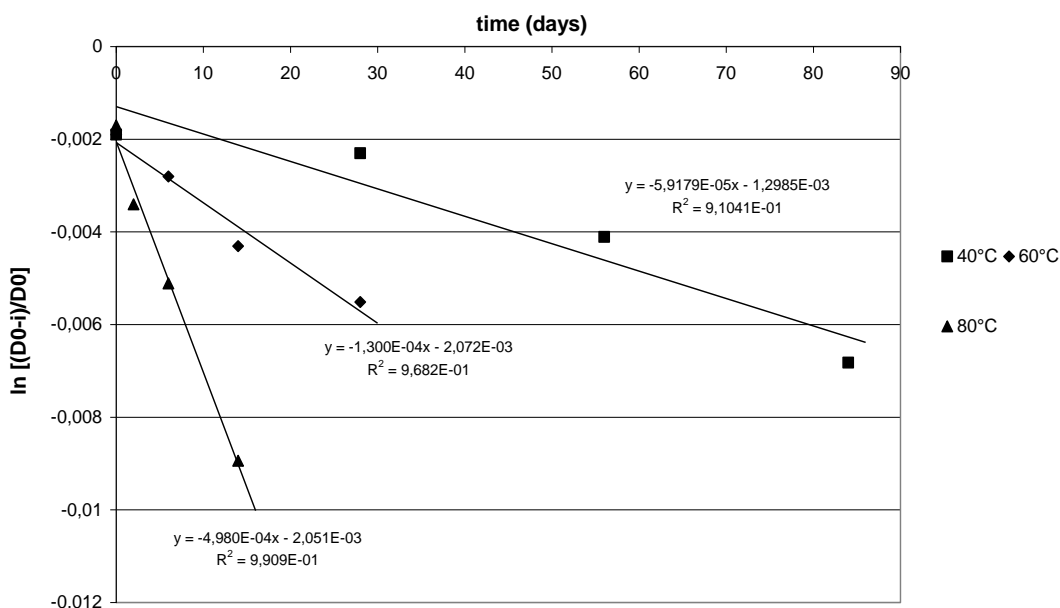

Figure 62:  $\ln(D_0 - i)$  in function of time for 40°C, 60°C and 80°C

The graphic data validate the hypothesis that the reaction rate was order 1. Curves with “ $R$ ” very close to 1 for every temperature conditions are obtained. “ $k$ ” are then extracted from each linear equation:

## Studies at laboratory scale

$$k_{40^{\circ}\text{C}} = 5.918 \times 10^{-5} \text{ days}^{-1}$$

$$k_{60^{\circ}\text{C}} = 1.300 \times 10^{-4} \text{ days}^{-1}$$

$$k_{80^{\circ}\text{C}} = 4.980 \times 10^{-4} \text{ days}^{-1}$$

Knowing "k",  $Q_{20}$  can be calculated.

$Q_{20}$  is the coefficient with which the reaction rate "k" will be multiplied if the temperature of the reaction is increased by 20°C (see schema below):

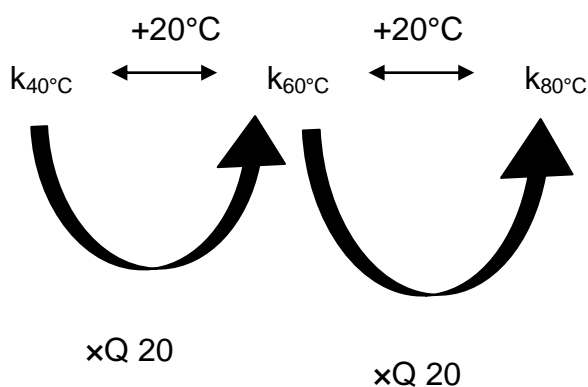

Schema 1:  $Q_{20}$  application to X pre-development forced degradation studies

Between  $k_{40^{\circ}\text{C}}$  and  $k_{60^{\circ}\text{C}}$  the coefficient is approximately equal to 2.2, between  $k_{60^{\circ}\text{C}}$  and  $k_{80^{\circ}\text{C}}$  the coefficient is approximately equal to 3.83.

It can be approximated that reactions are more representative of an ambient degradation at lower temperatures (40°C and 60°C).  $Q_{20}$  equal to 2.2 will then be used.

However, the two  $Q_{20}$  values found are really close validating that degradations and reaction rates are repeatable in experiments.

The activation energy of the degradation is calculated thanks to  $\ln(k)$  in function of  $(1/T)$ .

This curve plot will have " $-\frac{Ea}{R}$ " as slope (see Figure 63). Thanks to the  $Ea$  value found,

25°C extrapolation will be obtained.

## Studies at laboratory scale

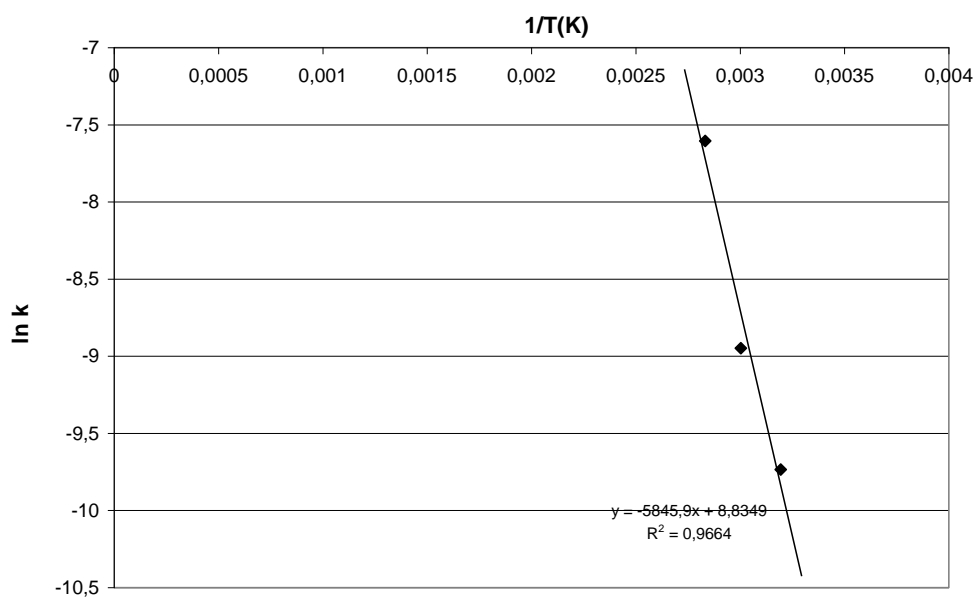

Figure 63: ln k function of 1/T for 40°C, 60°C and 80°C.

Slope of the line is “  $-\frac{Ea}{R}$  ”.

$$-\frac{Ea}{R} = -5845.9 \quad (R = 8.314 \text{ J.K}^{-1}.\text{mol}^{-1}). \quad Ea = 48.6 \text{ kJ.mol}^{-1}.$$

### 3.5.2.7 CONCLUSION ON 40°C/75 % RH, 60°C, 80°C RESULTS AND CORRELATION

If degradation of X was only occurring by oxidation, Ea would have been close to  $100 \text{ kJ.mol}^{-1}$ , which is the theoretical value for a molecule oxidation degradation pathway.

Oxidation is considered as the major degradation occurring to X structure, some impurities are promoted by the syringes oxygen reuptake (impurity B for example), but it was seen that other degradations may occur, due to contact with rubbers, heat or light exposition. Analytical forced degradations proved that heat also generated impurity B.

## Studies at laboratory scale

Moreover, in the last study at 40°C/75 % RH, 60°C and 80°C, where calculus are based on, other impurities probably not only due to oxidation, like RRT= 0.16, appeared and influenced results.

In addition, forced degradation studies cannot permit to extrapolate the syringes oxygen present in solution. At 80°C, no oxygen variation was seen in syringes whereas at 40°C/75 % RH and 60°C the phenomenon occurred. It depends on too many parameters (rubber behavior, heat, humidity...). This phenomenon is generally seen when long times of storage are applied.

Thanks to data at 40°C/75 % RH, 60°C and 80°C, an extrapolation can be done to determine the formulation behavior in ambient conditions of storage (25°C).

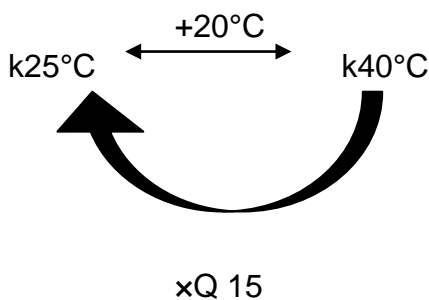

Schema 2: Q<sub>20</sub> application at 25°C conditions

The equation  $Q_{\Delta t} = Q_{10}^{\frac{\Delta t}{10}}$  can be used to find Q<sub>15</sub>.

$Q_{15} = Q_{10}^{1.5}$  We can say that Q<sub>10</sub> is equal to  $\sqrt{Q_{20}} = \sqrt{2.2} = 1.48$ . So  $Q_{15} = 1.48^{1.5} = 1.8$ .

k<sub>25°C</sub> can now be found with the relation:  $k_{25°C} = \frac{k_{40°C}}{Q_{15}} = 3.288 \times 10^{-5} \text{ days}^{-1}$ .

It is interesting to know, for the development of a formulation, when total impurities content will reach the 1 % acceptance criteria at 25°C. At what time the API will be degraded at 1 %? Which amounts to search t<sub>99 %</sub>, where formulation degradation will left 99 % of the API intact.

## Studies at laboratory scale

$$t_{99\%} = \frac{-\ln 0.99}{k_{25^{\circ}C}} = 306 \text{days} \quad t_{99\%} = 0.85 \text{ years} = 10.2 \text{ months}$$

The 1 % impurities amount will be reach in the formulation after approximately one year at 25°C.

This value gives an indication of the API behavior at 25°C. As said before, the forced degradation studies method has limits and cannot extrapolate all phenomenon linked to the formulation stability. The result gives an idea about what can be found at 25°C but as to be compared to pre-stability results which will be more linked to the real behavior of the formulation.

---

## CONCLUSION

This report presents the implementation and optimization of pre-development forced degradation studies for formulations screening improvement. The goal of the study was the research and application of a safe, rapid and convenient way to collect concrete data about a molecule sensitivity and formulation stability facing drastic conditions of pH, heat, light, oxygen level for example. This work was performed during an eight month study in Becton Dickinson Company, in Pont de Claix.

A bibliographic research was first carried out to evaluate and clarify various tests, and techniques used. It allowed also determining stress conditions to be applied and the major factors influencing solutions stability.

This study led to the establishment of a work instruction that describes a methodology for pre-development forced degradation studies.

The forced degradation tests were applied, at laboratory scale to evaluate molecules sensitivity and formulations stability.

First experiments were useful to evaluate active ingredients behavior when exposed to stress comparatively to theoretical data found and to refine tests parameters to be used in the protocol.

A study was then set on a specific molecule at its pre-development stage. The results exposed in this thesis helped determine the optimal formulation stability conditions. Those tests showed that the solution studied was more stable when formulated at pH 5.0 and under nitrogen flush. Moreover, the more appropriate syringe's stopper was determined after a study of the interactions between the syringe's components and the formulation.

Also, steam sterilization was shown to be the appropriate process for the formulation.

## Conclusion

The objective for this work was to set a correlation between all generated stability results at different temperatures. Results showed same trends at three different temperatures: 40°C, 60°C and 80°C in every study. In addition, following chemical universal kinetic laws, experiments were reproducible and didn't followed a modified degradation kinetic comparatively to ambient temperature conditions. Finally, combination of 40°C, 60°C and 80°C results permitted to obtain stability data at 25°C by extrapolation.

The extrapolated data have, of course to be correlated to pre-stability studies currently in progress at 25°C and 40°C as well as stability studies carried out with pilot batches.

The developed methodology will permit to determine sensitivity of active ingredients currently in project, specifically molecules with poor bibliographic data.

## Conclusion

THESE SOUTENUE PAR : Florie Guillaumin

TITRE : Implémentation et optimisation d'études de dégradations forcées en pré-développement pour l'amélioration du screening des formulations.

### CONCLUSION

Cette thèse présente l'implémentation et l'optimisation d'études de dégradations forcées en pré-développement pour l'amélioration du screening des formulations. L'objectif de l'étude était de rechercher et d'appliquer une méthodologie reproductible, rapide et facile à mettre en œuvre pour réunir des données concrètes sur la sensibilité des molécules et la stabilité des formulations lorsque mises en condition drastiques de pH, chaleur, lumière, taux d'oxygène, par exemple. Les expériences ont été réalisées dans le cadre d'un stage de fin d'étude de huit mois au sein de la société Becton Dickinson, à Pont de Claix.

Une étude bibliographique a tout d'abord été menée pour évaluer les différents tests et techniques utilisées. Cette recherche a permis d'identifier les facteurs les plus influents sur la stabilité des formulations et de préciser les conditions de stress à appliquer.

Cette étude a abouti à la rédaction d'un protocole qui décrit une méthodologie de réalisation des tests de dégradations forcées en pré-développement.

Les tests de dégradations forcées ont été appliqués à l'échelle du laboratoire pour évaluer la sensibilité des molécules et la stabilité des formulations.

Les premiers tests ont permis d'évaluer la réponse des principes actifs lorsque exposées à de fortes conditions de stress par rapport aux données théorique de bibliographie et d'affiner les paramètres à retenir dans le protocole.

Une étude a ensuite été menée sur une molécule spécifique au stade de son pré-développement. Les résultats obtenus ont aidé à la détermination des conditions



## Conclusion

optimales de stabilité de la formulation. Tout d'abord, il a été démontré une stabilité accrue de la solution à pH 5.0 et sous inertage à l'azote. Ensuite, le joint de piston de la seringue a été déterminé après une étude menée sur l'interaction de la formulation avec les constituants de la seringue.

De même, la dernière étude a montré que l'autoclavage, était le processus approprié de stérilisation pour la formulation.

L'objectif de ce travail était aussi d'établir si une corrélation était possible entre toutes les données de stabilité générées aux différentes températures. Les résultats ont montré les mêmes tendances à trois températures différentes : 40°C, 60°C et 80°C dans chaque étude menée. De plus, suivant les règles de cinétique chimique universelle, les expériences sont reproductibles et n'ont pas une cinétique de dégradation modifiée par rapport aux conditions de température ambiante. Enfin, la réunion des derniers résultats à 40°C, 60°C et 80°C a permis d'obtenir des données de stabilité à 25°C par extrapolation.

Des études de pré-stabilité sur cette molécule sont actuellement en cours à 25°C et 40°C ainsi que d'autres études de stabilité sur des lots à l'échelle pilote. Les résultats de ces études seront à corréler avec les données extrapolées.

La méthodologie mise en place lors de ce travail va permettre de déterminer la stabilité de principes actifs en projet actuellement et particulièrement ceux dont les recherches bibliographiques ne donne que peu d'information.

VUE ET PERMIS D'IMPRIMER

Grenoble, le 30 Nov 2010

LE DOYEN

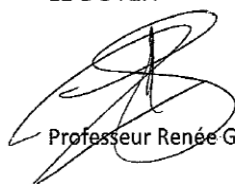
  
Professeur René GRILLOT



LE PRESIDENT DE LA THESE

  
Professeur Aziz BAKRI

Page 128 / 147

---

## BIBLIOGRAPHY

*The bibliography of this work is not presented here for confidentiality concerns.*

*La bibliographie de ce travail n'est pas présentée ici par souci de confidentialité.*

---

# APPENDIX

## Appendix 1: Global chemical kinetic and Arrhenius law

### Chemical kinetic

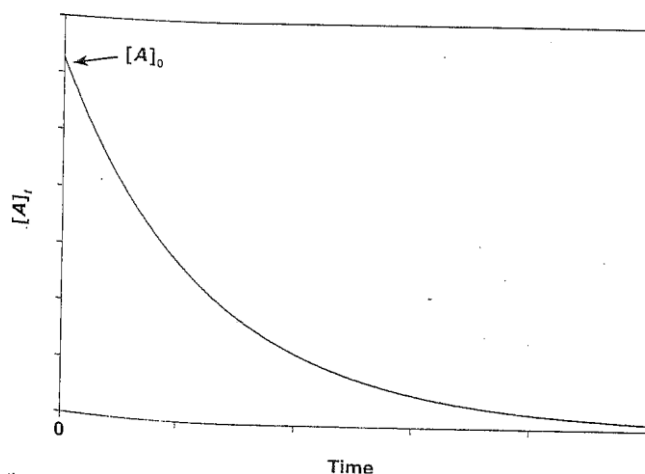

Figure 64: Plot of concentration of A versus time for a first-order reaction

Figure 64 shows a typical plot where reactant A exponentially decays to products according to the following Equation 4. The rate of the reaction decreases with time as the concentration of the reactant decreases.

$$[A]_t = [A]_0 e^{-kt}$$

Equation 4: First order integrated rate equation

Equation 5 suggests that a natural logarithm plot of the reactant concentration as a function of time should give a linear plot with a slope equal to  $-k$  and a  $y$  intercept equal to the natural logarithm of the initial reactant concentration.

$$\ln[A]_t = -kt + \ln[A]_0$$

Equation 5: Equation 6 linearized by rearrangement

This plot, Figure 65, is commonly used and found in the literature for first order reactions.

## Appendix

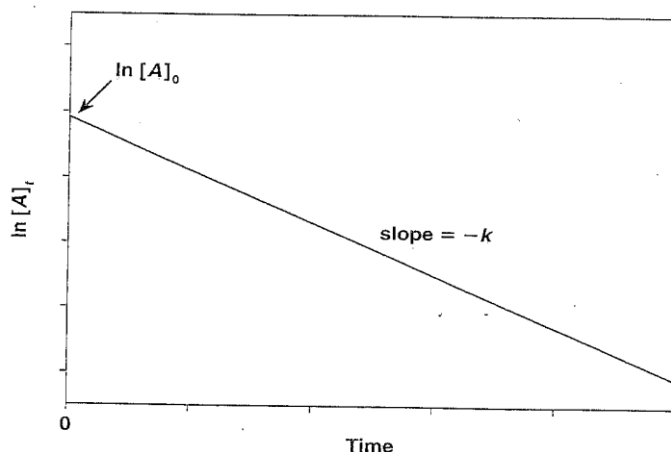
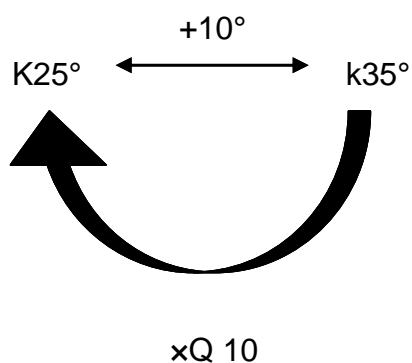

Figure 65: Plot of the natural logarithm of the concentration of A versus time for a first-order reaction

In active ingredients stability, it is necessary to determine the time taken for the loss of 5 % of the drug, leaving 95 % of the original drug concentration. It can be represented by  $[A]_t = 0.95 [A]_0$  at  $t = t_{0.95}$ . It can be determined, if the rate constant is known by substituting the expression into Equation 4 and rearranging it yielding to:  $T_{0.95} = \ln 0.95/k$ .

Using high temperatures to increase the rate of a chemical reaction is a common laboratory procedure. The rate of most solvolytic reactions of pharmaceuticals is increased roughly 2 to 3 fold by a  $10^\circ$  increase near room temperature which is the  $Q_{10}$  notion represented by the schema below:



## Appendix

### Arrhenius law

Arrhenius noted that the variation with temperature of the rate constant of chemical reactions could be expressed by  $k = Ae^{\frac{-Ea}{RT}}$  where, according to collision theory, “Ea” is the Arrhenius activation energy, the pre exponential term, “A” is a constant called the frequency factor; “R” is a gas constant (8.314 Joule/mol<sup>-1</sup>); and ‘T’ is the absolute temperature. This is a linear dependence of the natural logarithm of the reaction rate “k”, versus the reciprocal of the absolute temperature “T”. This equation is valid so long as the reaction mechanism does not change over the temperature range studied.

But non linear Arrhenius behaviors occur in many cases such as:

- Phase transitions,
- pH shifts,
- Uncontrolled relative humidity,
- Complex reaction mechanisms,
- Change in Arrhenius parameters with temperature,

To take into account these behaviors, it is possible to use the modified Arrhenius relationship that follows:

$$k = AT^n \cdot e^{-Ea/RT}$$

Equation 6: Modified Arrhenius equation

Where “A”, “n” and “Ea” are parameters determined using nonlinear fitting programs.

This equation can be mathematically simplified to give:

$$\ln(k) = \alpha - \beta \ln(m) - \gamma m$$

Equation 7: Modified and simplified Arrhenius equation

Here, “m” equals 1/T, and “α”, “β” and “γ” are fitted parameters based on a linear least square fit to the experimental data.

## Appendix

A plot of the natural logarithm of the rate constant versus the reciprocal of the absolute temperature in which the rate constant are determined gives a negative slope that is equivalent to “ $-E_a/R$ ”. If a nonlinear plot is obtained, a thermally induced change in the reaction mechanism probably has occurred and thus the Arrhenius equation cannot be used.

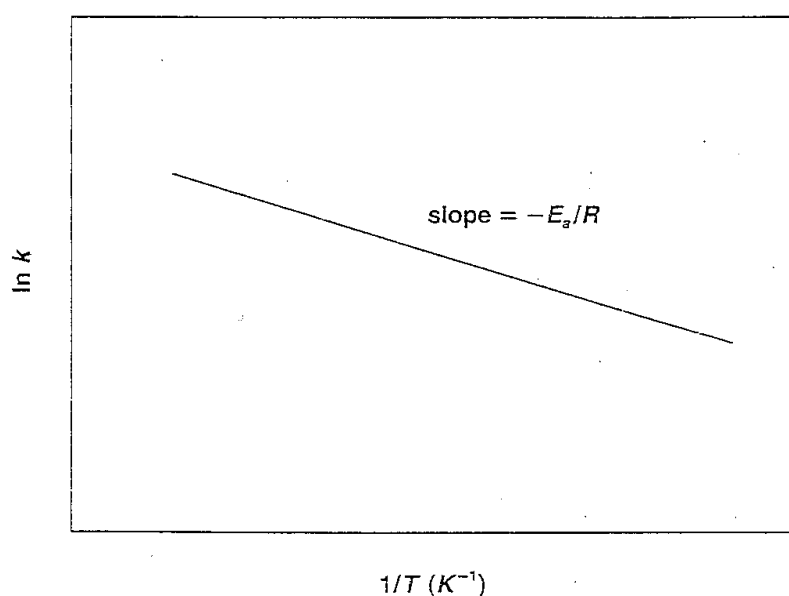

Figure 66: Variation of the rate constant with reciprocal absolute temperature, illustrating the Arrhenius equation

This relation will be useful to calculate “ $E_a$ ” for a reaction and thus to extrapolate rate reactions and degradation kinetic at another temperature than the one tested. It will be possible to find reaction rate at 25°C with accelerated tests at 80°C, 60°C or 40°C.

## Appendix 2: Forced degradation general protocol

### Forced degradation global protocol

#### I. Objective

During the development of drugs in pre-filled syringes, BD's R & D section wants to collect concrete data about APIs' sensitivity and formulations stability. It includes the study of degradation behavior of molecules facing exposure to several high temperatures (>40°C) light, variations of oxygen level during formulation and devices compatibility (stopper, barrel, tip cap).

When not controlled, the possible degradation phenomenon can generate API degradation, emergence of impurities potentially toxic and finally a sensitivity variation that can lead to cost and extended development time.

It is then suggested to anticipate those sensitivity problems with an early formulation screening. Solutions will undergo stress conditions. This will help find in a short time their specific sensitivity and thus the most stable formulation. This protocol helps determine parameters that will be used to stress active pharmaceuticals ingredients and formulations.

#### II. Methodology

##### Product characterization:

- The solution to test is an original formulation done by the R&D formulation service.

##### Measures to perform:

- UV and UPLC analyses (to have API degradation profile).
- pH measurement
- Oxygen partial pressure measurement when applicable.

## Appendix

- Organoleptic analyze (color, particles, precipitate...)

### Tests to perform:

Tests conditions described below are bases ones. According to bibliographic information collected for each product or to the fluctuating sensitivity of APIs to those first tests, conditions and parameters could change.

① Oxidation: Compare a solution formulated under air and one formulated under nitrogen to determine if the solution is more stable when inerted or not.

② Heat: repeat autoclave cycles conditions to determine if the solution can bear this type of sterilization.

Heat sensitivity will also be considered when the formulation has to be put at different high temperatures (80°C, 60°C or 40°C) to fasten the degradation reaction kinetic.

③ Suntest at 550 W/m<sup>2</sup>: Determine if the API in formulation degrades when expose to light respecting ICH Q1B guidelines conditions.

④ pH variations: determine, in the final product USP range, the optimum pH of stability.

⑤ Rubber compatibility (tip cap and stoppers): determine if the solution matches primary packaging components.



## Appendix

### Material:

- pH-meter
- Oxygen meter
- Rubbers (Stopper A or B and Tip-cap A)
- UV spectrophotometer
- Oven
- Sun test designed to produce an output similar to the D65/ID65 emission standard.  
(Respect of ICH Q1B guidelines: 550 W/m<sup>2</sup> pendant 24 h).
- UPLC or HPLC lines
- Schott bottles, vials and syringes as container for tests

### **III. Process**

- Part of the tested solution will be kept in ambient conditions of storage and will be considered as T0.
- Part of the tested solution will be exposed to stress conditions of storage.

#### ① Oxidation:

- Prepare 2 flasks of formulation (same formula): one under air, the other under nitrogen.
- Split each flask: in 3 vials.
- Put 2 vials in the oven at 80°C, one will be sampled at T2 days and the other at T6 days.  
The third bottle or vial will be kept in ambient atmosphere of storage (T0).

## Appendix

- Compare inerted and non inerted vials at T0, T2 days and T6 days (API assay, impurities, pH, Oxygen if relevant).

### ② Heat:

- Prepare a formulation to fulfill 2 vials.
- Put one vial in an oven (or an autoclave) in order for it to undergo 1 or 2 cycles of 20 minutes at 121°C. Keep the other vial for T0 analysis.
- Compare vials before and after 1 and 2 autoclave cycles (API assay, impurities, pH, Oxygen if relevant).

### ③ Suntest:

- Prepare 6 syringes (or more, depending on the number of syringes required to make the analyses) of the solution and put them in a suntest to be exposed to light 30 minutes, 2 hours and 24 hours.
- Half of these syringes will be protected with aluminum foils to be control samples.
- Analyze all the syringes after the stress test (API assay, impurities, pH, Oxygen if relevant) and compare the results.

### ④ pH range:

- According to the pH USP range on the drug product monograph, formulate 1 L of solution.
- Split the solution into 150 mL fractions and adjust each one to a different pH (example: adjust the solution 1 at the upper USP limit, the solution 2 at the lower USP limit, the solution 3 at an intermediary pH).

## Appendix

*Note: if the solution contains a buffer, prepare primarily the different buffers to add into the solutions.*

- Split each 150 mL in 3 vials (if the molecule is sensitive to oxygen, the vials are recommended because they are hermetic),

- Place 2 vials in the oven at 80°C. One will be sampled at T2 days, the other at T6 days. The third will be stored in ambient conditions (T0) and analyzed rapidly.

- Compare vials with different pH adjustments at T0, T2 days and T6 days (API assay, impurities, pH, Oxygen if relevant).

⑤ Rubber compatibility: example with two stoppers compositions: Stopper A and Stopper B.

Prepare:

- 1 vial of the tested solution with a calculated quantity of tip cap,
- 1 vial of the tested solution with a calculated quantity of stopper A,
- 1 vial of the tested solution with a calculated quantity of stopper B,
- Place each vial vertically in the oven at 80°C during 2 weeks (after having sterilized 20 minutes at 121°C in the autoclave if the product is not heat sensitive).

Sample one vial at T0, one at T1 week and one at T2 weeks, analyze the results (API assay, impurities, pH) and compare the stability of the solution with each rubber component.

Those conditions of tests can be reproduced with syringes as components.

Appendix

**Appendix 3: X degradation sample: under air, pH 2.5, 6 days at 80°C and blank- Zoomed on area of interest**

Appendix 3 shows a chromatogram of the sample formulated under air at pH 2.5 and after 6 days of storage at 80°C.

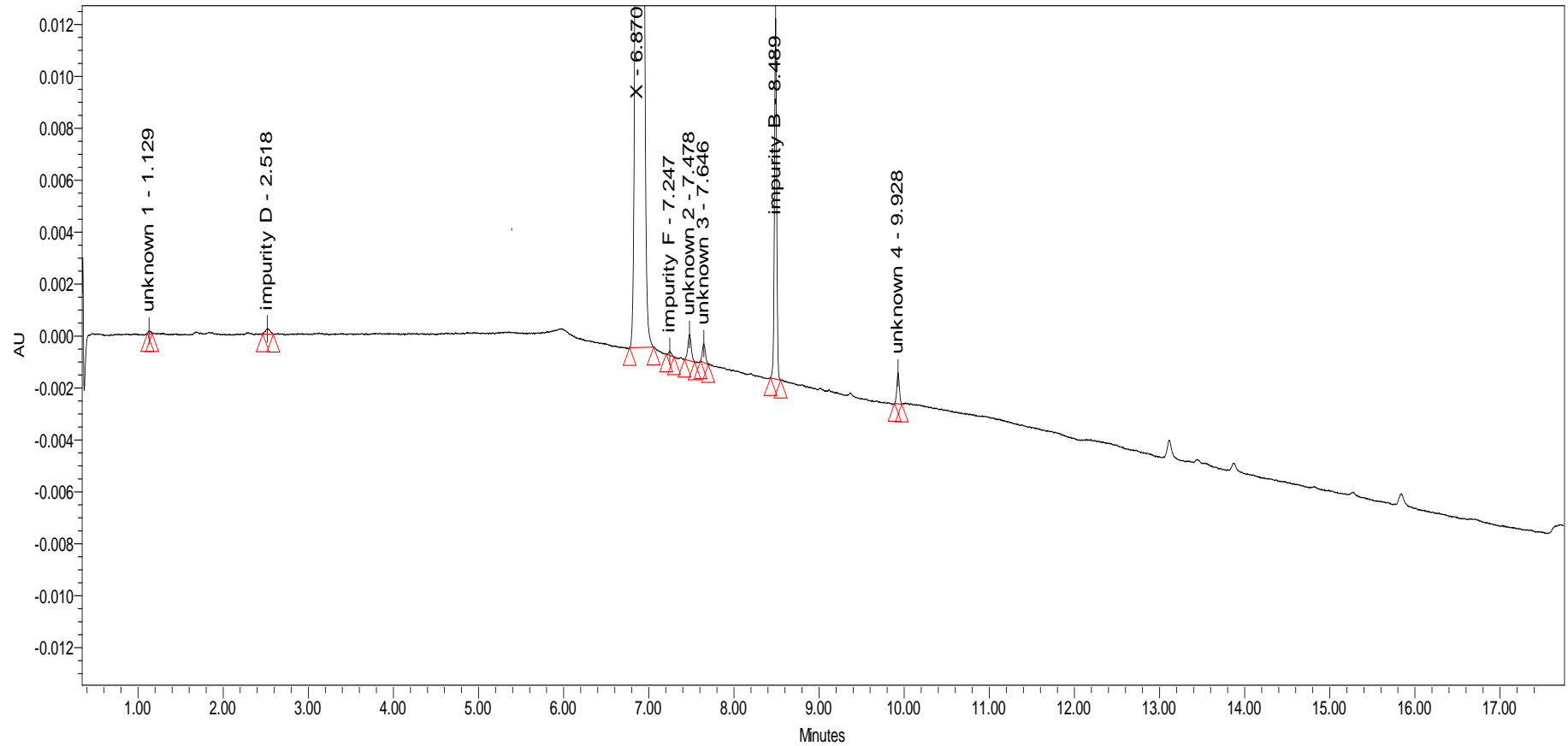

## Appendix

### Appendix 4: Sample with 0.2% impurities and blank – Zoomed on area of interest

Appendix 4 shows a chromatogram of impurities of X. Each pure impurity is diluted separately and spiked in the formulation to obtain a concentration of 0.2 % (100 %= API concentration) and directly injected in the UPLC.

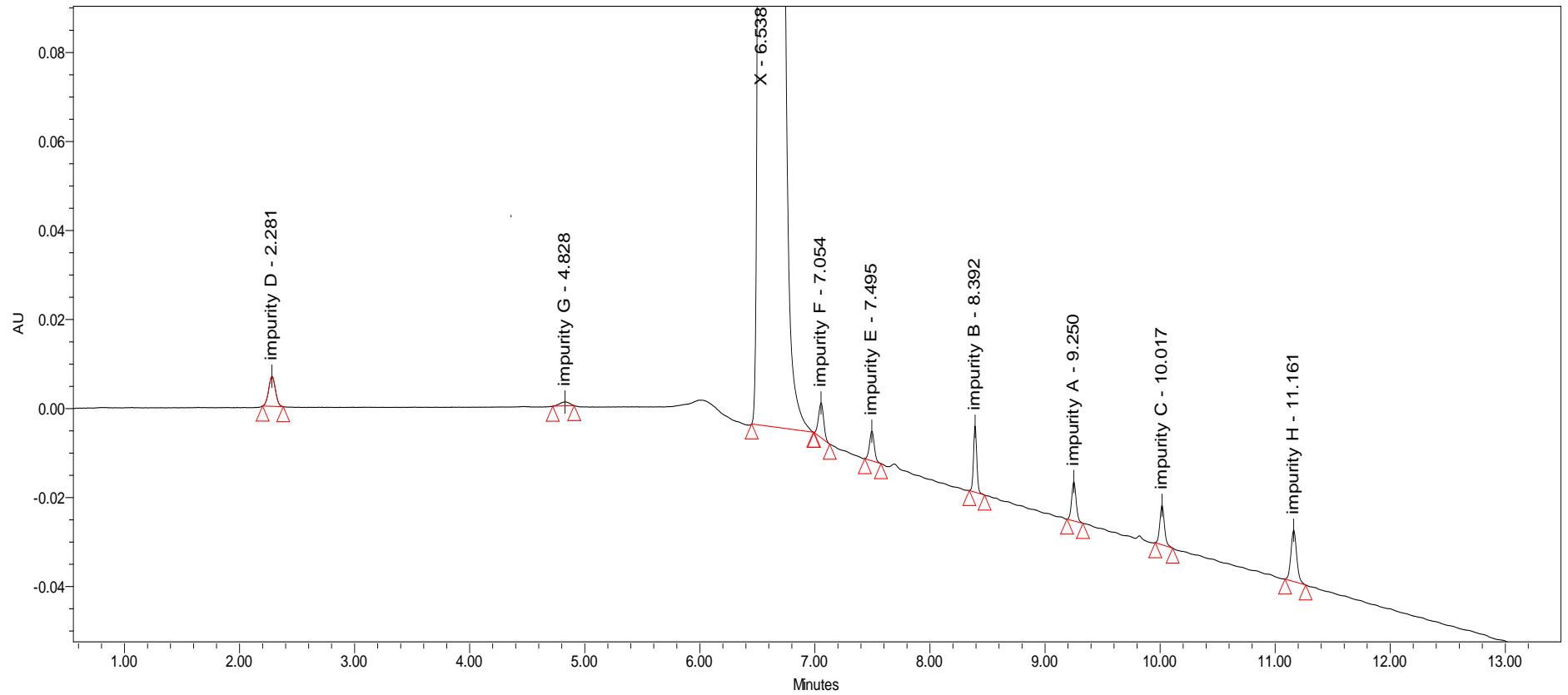

Appendix

**Appendix 5: Filtration results: comparison between sample before filtration (AV) and sample after filtration (T0)**

As data are really close between AV and T0 samples and within specifications, we can't see any significant impact of filtration on X injections:

pH		
lot number	AV	T0
X 2 mg/mL pH-4.0	4.00	4.09
X 2 mg/mL pH 5.0	5.03	5.30
X 10 mg/mL pH 4.0	4.00	4.04
X 10 mg/mL pH 5.0	5.01	5.13

Osmolality (mOSM)		
lot number	AV	T0
X 2 mg/mL pH 4.0	290	334*
X 2 mg/mL pH 5.0	287	288
X 10 mg/mL pH 4.0	308	310
X 10 mg/mL pH 5.0	298	294

\*This osmolality data seems aberrant as it was not found back in filtration studies done afterwards. This is a phenomenon isolate to watch.

UPLC API assay (pic 283 nm) (mg/mL)								
lot number	AV				T0			
	E1	E2	Mean	% Label Claim	E1	E2	Mean	% Label Claim
<b>MPH 10-05-96- 4.0</b>	2.013	2.009	<b>2.01</b>	<b>100.6 %</b>	2.005	2.006	<b>2.01</b>	<b>100.3 %</b>
<b>MPH 10-05-96- 5.0</b>	1.986	1.990	<b>1.99</b>	<b>99.4 %</b>	1.986	1.986	<b>1.99</b>	<b>99.3 %</b>
<b>MPH 10-05-97- 4.0</b>	9.978	9.938	<b>9.96</b>	<b>99.6 %</b>	10.070	10.06 6	<b>10.07</b>	<b>100.7 %</b>
<b>MPH 10-05-97- 5.0</b>	10.09 1	10.10 2	<b>10.10</b>	<b>101.0 %</b>	10.058	10.07 9	<b>10.07</b>	<b>100.7 %</b>

Appendix

Impurities assay (area %)								
lot number	Impurity		AV			T0		
	Name	RRT	E1	E2	Mean	E1	E2	Mean
			(% area)	(% area)	(% area)	(% area)	(% area)	(% area)
X 10 mg/mL pH 4.0	Impurity A	1.41	0.04	0.05	<b>0.05</b>	0.04	0.04	<b>0.04</b>
	Impurity B	1.28	0.01	0.01	<b>0.01</b>	0.01	0.01	<b>0.01</b>
	Impurity C							
	Impurity D	0.36	0.04	0.05	<b>0.05</b>	0.04	0.03	<b>0.04</b>
	Impurity E							
	Impurity F	1.08	0.09	0.13	<b>0.11</b>	0.12	0.11	<b>0.12</b>
	Impurity G		ND	ND	<b>ND</b>	ND	ND	<b>ND</b>
	Impurity H		ND	ND	<b>ND</b>	ND	ND	<b>ND</b>
	Impurity of impurity G		ND	ND	<b>ND</b>	ND	ND	<b>ND</b>
	Unknown	1.50	0.02	0.02	<b>0.02</b>	0.02	0.02	<b>0.02</b>
	<b>Total Impurities</b>			0.16	0.21	<b>0.19</b>	0.23	0.21
X 10 mg/mL pH 5,0	Impurity A	1.41	0.04	0.04	<b>0.04</b>	0.05	0.04	<b>0.05</b>
	Impurity B	1.24	0.01	0.01	<b>0.01</b>	0.01	0.01	<b>0.01</b>
	Impurity C							
	Impurity D	0.36	0.04	0.03	<b>0.04</b>	0.04	0.04	<b>0.04</b>
	Impurity E							
	Impurity F	1.08	0.11	0.10	<b>0.11</b>	0.11	0.10	<b>0.11</b>
	Impurity G	ND	ND	ND	<b>ND</b>	ND	ND	<b>ND</b>
	Impurity H	ND	ND	ND	<b>ND</b>	ND	ND	<b>ND</b>
	Impurity of impurity G	ND	ND	ND	<b>ND</b>	ND	ND	<b>ND</b>
	Unknown	1.50	0.02	0.02	<b>0.02</b>	0.01	0.02	<b>0.02</b>
	<b>Total Impurities</b>			0.20	0.18	<b>0.19</b>	0.22	0.21

## Appendix

Impurities assay (area %)								
lot number	Impurity		AV			T0		
	Name	RRT	E1	E2	Mean	E1	E2	Mean
			(% area)	(% area)	(% area)	(% area)	(% area)	(% area)
<b>X 10 mg/mL pH 4.0</b>	Impurity A	1.42	0.05	0.05	<b>0.05</b>	0.04	0.05	<b>0.05</b>
	Impurity B	1.28	0.02	0.02	<b>0.02</b>	0.02	0.01	<b>0.02</b>
	Impurity C							
	Impurity D	0.36	0.03	0.04	<b>0.04</b>	0.04	0.04	<b>0.04</b>
	Impurity E							
	Impurity F	1.078	0.17	0.02	<b>0.10</b>	0.07	0.08	<b>0.08</b>
	Impurity G		ND	ND	<b>ND</b>	ND	ND	<b>ND</b>
	Impurity H		ND	ND	<b>ND</b>	ND	ND	<b>ND</b>
	Impurity of impurity G		ND	ND	<b>ND</b>	ND	ND	<b>ND</b>
	Unknown	1.50	0.02	0.02	<b>0.02</b>	0.02	0.02	<b>0.02</b>
	<b>Total Impurities</b>			0.27	0.13	<b>0.20</b>	0.19	0.20
<b>X 10 m g/mL pH 5.0</b>	Impurity A	1.42	0.05	0.05	<b>0.05</b>	0.05	0.05	<b>0.05</b>
	Impurity B	1.28	0.02	0.01	<b>0.02</b>	0.02	0.01	<b>0.02</b>
	Impurity C							
	Impurity D	0.36	0.04	0.04	<b>0.04</b>	0.04	0.04	<b>0.04</b>
	Impurity E							
	Impurity F	1.08	0.17	0.18	<b>0.18</b>	0.17	0.15	<b>0.16</b>
	Impurity G		ND	ND	<b>ND</b>	ND	ND	<b>ND</b>
	Impurity H		ND	ND	<b>ND</b>	ND	ND	<b>ND</b>
	Impurity of impurity G		ND	ND	<b>ND</b>	ND	ND	<b>ND</b>
	Unknown	1.50	0.02	0.02	<b>0.02</b>	0.02	0.02	<b>0.02</b>
	<b>Total impurities</b>			0.28	0.28	<b>0.28</b>	0.30	0.27



# SERMENT DES APOTHICAIRES

Faculté de Pharmacie de Grenoble



## Serment des Apothicaire

Je jure, en présence des maîtres de la faculté, des conseillers de l'ordre des pharmaciens et de mes condisciples :

D'honorer ceux qui m'ont instruit dans les préceptes de mon art et de leur témoigner ma reconnaissance en restant fidèle à leur enseignement.

D'exercer, dans l'intérêt de la santé publique, ma profession avec conscience et de respecter non seulement la législation en vigueur, mais aussi les règles de l'honneur, de la probité et du désintéressement.

De ne jamais oublier ma responsabilité et mes devoirs envers le malade et sa dignité humaine ; en aucun cas je ne consentirai à utiliser mes connaissances et mon état pour corrompre les mœurs et favoriser des actes criminels.

Que les hommes m'accordent leur estime si je suis fidèle à mes promesses. Que je sois couvert d'opprobres et méprisé de mes confrères si j'y manque.



## **TITRE : IMPLEMENTATION ET OPTIMISATION D'ETUDES DE DEGRADATION FORCEE EN PRE-DEVELOPPEMENT POUR L'AMELIORATION DU SCREENING DES FORMULATIONS**

---

Le travail présenté ici est axé sur l'implémentation d'une méthode rapide et facile à appliquer pour réunir des données concrètes sur la sensibilité des principes actifs et la stabilité des formulations face à différentes conditions drastiques de pH, chaleur, lumière ou taux d'oxygène par exemple.

La première partie présente le contexte dans lequel s'inscrit l'étude et explique de façon plus précise la mission. Le principal avantage des études de dégradations forcées en pré-développement, sera un gain de temps et d'argent. Ces tests permettront de connaître précocement les conditions de stabilité optimales d'un principe actif en solution et aideront donc à la détermination des paramètres finaux de formulation.

Dans la seconde partie, une étude bibliographique est menée afin de rechercher quelles conditions peuvent influencer la sensibilité des molécules, quels paramètres de la formulation peuvent être testés facilement en laboratoire et s'il existe des tests, déjà pratiqués. Une recherche bibliographique sur la sensibilité du premier actif, nommé X, choisi pour subir les tests de dégradation forcée lors de son développement sera aussi développée.

La troisième partie décrit les études menées sur X à l'échelle du laboratoire. Ces études ont permis d'aider à la détermination du pH optimum de stabilité de la formulation. L'avantage de l'inertage pour protéger ce principe actif sensible à l'oxydation a aussi été montré. Les interactions possibles entre la formulation et les constituants de la seringue ont aussi été étudiées ainsi que la capacité pour la formulation de subir des cycles d'autoclavage sans engendrer de dégradations excessives. La reproductibilité de la méthode a été évaluée et une extrapolation des résultats pour estimer le comportement de la formulation à 25°C a été calculée.

---

**MOTS CLEFS :** Dégradation forcées, Inertage, Formulation d'injectable, Autoclavage, Procédé, Mise en stabilité

---

## **TITLE: IMPLEMENTATION AND OPTIMIZATION OF PRE-DEVELOPMENT FORCED DEGRADATION STUDIES FOR FORMULATIONS SCREENING IMPROVEMENT**

---

The thesis presented here mainly hinged on the implementation of the most predictive and rapid way to determine formulation factors influencing sensitivity of drugs when exposed to several stress conditions: pH variation, heat, light exposure, oxidation for example, in order to produce stable injectable solutions in syringes.

The first part deals with the context in which this study was held and explains more precisely the mission. The more important advantage of pre-development forced degradation studies will be a time and cost benefit. Those tests will permit to determine earlier the optimal molecule stability conditions when put in solution and will help in the setting of final formulation parameters avoiding the wait for pre-stability results.

The second part describes the bibliographic study held to find which kind of condition can influence molecules sensitivity, what kind of parameters can easily be tested and what the existing tests are. The research of stability information concerning the drug, named X, chosen to be developed by the team will also be developed.

The third part develops studies performed in the formulation laboratory on the molecule X. Those studies were helpful to set the optimum formulation stability pH, to highlight the advantages of the inerting process to protect this molecule sensitive to oxidation, the possible interactions between formulation and syringes components and finally the formulation capability to undergo autoclaving cycles without excessive degradation. Repeatability of this method was evaluated and an extrapolation was calculated to estimate the formulation behavior at 25°C.

---

**KEY WORDS:** Forced degradation, Inerting, Injectable formulations, Autoclaving, Process, Storage.