



HAL
open science

Optimizing data storage for MapReduce applications in the Azure Clouds

Radu Tudoran

► **To cite this version:**

Radu Tudoran. Optimizing data storage for MapReduce applications in the Azure Clouds. Performance [cs.PF]. 2011. dumas-00636818

HAL Id: dumas-00636818

<https://dumas.ccsd.cnrs.fr/dumas-00636818>

Submitted on 28 Oct 2011

HAL is a multi-disciplinary open access archive for the deposit and dissemination of scientific research documents, whether they are published or not. The documents may come from teaching and research institutions in France or abroad, or from public or private research centers.

L'archive ouverte pluridisciplinaire **HAL**, est destinée au dépôt et à la diffusion de documents scientifiques de niveau recherche, publiés ou non, émanant des établissements d'enseignement et de recherche français ou étrangers, des laboratoires publics ou privés.

Optimizing data storage for MapReduce applications in the Azure Clouds

Report

Radu Marius Tudoran
Radu.Tudoran@irisa.fr

Supervisors: **Gabriel Antoniu, Luc Bougé, Alexandru Costan**
{Gabriel.Antoniu,Luc.Bouge,Alexandru.Costan}@irisa.fr

ENS de Cachan, IFSIC, IRISA, KerData-Team

June 2011

Abstract

In this report we address the problem of data management in clouds for the MapReduce programming model. In order to improve the performance of data-intensive applications, we designed a distributed file system deployed on the computation nodes of public clouds. This approach exploits the data locality principle by moving the data close to the computation. The read performance increases up to 2 times and the write performance increases up to 5 times, compared to the traditional remote storage techniques used in public clouds. Encouraged by these results, we developed a customized MapReduce platform, relying on our distributed file system, and optimized it for data-intensive applications. We illustrate the benefits of our approach using a joint genetics and neuroimaging application for studying the variability between individuals, based on univariate data analysis. By adjusting the design of our MapReduce platform to meet the requirements of this application, we were able to reduce its computation time by up to 4 times.

Keywords: Cloud Computing, Cloud Storage, MapReduce, PaaS, Data-Intensive Applications, Neuroimaging

Contents

1	Introduction	2
1.1	Cloud computing	2
1.2	A taxonomy of clouds	2
1.3	Public clouds and their challenges	4
1.4	Data-intensive applications on public clouds	5
2	Cloud storage for data-intensive applications	6
2.1	Motivation	6
2.2	State-of-the-art	7
2.2.1	MapReduce model	7
2.2.2	Azure model	10
3	Application study: Joint neuroimaging and genetic analysis	12
3.1	Description of the application	13
3.2	Analysis of data patterns	14
3.3	Analysis of computation	14
4	Contribution I: A DFS for Azure Clouds	15
4.1	Motivation	15
4.2	BlobSeer	16
4.3	A-BlobSeer	17
4.4	Autonomic properties	20
5	Contribution II: MapReduce in Azure	21
5.1	Context	21
5.2	AMR	22
5.3	A-BMR	24
6	Contribution III: Iterative MapReduce	26
6.1	Motivation	27
6.2	Iterative A-BMR	28
7	Evaluation	29
7.1	Contribution I: A-BlobSeer	30
7.2	Contribution II: A-BMR	32
7.3	Contribution III: Iterative A-BMR	35
8	Future Work	36
9	Conclusions	37

1 Introduction

The amount of data that is processed today is extremely large and more and more applications can be classified as data-intensive. The spectrum of such applications is very wide, ranging from governmental and commercial statistics, climate modeling, cosmology, genetics, bio-informatics, high-energy physics [29] to commercial ones. With the emergence of the recent infrastructures like cloud computing platforms, achieving highly efficient data management is a critical challenge. The overall application performance is highly dependent on the properties of the data management service. The purpose of this work is to explore new ways in which the execution of data-intensive applications in public clouds can be optimized.

1.1 Cloud computing

Cloud computing is animated by the idea of just using the infrastructure without managing it. Companies like Microsoft, Amazon, Google or Yahoo! have transposed this to industry. Cloud computing allows developers to concentrate on the business value rather on the starting budget. The clients of commercial clouds rent computing power (virtual machines) or storage space (virtual space) dynamically, according to the needs of their business. One of the accepted definitions for this concept is the following:

Clouds are a large pool of easily usable and accessible virtualized resources ... dynamically reconfigured to adjust to a variable load (scale), allowing ... an optimum resource utilization. This pool of resources is typically exploited by a pay-per-use model ... by means of customized SLAs [36].

According to this definition, a user of the cloud pays only the price for the needed resources at a certain and is able to scale **on demand** the resources according to the load. Cloud computing has appeared as an application-driven paradigm governed by business rules (i.e. "converting *capital expenses* to *operating expenses*" (CapEx to OpEx), or, for capturing the economic benefits, we can use the "pay as you go" syntagm [13]).

According to Buyya et al. [14],

Cloud computing promises reliable services delivered through next-generation data centers that are built on compute and storage virtualization technologies.

1.2 A taxonomy of clouds

With respect to the ways clouds can be used, the "de facto" consensus achieved led to the definition of 3 major exploitation levels: *Infrastructure as a Service* (IaaS), *Platform as a Service* (PaaS) and *Software as a Service* (SaaS) [13, 30, 36]. They can be conceptually viewed in Figure 1. The particularities of these will be highlighted and exemplified.

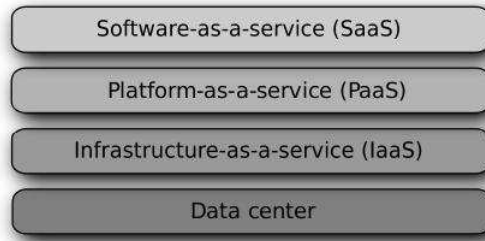

Figure 1: Cloud layers [30]

IaaS-Infrastructure as a Service. It offers a large set of computing resources (computation power or storage capacity) [30, 36], offering a simple on-line interface through which the infrastructure can be used. The users receive an account for logging to the front end and for launching multiple VM instances on the cloud. The infrastructure is exploited by means of virtualization, being highly dynamic and allowing the creation of ad-hoc systems on demand. Instead of buying servers, disks or networking equipment, cloud consumers rent and customize virtual machine images. Fees are charged in general, on a utility basis that reflects the amount of raw resources used: storage space-hour, bandwidth, aggregated CPU cycles consumed, etc. [30]. The most successful cloud systems at IaaS level are: Amazon EC2 [2], Nimbus [9], OpenNebula [11, 34], Eucalyptus [3, 32].

PaaS-Platform as a Service. It offers the possibility to exploit clouds in a different manner than using the virtualized infrastructure. Users can directly use a software platform, the requested hardware being provided transparently [36]. As it can be intuited, it is constructed on top of IaaS, providing a higher level of programming and freeing the customer from configuring VMs. A common way to develop applications at this level is to comply with specific roles, like in the case of **MapReduce** or **Azure**. These models will be detailed in section 2.2. The developers program at a higher level, concentrating only on the code for the applications that will run inside the cloud, possibly conformed to a specific architecture (e.g. Web Role and Worker Role for Azure) or/and on the data, which is stored through simple methods (e.g. HTTP requests). MapReduce [19] with its open implementation, called Hadoop [6], has recently gained a lot in popularity. The model consists in providing only 2 functions: Map and Reduce and the platform is responsible for everything else (data flow, launching the workers, etc.) In addition, Microsoft also offers Dryad [23], which has the same programming principles as MapReduce, but is more general. The additional features provided, allow more complex data flows and compositions between the workers.

SaaS-Software as a Service. It is the highest level at which clouds can be used by the customers. Notorious examples of such services are given next. Google offers Google Docs [4], where users can store their documents *out there* and are able to access them from any place. Microsoft Live Services [8] with Live.com is a set of personal Internet services and software designed to bring together in one place all of the relationships, information and interests people care about most, like mail, account, messenger, office etc.. Other players in the market like Amazon Web Services [2] or salesforce.com concentrate mostly on E-commerce. These become more and more popular, being addressed to all types of users, relieving them from

installing software, updates or patches [30]. In general a simple web browser is enough for accessing these softwares, as they can be reached from any location based on an ID.

Others. As the popularity of cloud grows, new types of exploitation appear besides the 3 mentioned above. Microsoft Azure [7] has successfully deployed its SQL Database into the Azure cloud. The major advantage is that it can be used identically as a normal database, having all the benefits of the cloud. They refer to it, as DataBase as a Service *DaaS* [17, 22], but more common Data as a Service is used. The SaaS concept can even be extended to the notion of Models as a Service (*MaaS*) where semantic annotations and ontologies are used to compose computational models and execute them as a conceptual whole [28]. If the current trends holds, new such concepts will continue to appear, but as it can be expected, they can be integrated in one of the three main categories, as DaaS could be considered as part of the PaaS, or MaaS from SaaS.

Let us notice that there are no strict borders between the layers. Since they are built on top of each other, the functionality can be easily enriched to reach an upper level. As an example an IaaS system with MPI configured could be easily proposed as a PaaS infrastructure.

1.3 Public clouds and their challenges

Public clouds describes the traditional main-stream sense of cloud computing, whereby resources are dynamically provisioned on a fine-grained, self-service basis over the Internet from an off-site third-party provider who bills on a fine-grained utility computing basis. In addition to the resources, the providers also offers guarantees like security and privacy and the possibility to scale the system (rent nodes) with no constraints. However, cloud computing still has some issues that must be overcome. The nature of these challenges could be expressed as:

Data management. It still needs a lot of work. Currently there is no *concurrency* at IaaS level or there is a very simple mechanism at PaaS level [22]. Complex applications with high concurrency can suffer or even cannot benefit from the cloud technology until better scheme for concurrency are delivered. There are limitations on the *size of the objects* that can be stored [2, 7], which can create some complications in the development process. The *fine-grain access* is another issue since, for example, IaaS provides just simple mechanisms like get and put for managing the data, and these operations cannot access just small parts.

Computational. The cloud ecosystem is heterogeneous [34] and this is reflected at several levels. The diverse experience of various cloud costumers starts with the network connection that the cloud has, which can be either regular or high-performance. If we refer to mitigating the applications between clouds, the problem of compatibility also rises. The need of moving between clouds, contrasts with the lack of standards regarding the deployment of VMs [34, 28]. But there are efforts regarding this issue [28], for instance the Open Geospatial Consortium [10] has created an annual process between the major stakeholders for developing such standards.

Security issues. In general, there are simple password mechanisms for identification, but more secured methods for authentication have been developed [12]. Recent studies have shown that a limit of the potential damage in case of an attack would be needed

(e.g. fine-grained delegation or limits on the traffic [33]). Another issue concerns the total trust that the clients must have in the cloud owner regarding their data. A security measure can be the encryption of data stored inside the clouds. The encryption can be the solution also for legal constraints, like data confidentiality.

Programing models. These imposed when using cloud technology could also create drawbacks. Referring to the imposed architectures like Web Role and Worker Role in Azure [17], not all applications can comply to them. Moreover, the stateless feature imposed by a load-balancer (distributes the requests among nodes) creates difficulties for existing REST (representational state transfer) applications, which are mostly statefull to mitigate into clouds. Issues regarding MapReduce programs refer to data location awareness, since the efficiency depends on the placement of the mappers close to the data.

1.4 Data-intensive applications on public clouds

In general, the data-intensive applications are found at IaaS and PaaS levels. It makes sense, since from the point of view of the user the SaaS level delivers a full product, everything being transparent for the customer.

At IaaS level, clients typically run a distributed application using a set of VMs encapsulating it, running under certain restrictions, according to some agreements made with the providers. Direct access to local storage space on the physical machine is usually denied: clients are instead provided with a specialized storage service that they can access through a specific API. The application and the environment in which they run have to be configured according to the particularities of the infrastructure.

At PaaS level, the clients provide the application that complies with the software platform that is offered. In addition to a remote storage that is offered by the providers, specialized file systems have been designed, such as HDFS, the default storage layer of Hadoop's MapReduce framework [6] (detailed in sections 2.2).

Although clouds are by definition governed by business rules, not only business applications are meant to be run inside it. Besides commercial use, clouds are very interesting also for scientific applications. Powerful scientific workflows started to be run in different cloud platforms and in addition there are efforts to migrate the MapReduce paradigm in public clouds. As an overview of what must be provided for scientific applications, we can mention [33]:

Data Durability. - Raw data that is lost can add additional costs, since a new computation will be needed to recompute it, so it should be durable.

Data Availability. - Since application can imply co-allocation of expensive resources, data should be present when needed.

Data Usability. - The customer should not concentrate on how to get their data, but rather on the logic of the applications.

Data Security. - Science applications often share data between multiple parties or institutions, so the providers must both protect data and allow complex sharing mechanisms

There are several studies that aim to analyze the advantages of cloud computing for scientific computation [25]. Juve et al. [25] have carried the analysis with 3 different types of

workflows, from astronomy, seismology and bioinformatics, showing encouraging results. However, the various studies like this one share some common views about the requirements of the applications that should be provided in the future in clouds. Depending on the access pattern, they highlight the utility of *caching mechanisms* and *data locality* that can decrease the costs [33]. Other issues refer to *fine-grained access* [33] or *concurrency* [22] since there is a lack of support for such attributes. As a conclusion, for scientific workflows in clouds we can say that the road is open, and as time passes and clouds will mature, we will see more and more such applications running in clouds, lured by the mirage of infinite power and storage [25].

2 Cloud storage for data-intensive applications

Cloud computing offers both computation and storage capacity *on demand*. However, the existing solutions from the cloud ecosystem, do not always provide answers for all needs. A particular case of application that we are interested in are the data-intensive applications, which have as main requirement the need for efficient data transfer. In order to satisfy this requirement, the computation platform in which the application is executed must use an appropriate storage backend which will permit efficient data manipulation. This section will present the motivation for this work, which focuses in providing solutions for these types of applications and as well the state-of-the-art for this topic.

2.1 Motivation

Recently, the MapReduce programming model, proposed by Google [19], has become more and more popular, gaining in popularity also due to the open source implementation called Hadoop [6] supported by Yahoo! [26].

There are ongoing efforts for improving and optimizing Hadoop. Common directions use data-locality, buffering and dedicated file systems [31, 35]. The Hadoop implementation, described in section 2.2.1, is used in open source clouds like OpenNebula [11] or Nimbus [9]. Such clouds, along with the Hadoop environment, are usually deployed in private clouds or on dedicated infrastructures like Grid5000 [5], and are less used in public (commercial) clouds. However, public clouds offer additional guaranties and features over the private clouds; hence a public customized and optimized MapReduce framework for such clouds would be useful.

There exists however, 2 possibilities to have a MapReduce framework in a public cloud.

The first option is to rent infrastructure from a public cloud and to deploy Hadoop. Taking into account the fact that the infrastructure of a public cloud is usually abstracted from users, some optimizations like data locality or in some cases a dedicated file system cannot always be supported.

The second possibility is to use directly a MapReduce web service like the one offered by Amazon [1], but this limits greatly the customizations and optimizations that could be done for specific applications.

Neither of these two possibilities covers all features that we target: to *run in public clouds*, to be *customized*, to have an *efficient storage backend*, to be *scalable at runtime* and in the same time

to inherit the properties guaranteed by the cloud providers.

Another programming model present at PaaS level is the one proposed by Microsoft in Azure cloud, detailed in section 2.2.2, that relies on *web roles* and *worker roles*. This programming model, limited to Azure, offers important guarantees like automatic recovery of a role in case of failure, privacy, confidentiality and security of data and the application. Such guarantees are essential when we deal with applications that process sensitive data.

It is interesting to study how these 2 PaaS programming models can be mapped in order to benefit from all their properties. The MapReduce approach has a uniform flow of data (input data is fed to mappers and their intermediate results will represent the input of the reducers which will generate the final outputs), the user being required to provide just the code of the 2 functions. The roles offered by Azure represent a more general model. The user has more freedom in establishing the data flows between entities, although most commonly the model is used as a master (web roles) - worker (worker roles). However, the model does not have the automatic orchestration as in the case of MapReduce.

We propose to implement a MapReduce framework starting from the roles offered by Azure. Our system targets to provide all traditional Hadoop properties, enhanced with improved fault tolerance mechanisms, optimized storage backend and support for runtime scaling, while remaining non-intrusive. A new feature for public clouds will be to have a dedicated distributed file system to be used by the MapReduce framework, which will allow better data manipulation than the alternative of using remote storage.

The context motivating this work is the collaboration between Microsoft and INRIA, within the A-Brain (AzureBrain) project, which aims to join neuroimaging and genetic analysis, detailed in section 3. The amount of data involved in this application is very large (terabytes of data for each simulation) and this data is sensitive, since it consists of medical records. Hence the underlying framework must have a very efficient data management enhanced with guarantees for privacy and security of data. Taking into account that the study performs statistical analysis, a large amount of runs are required in order to provide a satisfactory confidence level, thus parallelizing the simulation becomes critical. An efficient MapReduce framework with an optimized storage backend is needed.

2.2 State-of-the-art

This section will describe the state-of-the-art for the main programming models present at PaaS level. In section 2.2.1 we describe the MapReduce concept and its open source implementation called Hadoop. Section 2.2.2 will detail the programming model proposed by Microsoft in Azure cloud, based on *roles*. Both concepts will be analyzed from the point of view of the computational model and of the storage model.

2.2.1 MapReduce model

Although the MapReduce framework was proposed by Google [19], Hadoop [6, 37] became the reference MapReduce framework, being an open source implementation, supported by Yahoo! [26] and Amazon [1].

Computation Model: Mapper and Reducer The MapReduce programming model consists, from a user's point of view, in writing 2 functions: *the map* and *the reduce*. The map function *processes key/value pairs to generate a set of intermediate key/value pairs* [19], while the reduce function *merges all intermediate values associated with the same intermediate key* [19]. In Figure 2 the conceptual architecture of this programming model is illustrated.

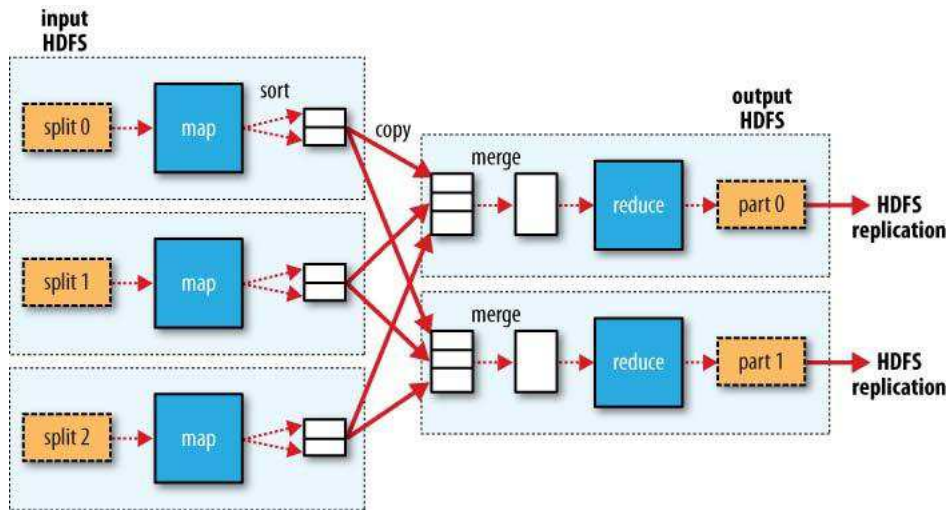

Figure 2: MapReduce data flow with multiple reduce tasks [37]

As it can be observed, the MapReduce model is simple and yet efficient. A specified number of workers (mappers) can run in parallel to do the job, while in the second stage, the reducers will combine the intermediate results produced in stage 1. The model has a uniform flow of data, which is read from the storage system by the mappers, each reading the data specific to its task, processing and finally writing the intermediate data. The reducers will take the data meant for them (a hash function is generally used to strip data between reducers), combine it, and generate the final output. Generally a user will provide the 2 functions to the framework and will select/provide the input data.

Usually, the data to be processed is uploaded in the system before the actual computation. Depending on the storage system, which will be detailed next, a specific API is used. For example a small program is written to take the data from somewhere (local or remote location) and to write it into the storage system by using the appropriate interface (API). In many cases this is a one time operation, so few efforts are made to make it efficient, although that the way data is stripped can have a major impact. For example, Hadoop will try to place the mapper as close as possible to the data (same node, same rack) to reduce the reading time. The striping is generally let in the responsibility of the storage system. The final data is read in the same way: a client application is constructed to interact through the API with the storage to retrieve the data.

The Hadoop architecture is presented in Figure 3. A client stores the initial data and submits the job that wants to be processed (number of mappers/reducers). The job tracker is in charge of contacting the nodes in order to start the mappers and the

reducers and to provide the initial data. It can reach each node through the help of a task tracker which is an agent that runs in each node. The policy to execute the jobs takes into account data placement in order to reduce the reading time. The framework tries to bring the computation as close as possible to the data. This is done through the help of *data locality*, meaning that the underlying storage signals to the job tracker its location (rack, cluster). Another optimization refers to data buffering. Data is brought in advance and buffered, hence the mappers and reducers are able to have any grain access, although data is manipulated in chunks of 64 MB.

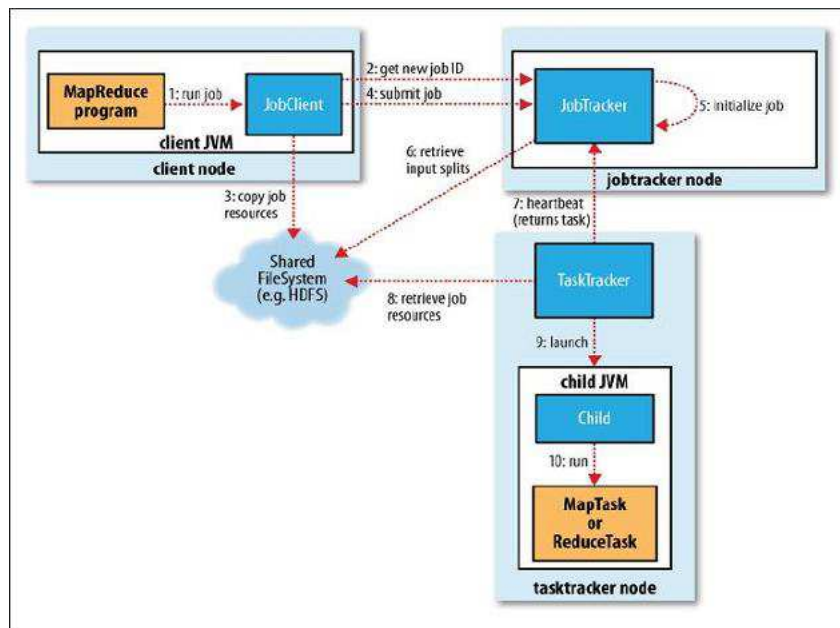

Figure 3: Hadoop Architecture [37]

Storage Model The MapReduce framework is constructed on top of a storage system that allows concurrent access from different nodes to the data. As Hadoop represents the state of the art for such frameworks, a description of the possible storage backends will be provided next:

Object storage The Amazon S3 (Simple Storage Service) [2, 33] has emerged as a *de facto* standard in manipulating data, Hadoop offering the possibility to use it as a storage system. The API to interact with it is rather basic and simply allows to put and get data at a specified location (the object sizes is up to 5TB). It does not offer adequate support for global data sharing under heavy concurrency. The Hadoop framework performs data striping in order to process larger amounts of data more efficient. Objects can be retrieved independently through the HTTP protocol from any location. By using a remote storage as S3, Hadoop loses the ability to place the computation as close as possible to the data, as in the case when a dedicated file system would be used.

A dedicated file system HDFS (Hadoop Distributed File System) is the default storage layer of Hadoop's MapReduce framework. The need to design specialized file

systems was motivated by the requirements of data-intensive distributed applications in terms of performance and scalability. In HDFS, data is typically stored using massive files that are concurrently accessed by Hadoop processes that run the map and reduce functions. HDFS has however some difficulties in sustaining a high throughput in case of concurrent reads to the same file [29, 35], while concurrent writes are not possible. The general architecture of HDFS is presented in Figure 4. As it can be seen there is a central component in charge of the meta-data, and multiple data nodes, where data is placed. From the point of view of fault tolerance, as in all DFS, replication of data is used to recover from possible node failures. The default replica number is 3. Hadoop uses the computation nodes (see Figure 3) also as storage nodes for HDFS, being able in this way to take advantage of data locality.

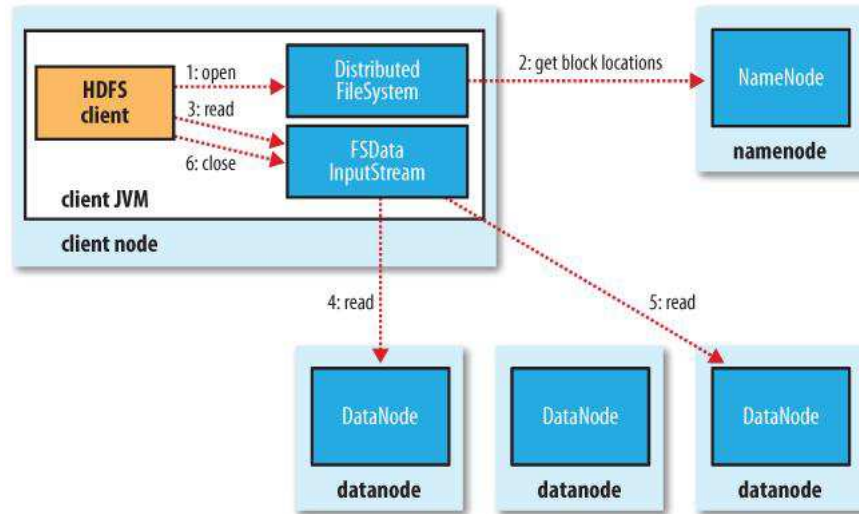

Figure 4: HDFS architecture [37]

2.2.2 Azure model

Microsoft has opened new directions with the release of its PaaS cloud called Azure [7]. The computation and storage model proposed are slightly different than the ones presented before. Instead of the MapReduce paradigm they propose roles (web and worker roles), while for the storage they offer blobs, tables and queues.

Computation Model: Web Role and Worker Role The general architecture for the computation model is presented in Figure 5. Each computation node rented in Azure has a Windows Server 2008 OS installed, and will execute an application with a worker or web role. The web roles are primarily destined to interact with outside requests (coming as HTTP requests) and to delegate the work to the workers, which will be returned as a result to the client. This default usage behavior is similar to a master-worker model. In order to balance the load among the web roles, the Azure cloud provides a default load balancer. All roles are identical, and in the default usage there is no distinction between them [17]. The cloud guarantees the requested number of nodes. It communicates with each node through the agent, and in case of a failure the machine will be

restarted.

Unlike the MapReduce model, in which the data flow is uniform, in Azure this is not restricted. Despite the fact that the normal usage presented would assume a flow of data from web role to the worker role and back, it is actually possible to orchestrate any flows of data between any entities. Thus, this model trades the ease to develop for a large freedom in constructing applications. In addition Azure offers a more advanced fault tolerance mechanism, since it is not only resistant to nodes failures, but reestablishes (restarts) the nodes. Another important property that is missing from Hadoop is the elasticity. Nodes can be added/removed without shutting down the overall application, which allows also a more flexible scalability.

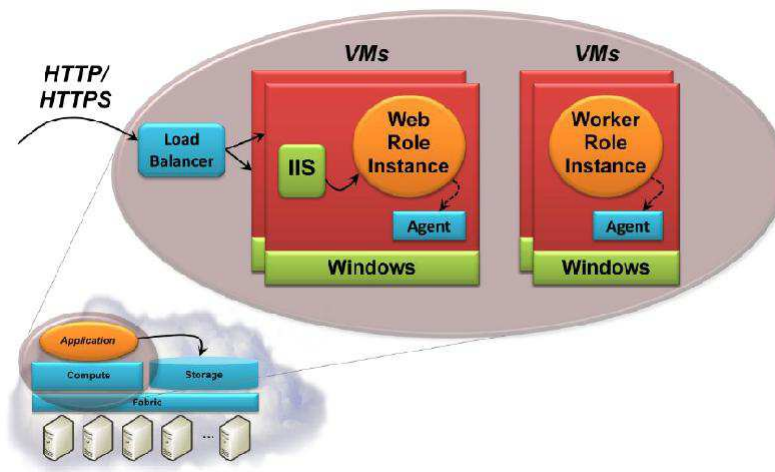

Figure 5: Azure computation model [17]

Storage Model Azure offers 3 types of storages that can be seen in Figure 6. Azure blobs are used for storing large amounts of unstructured data, the tables are used for storing structure data that require a fine grain access and finally the queues are used for communication between computation nodes. Data manipulation in all storage types is performed using HTTP. The storage mechanism provided by Azure use different nodes for storing data than for computation.

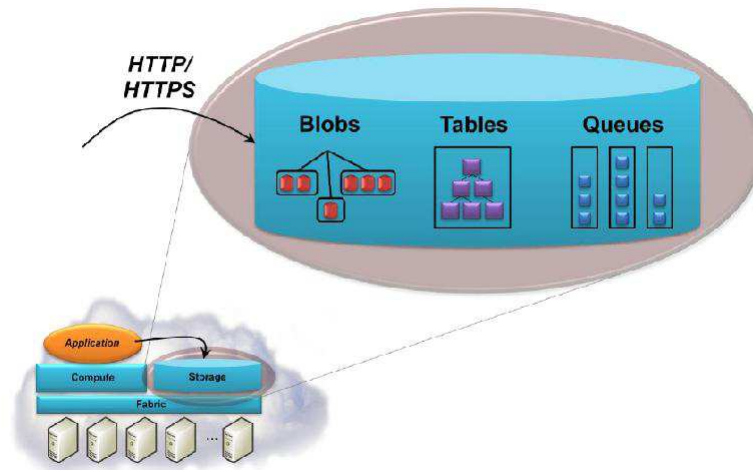

Figure 6: Azure storage model [17]

Azure blobs represent the mechanism to store large amounts of data. The maximum size of a blob is 50GB, but each user can have multiple blobs. The blobs can be grouped for a better management in structures called containers. Concurrent writes are not supported and in case of concurrent commits of uploaded data, the first commit succeed, while the rest of data corresponding to the failed commits will be deleted. The data written to a blob is secured and always available, Azure guaranteeing reliability.

Azure tables allow fine grained access to structured data. Unlike tables in relational databases, they do not enforce a fixed schema. An entry in a table is composed of records, each record having the type of the data and the data itself. There is no support for concurrency, in case of concurrent commits, only the first one will succeed. Consistency is ensured through atomic transaction in one table, but not provided between tables.

Azure queues are used for passing small messages (up to 8KB) between roles. They are fault tolerant, so a message written in a queue will be read at some point, but there is no guaranty about delivery order. A dequeued message is not deleted, but only hidden for a certain amount of time. If the role has finished processing the message it can explicitly deleted it, otherwise, the message will reappear and will be process by another role. Hence the queues offer a reliable and fast communication mechanism.

3 Application study: Joint neuroimaging and genetic analysis

Joint genetic and neuroimaging data analysis on large cohorts of subjects is a new approach used to assess and understand the variability that exists between individuals. This approach has remained poorly understood so far and brings forward very significant challenges, as progress in this field can open pioneering directions in biology and medicine. As both neuroimaging- and genetic-domain observations represent a huge amount of variables (of the order of 10^6), performing statistically rigorous analyses on such amounts of data repre-

sents a computational challenge that cannot be addressed with conventional computational techniques. We propose to apply our solutions for a MapReduce framework to address these computational challenges.

3.1 Description of the application

Imaging genetic studies the linking of functional MRI data with Single Nucleotide Polymorphisms (SNPs) data. In the genome dimension, genotyping DNA chips (the process of determining the genes of an individual by examining the individual’s DNA sequence), allow to record several hundred thousands values per subject, while in the imaging dimension an fMRI volume may contain 100k-1M voxels (volumetric picture element). Finding the brain and genome regions that may be involved in this link entails a huge number of hypotheses. A drastic correction of the statistical significance of pairwise relationships reduces crucially the sensitivity of statistical procedures that aims at detecting the association. It is therefore desirable to set up as sensitive techniques as possible to explore where in the brain and where in the genome a significant link can be detected, while correcting for family-wise multiple comparisons (controlling for false positive rate) [24].

Let (X, Y) be a joint neuroimaging dataset, i.e. a set Y of brain images after adequate pre-processing and a set X of genetic variables (single nucleotid polymorphisms SNPs and/or Copy Number Variants CNVs of genetic loci), acquired in the same population of S subjects. The dataset may also comprise a set Z of behavioural and demographic observations, such as psychological tests or age. In the tests performed this set is null.

X is assumed to comprise n_v variables, e.g. one for each location in the brain image domain, while Y comprises n_g variables; typically $n_v \sim 10^6$, $n_g \sim 10^6$; when available, Z contains typically less variables (of the order of 10^2). These variables cannot be considered as independent, as there exist serial correlations between consecutive SNPs or CNVs, and spatial correlation within neighboring spatial locations in brain images. The main problem that we want to address is the detection of statistically significant links between the sets X and Y . This can be performed using univariate testing, i.e. testing the statistical significance of the correlation or equivalent association measure of all (x, y) pairs for $(x, y) \in X \times Y$.

Univariate testing Let us consider a pair (x, y) of genetic and neuroimaging variables. x is a set of S values counting the number of alleles at a given location in the genome; y is some quantitative measure of brain activity. One possible model to relates these variables is (allelic dose model):

$$y = \mu + x\beta + z_c\beta_c + \epsilon \tag{1}$$

where μ is a constant, z_c a set of confound variables and β_c the corresponding parameters; β is the parameter to be inferred, that measures the amount of correlation between the variables of interest. β will be finally turned to a significance (p-value). Assuming that the only 3 values for x are $(0, 1, 2)$, an alternative model can be proposed:

$$y = \mu + \beta_0\mathbb{I}_{x=0} + \beta_1\mathbb{I}_{x=1} + \beta_2\mathbb{I}_{x=2} + z_c\beta_c + \epsilon' \tag{2}$$

where the parameters of interest are now the parameters $(\beta_0, \beta_1, \beta_2)$ that represent the response associated with levels of minor allele frequency. In short, regression analysis simply yields $n_v \times n_g$ p-values that represent the statistical significance of the association between neuroimaging and genetic variables. The difficult issue is that one needs to control the probability of making one false detection (family-wise error rate) or the false discovery rate (fdr) of the test. The ensuing correction drastically decreases the power of the analysis (using naive approaches, the significance of the results is merely reduced by a factor $n_v \times n_g$). However, it should be taken into account that the variables and the tests are non-independent. The most proper way to do so is to use a permutation procedure, in which the data of one block is reshuffled B times ($\approx 10^4$), and the p values obtained in the initial regression analysis are compared to those obtained in each of the B shuffles.

3.2 Analysis of data patterns

The initial data to be processed is given by a (X, Y) pair of a joint neuroimaging dataset. X represents a set of genetic variables. A variable has the dimension n_v , and there are n_s such variables, where n_s gives the number of subjects. Considering that for this univariate testing we assume only the set of $\{0,1,2\}$ values, we get X as a matrix containing one of these values. Y represents a set of brain images obtained with a functional MRI. Each image is divided into voxels and hence the set of values that forms each variable in Y represents a value for a region of the brain image. The number of variables is given by the number of subjects (n_s), thus forming a matrix of real values. After performing the necessary computations (the regression) the correlations between the two are obtained, giving a matrix of size $n_v \times n_g$ containing the p-values that represents the statistical significance of the association. Several regressions are performed, each giving a set of such correlations, and all these intermediate data must be stored in order to compare the values of each simulation in order to keep the most significant p-values. Thus taking into account that we have B matrices of doubles (8 bytes) of size $n_v \times n_g$, the amount of intermediate data that must be stored can reach (80 petabytes = $8 \text{ bytes} \times 10^4 \times 10^6 \times 10^6$).

3.3 Analysis of computation

As mentioned, several computations for the p-values must be performed on random shuffles of the initial data. This computation cannot be performed on standard equipment. However, the problem can be run in parallel because the computation can be slice along many dimensions (neuroimaging, genetic or permutations). For the case in which the parallelization is done with respect to permutation, each worker will take the same initial data, shuffle it and perform the regression between the 2 sets of data (X, Y) to obtain the correlation between them. The regression from computational point of view represents a series of matrix operations, having as result a matrix. All these operations can be simply considered as the job of a mapper if we parallelize the application with the MapReduce programming model. Hence each mapper will perform a regression and will generate as the intermediate output a matrix. The final step, which would be the reducer, must perform a filtering on these values. Therefore the reducer will take all intermediate data, merge them and select the values within a threshold interval. An example of parallelizing this application with respect to the MapReduce model is shown in Figure 7, with 3 mappers and 1 reducer. B shuffles must

be performed, thus the maximum parallelization factor for the map phase is B with respect to the parallelization according to the permutations. The reducer parallelization is not so direct. Basically we can launch more reducers that performs filters on intermediate data, in parallel, but all results should be combine to a unique one. We propose an iterative reduce phase and this will be detailed in section 6.

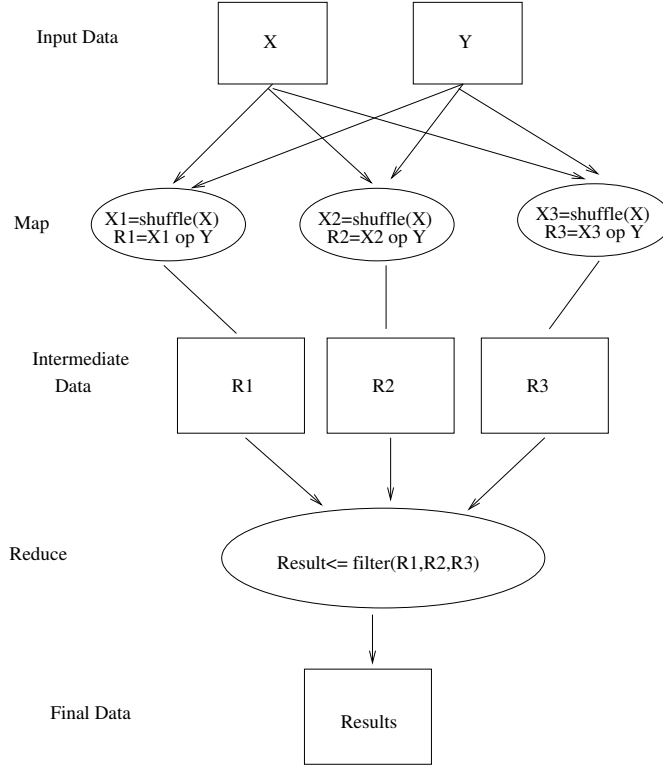

Figure 7: MapReduce Example of the neuroimaging and genetic application

4 Contribution I: A DFS for Azure Clouds

This contribution proposes to exploit the data locality principle in public clouds by providing a distributed file system (DFS) that will be run in the computation nodes. This section presents the challenges and the advantages to deploy the DFS in a public cloud. We first present the motivation and then introduce a distributed file system, BlobSeer [29, 30] which has proven to be highly efficient in cloud environments [31]. Finally we detail the enhancements developed for this system in order to meet the specific needs of Azure Cloud, along with the benefits obtained from this.

4.1 Motivation

The public clouds like Azure [7, 17] or Amazon EC2 (Elastic Compute Cloud) [2] offer storage services like Azure Blobs [15] for Azure or S3 [2, 33] for Amazon. These type of storages made up of data nodes are in remote locations with respect to the computation nodes. An existing API based on HTTP protocol permits any application, executed on a cloud com-

putation node or outside the cloud, to perform data operations (put/get). The benefits of using these storage systems are data security [12], easy access from anywhere and reliability [16, 22]. However, when it comes to data-intensive applications, like some of the scientific ones [25, 28, 33], the *distance* between computation nodes and data nodes affects the performance. Both Azure and Amazon offer the possibility to select the data centers in which data will be placed and this allows users to place the computation in the same center. However, the overall performance can be increased by moving data closer, in the same racks or perhaps on the same node.

The idea that we propose is to exploit the *data locality* principle by having the data and the computation in the same nodes of a public cloud. This approach trades data-availability with efficiency, a good tradeoff for scientific applications that are executed in the cloud, since the data, most often private, is not accessed by the general public. To our knowledge there are no DFSs that can be deployed in the computation nodes of public clouds like Azure. Our contribution fills this gap, offering an efficient solution for data-intensive applications.

Each virtual machine (node), in both Azure and Amazon clouds, has a local storage space varying from 160GB up to 2TB. This local storage can be used with no additional cost, but the major drawbacks are the fact that it is not persistent (in case of failures all data on it is lost) and is not accessible to the other nodes. Our solution overcomes these limitations and exploits these resources efficiently. It consists of a distributed file system that is deployed on all computational nodes and offers to the application running in each node the same view of a unique, shared file system. The DFS uses the local space on each node to store the data and offers the possibility to all nodes to access data from any other nodes. By placing the data on the local storage of the nodes, the data is as close as possible to the computation, thus applying the principle of data locality. Fault tolerance is addressed through replication: having several replicas ensure that even in case a node fails, the remaining nodes can still retrieve the remaining copies of the data. In addition to efficiency of data manipulation, another advantage relates to the cost. By using a DFS instead of the storage offered by cloud providers, the cost for storage and for the bandwidth traffic are eliminated. The contribution is a general solution that can be applied for any problem.

4.2 BlobSeer

BlobSeer [29] is a distributed file system that combines a set of principles in order to sustain the manipulation of large binary objects (BLOBs). It is centered around the idea of leveraging versioning for concurrent access to BLOBs in order to efficiently exploit data-level parallelism and sustain a high throughput despite massively parallel data access. Versioning enables efficient management for data-intensive applications by generating new BLOB snapshots in order to avoid inconsistency even in the case of concurrent read/writes. Such snapshots are performed atomically, simplifying the application development. In order to sustain a high throughput, which is highly needed for such applications, the Input/Output operations are done asynchronously.

A BLOB is composed of a sequence of chunks, using additional metadata to map subsequences of chunks, identified by *offset* and *size*, to the corresponding BLOB. Since such an object can have large sizes it would be inefficient and sometimes impossible to store it entirely in one place. Hence, the chunks are striped across the data nodes, allowing parallel

writes/reads. Their size has a major impact on the overall performance of the DFS and of the application that uses it. It should be chosen based on an analysis of the data access patterns and on simulations on the infrastructure on which it will be deployed. There is a tradeoff between the increase parallelism obtained from splitting the data for the computation into smaller work units and the costs of scheduling, initializing and synchronizing these work units in a distributed fashion. If the chunk size is too small, then computation nodes will need to fetch data from multiple chunks, making techniques such as scheduling the computation close to the data less efficient and having to pay for the communication overhead. On the other hand, selecting a chunk size that is too large may force multiple work units to access the same data chunks simultaneously, which limits the benefits of data distribution. Fault tolerance is achieved through replication. Each chunk will be replicated on several data nodes in order to ensure availability in case of failures. Replication is also used for the metadata in order to ensure availability.

BlobSeer is composed of several types of distributed intercommunicating entities. Figure 8 illustrates these entities and the interconnections between them. **Clients**, which in our case are the data-intensive applications, create, read, write and append data to/from BLOBs. The DFS supports a large number of concurrent clients which is mandatory in large scale processing. **Data (storage) providers** are the entities responsible to physically store the chunks. The **Provider manager** keeps information about the available space on the storage providers and schedules the placement of the incoming chunks. **Metadata providers** are responsible for storing the metadata that allows identifying the chunks that compose a snapshot version. The **Version manager** is in charge of the new snapshot version numbers for writes and appends and for publishing these snapshots for readers. It is done so as to offer the illusion of instant snapshot generation and to guaranty consistency.

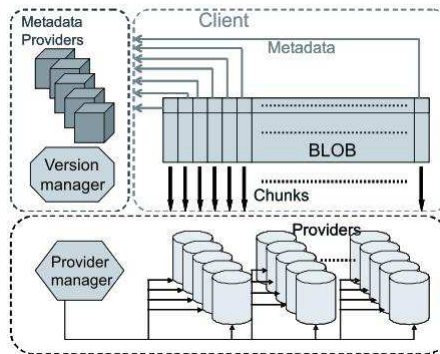

Figure 8: BlobSeer Architecture [29]

4.3 A-BlobSeer

Our contribution further referred to as A-BlobSeer, extends BlobSeer in order to create a DFS deployable on the computational nodes of a public cloud. The BlobSeer DFS has been adapted and augmented to meet the specific properties of the Azure cloud. By adapting and improving it, the new system offers all its basic properties and gains the features of the Azure cloud: automatic deployment, recovery of failed nodes, runtime scalability and privacy. Any type

of application like scientific applications as the one discussed in section 3 or commercial applications, can benefit from this contribution. The system offers the necessary means to combine all local storages of worker roles into an unique and uniform file system that can be used to communicate and to pass data between workers. In the same time, data manipulation is enhanced due to data locality.

For deploying BlobSeer in the worker roles of Azure, a new entity, which will be called *Initiator* was created, that permits the implementation of the proposed idea. Two major difficulties were encountered. The first one is specific to Azure roles (e.g. worker roles) and consists in the fact that from the point of view of the cloud, the roles are identical [17]. By identical nodes, Microsoft means the fact that all worker role instances will execute the same code. Hence the difficulty is given by the fact that we have to run/start the different entities of BlobSeer (virtual manager, provider manager, metadata providers and data providers) in different instances. Therefore, the Initiator, which is an agent that will run in each role, must make a distinction between instances in order to decide on which machine to start each BlobSeer entity. The second challenge comes from the transparency of clouds. A common assumption in public clouds is that the application will use the default communication mechanisms (e.g. Azure Queues or Amazons Simple Queue Service), so they wont need the IPs of the virtual machines. BlobSeer uses RPC (remote procedures calls - the method through which a process can execute a procedure/function in another address space) in order to communicate and to transmit data between entities. Because of this communication model, the Initiator must provide the configuration file with the addresses of all entities to each entity when this is started.

The Initiator is configured to be the first process started and executed when a virtual machine is started. It will access a special service provided by the cloud to ask for metadata about all instances, like IPs, ID etc.. Based on this information this agent is able to take the necessary decision in order to start the DFS. The decision mechanism was designed to allow customized policies for the DFS and for the application. The Initiator will create the configuration file for BlobSeer, and based on the ID of the virtual machine, it will start the appropriate entity on the local machine. It also takes into account how many entities of each type were specified in the policy. The policy also permits to specify if some nodes will be used just for running the application or just to run specific entities of BlobSeer. If specified, the Initiator is able to start different applications on each machine, which is a new feature that is not supported by default in Azure. Figure 9 offers an overview of the processes that are started in a virtual machine. Even if the policy allows precise customization, the whole process is automated and the user does not need to know any internal details about Azure.

A simple example of such a policy would be to start both the application and the entities of BlobSeer on all machines. For BlobSeer, the policy can specify 1 virtual manager, 1 provider manager and a ratio between metadata providers and data providers of $\frac{1}{5}$. Such a policy will permit to restore a virtual machine in case of a failure, and to restart on it the application and the entity of the DFS which was running before the failure. Another property that the overall system presents is the automatic scaling at runtime: for example by adding more computational nodes, the Initiator agent on that machine will assign the role based on the same policy and so the node can be integrated in the computation. The autonomic properties of the A-BlobSeer system are described in section 4.4.

As it can be seen in Figure 9, the application requires an API (Application Programming

Interface) in order to communicate with the DFS. This API provides simple methods to manipulate data (read, write, append etc.) in a transparent manner. As mentioned previously, BlobSeer uses RPC in order to communicate between its entities. The API that we have constructed, performs the necessary calls to the appropriate entities, in order to execute each function that is exposed to the application. Through this interface the application that runs in the cloud becomes the client of the DFS as presented in figure 8.

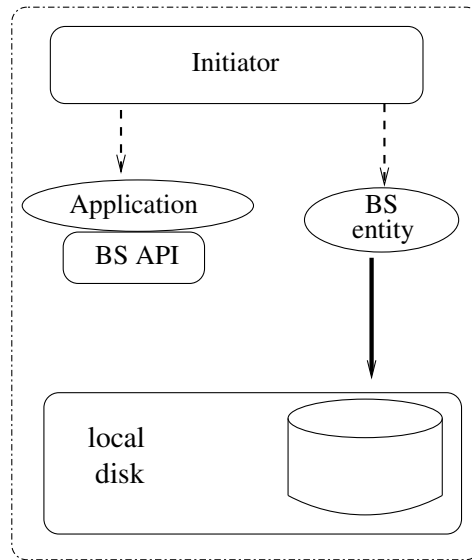

Figure 9: A-BlobSeer internal schema on a single node

The contribution of porting a DFS in the cloud is schematized in Figure 10. The A-BlobSeer approach will use the local space of the machines and expose it to the application as a unique and uniform file system. By taking advantage of the properties of the BlobSeer file system, this approach can sustain large number of concurrent clients both for reads and writes while providing efficiency and consistency of the data. This approach allows to take full advantage of the data locality principle even in public clouds, since data is brought as close as possible to the computation. The approach successfully combines the principle of data locality with the computation power of public clouds through the means of a distributed file system adapted for this specific infrastructure.

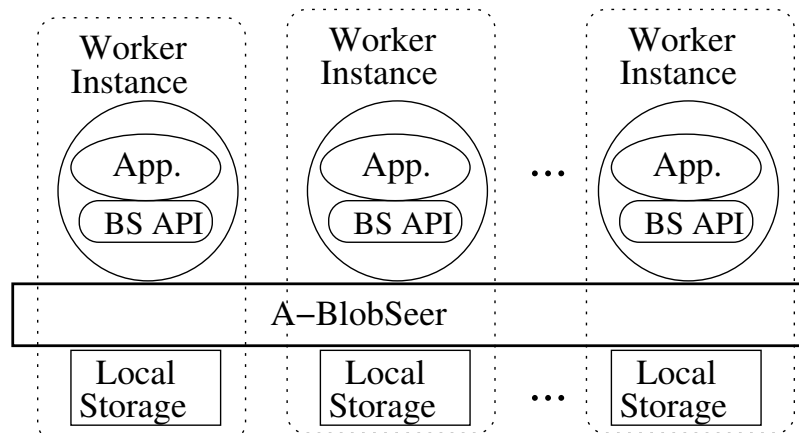

Figure 10: A-BlobSeer architecture

4.4 Autonomic properties

An important feature of the large scale systems is their support for autonomic properties in addition to their constant seeking for efficiency and performance. Considering their large scale, manual intervention to adjust, configure or protect them, cannot be applied. Out of the 4 major self* properties:

Self-configuration: the system follows high level policies

Self-optimization: the system seeks to improve their own performances

Self-healing: the system detects, diagnoses and repairs problems

Self-protection: the system defends against attacks and failures

defined by Kephart et al [27] for autonomic computing, A-BlobSeer provides two and it is designed such that it can be further improved to fulfill all of them.

Self configuration. It refers to the ability of a system to follow policies by automatically adjusting itself to them. As previously mentioned, the Initiator component follows a policy in order to initialize and start A-BlobSeer. It performs the needed configuration in an automatic fashion, complying with the customized rules in order to launch the environment. The system takes full advantage of the tools offered by the Azure cloud, which allow the application to be deployed automatically on all computational nodes. An archive containing the application is copied and launched on all machines. In our case, the Initiator will be the entity launched and along with it, all necessary components (executable files for the DFS, special libraries and the application/applications) will be moved on each virtual machine. Hence, the Initiator will be able to finalize the deployment step and continue with the configuration and finally with the launching of the A-BlobSeer processes.

Self configuring systems must not only behave autonomously during deployment, but also during the execution. A-BlobSeer exposes this property also while recovering from crashes. When a node fails, the Azure cloud re-deploys the previously mentioned archive on a new node. The Initiator will be launched on this new machine and will restore both the failed entity of the DFS and the application, by performing the initial configuration and by finding out what was the task of the failed instance. In a similar manner, the system is able to scale during runtime. Taking advantage of the feature offered by Azure, to ask for more or less compute nodes, A-BlobSeer is able to perform the demanded scaling.

In the case of scaling up, the new machine that is added to the system will be integrated into the A-BlobSeer environment by the Initiator, which will create the initial configuration for BlobSeer and will start a data provider and will launch the application according to the policy. Currently the Initiator component is designed to launch any type of BlobSeer entity, based on the policy, but BlobSeer supports only the adding of new data providers. With the future releases that will allow other entities to be added at runtime, the A-BlobSeer environment will be able to provide all its potential. In order to scale down, we make the same assumption as the underlying DFS: that the replication number of the data on the machine to be shut down is greater than one. If this assumption is violated, data losses can appear. In order to deal with data losses during scaling down or at the moment when the system is explicitly shut down, a self protection mechanism was designed and it is described below.

Self protection. It is the ability of the system to automatically defend against malicious attacks or cascading failures. In the case of cloud computing, the system is protected by malicious attacks because it is a closed system in a secured environment [12]. On the other hand we have identified two case in which failures can affect the system (scaling down, shut down request). DFSs use data replication in order to prevent data losses when failures happen. Multiple copies of data are created, on different machines which will provide, with a certain confidence level, data availability. The idea that we proposed was to use the local storage of each machine to store the data, but when the user wants to shut down the system, all machines are destroyed so all data is lost no mater how big the replication number was.

To address these problems, a self protection mechanism was designed. One or more agents, that run in the virtual machines backup all data from the local DFS into the persistent storage offered by the cloud, which in our case are the Azure Blobs. In order not to affect the performance of the application, the agents can be customized to run with a very low priority or just in the moments of inactivity of the main components (BlobSeer entities, application). Basically this agent will be a BlobSeer client that will use the API to copy the data into the remote storage. Since this large movement of data does not belong to the main computation flow, it will not affect the efficiency of the computation. By making backups of the data into a remote storage, no data will be lost when the system is turned off or when a node with data that had one as replication number is closed. In addition, a similar agent is design to do the opposite operation when the system is started. It will be launched by the Initiator component and will restore the system to the state previous to shut down (or a specified state). Hence, the A-BlobSeer will be able to recover even in case of major/total failures or requested shutdowns.

5 Contribution II: MapReduce in Azure

This section presents the challenges and the advantages of the MapReduce programming model in Azure clouds. Our proposed environment combines the strength of this parallel model with the efficiency of the previously presented contribution. The solution called A-BMR uses A-BlobSeer as a storage backend for the MapReduce environment destined for data-intensive applications

5.1 Context

The 2 PaaS programming models presented in section 2.2, *Azure roles* and *MapReduce* are not exclusive. As it will be shown, it is possible to deploy a MapReduce environment, which combines the properties of both models, in the Azure roles. This open and customizable platform, offers to anyone the possibility to adapt it with respect to the necessities of the application. Since the A-BMR is designed for a public cloud it benefits from all its advantages, like on-demand resources scaling, privacy and security. This contribution combines the idea of having a DFS in the computational nodes with the power and simplicity of the MapReduce model, taking advantage in the same time by all features offered by Azure cloud environment. Our major interest are the data-intensive applications and the work focuses on optimizing the data management for the platform. As presented in the previous sections, a run of MapReduce application has 2 read phases (the reading of the initial data by mappers

and the reading of the intermediate data by the reducers) and 2 write phases (the writing of the intermediate data by the mappers and the writing of the final results by the reducers). The data-intensive applications which are executed using this model, have as critical points these phases [25, 31]. By exploiting the idea of moving the data on the computation nodes the data manipulation phases are optimized.

Currently Azure cloud does not permit the deployment of Hadoop, since it does not provide a Java Virtual Machine and is not able to offer all configuration information and permissions in order to execute it. However, Microsoft has announced that they will provide in the future a service based on Hadoop to execute MapReduce applications. Microsoft has its own framework capable to execute MapReduce jobs, called Dryad [23]. Dryad is superior to MapReduce from the point of view of the workflows that can be executed. While in Hadoop the default flow is the one presented in Figure 7, Dryad can offer a large number of possibilities to define the flow of data between instances. The major disadvantage is the fact that currently Dryad can be executed just in Microsoft High Performance clusters and cannot be run in clouds. Hence, at this point there is nothing provided for the MapReduce programming model or for data-intensive applications by Microsoft and this represents another motivation for our work.

Gunarathne et al [20] have constructed a MapReduce framework called AMR (Azure MapReduce) for the Azure cloud, which will be detailed below. They are using Azure Blobs as storage backend for their platform, which does not benefit from data locality principle as A-BlobSeer proposes. Our framework, A-BMR, uses A-BlobSeer in order to exploit the available local storage space for a more efficient data manipulation and uses a simpler communication schema for the coordination among entities. Unlike Hadoop, our system is able to recover the failed nodes and offers runtime scalability.

5.2 AMR

AzureMapReduce (AMR) [20] is a distributed decentralized MapReduce runtime, developed for Azure cloud infrastructure. By using the public cloud infrastructure, AMR takes advantage of cloud features like scalability and high availability. In addition, the distributed nature of these services are guaranteed by the cloud provider to avoid single point of failures, bandwidth bottlenecks and management overhead [20]. The AMR implementation uses the Azure storages as follows: Azure Queues are used for map and reduce task scheduling, Azure BLOBs for storing input, output and intermediate data, Azure Tables for metadata storage and the computational worker roles for running the tasks. In the case of Google MapReduce [19] and Hadoop [37] there exists a central master node in charge with controlling the work flow, for which failures are assumed to be rare. Its task is to monitor the completion of the jobs and handle the task assignments. AMR implies a decentralized control model with no central control node, thus avoiding possible single point of failures. It uses global queues for scheduling and the tables for metadata storing. Another property that is inherited from Azure environment is the dynamic scalability up or down of the computing instances at runtime.

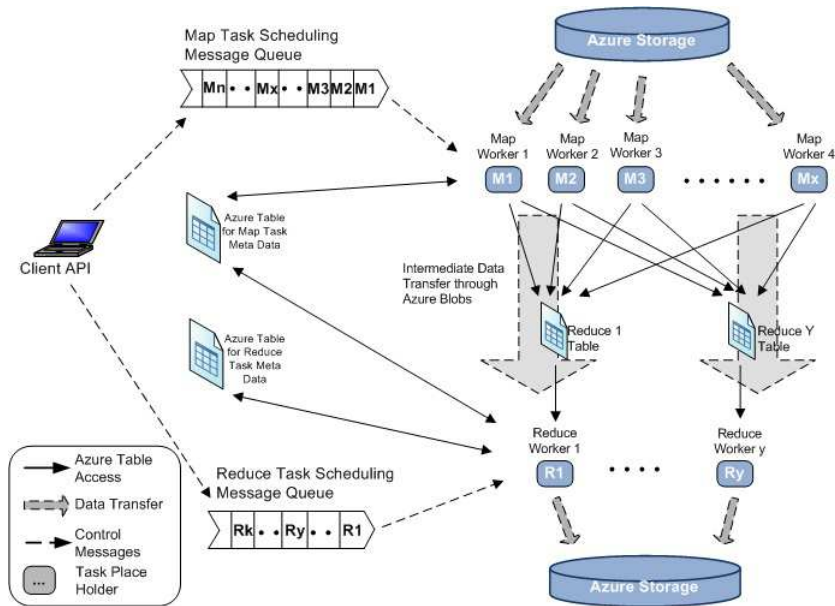

Figure 11: Azure Map Reduce architecture [20]

Figure 11 presents the AMR architecture. The **client** is responsible for submitting the map and reduce task to the system by providing the needed data for computing instances. The information manipulated by the client are the addresses of the initial data, the address locations in which intermediate data can be stored and where the final data should be placed. In addition, the client is responsible to create the Azure tables for the metadata needed by the framework and to diffused their addresses. The messages sent by the client towards mappers and reducers through the queues, contain the addresses of the table locations corresponding to this job and the job description.

The **map** instances are run in the worker roles provided by Azure. They represent a pool of workers that wait for messages from the client which would assign them jobs. They will read the metadata of that task from the corresponding Azure tables and based on this, they will download the initial data from Azure BLOBS. They will process it and upload the intermediate data back to Azure BLOBS. In order to complete the task they will write the metadata about the intermediate results into Azure tables, from where the reducers can retrieve it.

The **reduce** instances are similar to the mappers. They are a pool of workers that wait for tasks to be assign to them. Once a job description is retrieved by a reducer from the queue, it will start polling the tables in order to read the metadata about the intermediate data (this is written by mappers when they finish their jobs). When this information is available, the reducer will download the intermediate data from the addresses that are specified by the metadata. The reducer will start the processing when all the map tasks are completed and all the intermediate data destined for this reducer is downloaded. Finally, when the compute phase is finished, they will upload the final result and store in the Azure tables the corresponding metadata about it.

The advantages that the AMR framework presents are decentralized control, scalability and fault tolerance. However, the authors are mentioning the low performances of the storage layer on which their platform is constructed and they state that they are searching for more

efficient ways to perform data transfers [20]. Our idea to move the data in the computation nodes provides a solution for this problem, solving the inefficiency of data manipulation. The A-BMR platform that we have developed, and that will be detailed in the next subsection, provides an answer to this problem by applying the A-BlobSeer solution that we have proposed. In addition to this, our solution proposes a simpler communication schema for performing the scheduling and for metadata management, eliminating the need to use Azure tables.

5.3 A-BMR

A-BlobSeerMapReduce (A-BMR) platform is a decentralized framework design for Azure clouds, which is optimized for data-intensive applications. The design decisions had to consider the fact that cloud environments are more predisposed to failures than for example computing in clusters. Hence, fault tolerance was carefully considered and in order to obtain this property for the system, a platform with no single point of failure was constructed. Unlike AMR, our solution exploits data locality by using A-BlobSeer as a DFS deployed in the computational nodes. Data transfer, protection and confidentiality are enhanced by taking benefit from the fact that the local storage of the compute instances is used for data, instead of a remote storage. Our solution uses only Azure queues for scheduling, since there is no need to interact with Azure tables for metadata management as in the case of AMR. The queues are a reliable, scalable service design for small, short-lived transient messages adequate for job assignments. On the other hand, Azure Tables do not guarantee immediate availability of data, but rather guarantee eventual availability. From the computational point of view, the amount of time until data becomes available is a lost time (the workers are idle). Our system uses the metadata management provided by BlobSeer and allows us to send just small messages between entities, eliminating in this way the need to store additional information in Azure tables.

Figure 12 presents the architecture of our system. The **client** is an Azure Web Role through which the user can specify the parameters of the job he/she wants to submit. Based on this specifications, the appropriate scheduling messages for mappers and for reducers, are created and enqueued in the corresponding queues. The scheduling messages that are transmitted towards mappers or reducers are small, containing the ID of the mapper/reducer and some small information about the way data can be retrieved from A-BlobSeer. This information contains the blob ID, the size of data and the offset. As in the case of the other MapReduce frameworks like Hadoop or AMR, the initial data is supposed to be present in the storage system when the application is launched. Since the underlying DFS has an efficient striping policy, the influence of the way the initial data is written into the file system has minimum impact on the overall performance. This data can be simply uploaded in A-BlobSeer through a web interface provided by the client.

A-BlobSeer is used as a unique and uniform storage backend for the A-BMR platform. The reading of initial data and of the intermediate data and the writing of intermediate data and of the final data is performed in the local storage space of the computational nodes. This local storage is exposed as a whole for the application. A-BlobSeer supports concurrent read and writes, guaranteeing in the same time the consistency of the data. The only information needed by an application to access through the BS-API the data is the ID of the blob in which the data resides, the size of the data and the offset. By using the local storage space

which is available in the compute instance machines, not only that the efficiency of the data manipulation is increased, but also the cost to run a MapReduce application is decreased. The execution costs decrease because the local space is free, while for the remote storage we have to pay both for the actual storing and for the bandwidth to access it.

The **mappers** are deployed in Azure worker roles. Based on the parameters specified for the A-BlobSeer, a pool of mappers is created. They are regularly polling the scheduling queue in order to retrieve the messages with the job description submitted by the client. They will start reading the initial data through the BS-API provided by A-Blobseer and will run the job. After the processing phase they are writing the data in the DFS through the same API, and they create small messages for reducers containing the information about the intermediate data, which will be enqueued in the synchronization queue. Finally they will return to the pool of mappers waiting for new tasks.

The **reducers** are similar with the mappers, being also deployed in Azure worker roles and based on the customization parameters, a pool of reducers is created at deployment time. The reducers first poll the queue through which the client submits the jobs, and when a task is being assigned, the reducer which becomes in charge of it will start listening to the synchronization queue. It waits until at least one message is send from the mappers towards the reducer. It will dequeue the message and fetched the intermediate data. The data will be processed and then the reducer will move to the next intermediate data, which is destined for it and so on. Unlike AMR, our framework starts to process intermediate data as soon as some data is available in order not to keep idle the reducer until all mappers have finished. When all data was processed, the final result will be written in the A-BlobSeer. However, the framework can also be configured to wait for the completion of all map tasks before starting a reducer job. This feature is provided because there exists applications which require all data present in the reducers before starting the processing.

The **queues** are used as a scheduling mechanism by A-BMR. The Azure queues guarantee that a submitted message will not be lost, and will be eventually executed by a worker. Thus by implying them in the scheduling process our framework gain fault tolerance in case of unexpected crashes. There are 3 queues in A-BMR: the *Map Scheduling Queue* is used by the client to submit jobs towards mappers, the *Reduce Scheduling Queue* is used by the client to submit jobs towards reducer and the *Synchronization Queue* is used by the mappers to informed the reducers that intermediate data is available for processing.

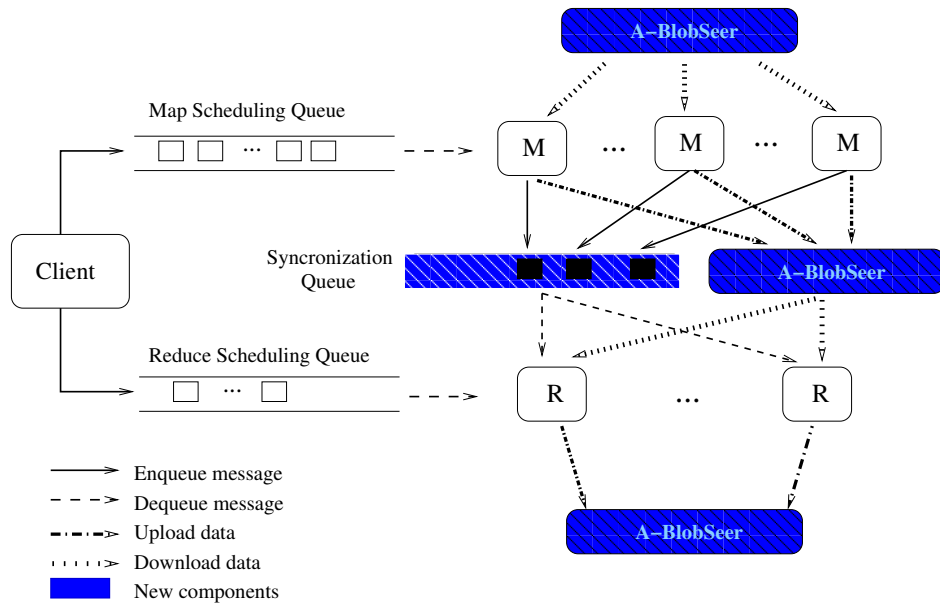

Figure 12: A-BMR architecture

Our framework takes advantage of the properties offered by Azure and by the DFS solution that we proposed (A-BlobSeer). A-BMR is a decentralized MapReduce framework with an optimized data manipulation layer which exploits data locality by using the free local storage present in computation nodes instead of the remote storage. It is a scalable framework, having the ability to scale on-demand at runtime and being fault tolerant. As it was described in the section in which A-BlobSeer was detailed, the Azure environment re-deploys the eventual failed nodes, and the A-BlobSeer environment is able to re-integrate these machines in the computation. Hadoop, which is the reference implementation for MapReduce, does not provide neither runtime scaling nor the node recovery as our system does. Data losses are prevented by the replication mechanisms used by the DFS, while for the tasks (the submitted jobs) we prevent losses through Azure queues. A message in the queue is guaranteed by Azure not to be lost. For the read (dequeued) messages that are executed by mappers/reducers the following mechanism prevents losses: a dequeued message is not actually deleted from the queue, being only hidden for a time period. During this amount of time, the mapper/reducer must finish the job and explicitly delete the message. In the eventuality that the computation node crashes before the job is finished, the message will not be deleted from the queue. Hence, it will reappear and will be executed by another worker. The system benefits from a simple yet efficient scheduling schema, that along with efficient data management layer offered by A-BlobSeer, makes A-BMR a very good solution for executing data-intensive application in public clouds.

6 Contribution III: Iterative MapReduce

MapReduce programming model is a simple, yet powerful model adequate for acyclic algorithms. However, there are several types of data-intensive applications that require several rounds of processing on the data in order to generate the final result. A possible approach is to create a pipeline of MapReduce, but this approach has proven to be less efficient than a

dedicated Iterative MapReduce platform [18]. This section presents how we can apply concepts from Iterative MapReduce for providing an optimized platform for applications based on univariate analysis.

6.1 Motivation

There exists iterative applications and algorithms that can be parallelized using the MapReduce programming model. Simply using the default implementations for MapReduce would not be enough. It was proposed [38] for such application to adopt an iterative MapReduce. Such a processing would imply that the *map* and the *reduce* phase are repeated a certain number of times. Hence the data flow in this case becomes: initial data goes to mappers, their results are feed to the reducers and the output of the reducers will be the input of the mappers. Such frameworks, which implement this idea, like Twiste4Azure [21], or Cloud-Cluster [18] introduce a new entity in addition to the mappers and reducers. The new entity, referred as Merger [21], is in charge with taking the decision if a new iterations is to be made or not.

Our case study application, the joint neuroimaging and genetic analysis, cannot benefit properly from such an iterative MapReduce framework. This application, and in general the data-intensive applications that use univariate analysis have a consistent map phase and a light reduce phase, which combines the intermediate data. However, it is important to keep in mind that the reduce phase has to combine all intermediate results and to output a single final result. A typical MapReduce run would give as many final results as the number of reducers. Somehow, this type of applications would require a single reducer.

Univariate analysis consists in performing the same computation on shuffles of the intermediate data and than to combine all these results. Since the number of scuffles can reach 10^4 , it is clearly that the combine phase of the method must be parallelized, otherwise it would become a bottleneck. One solution would be to use iterations, but the outputs of the reducers cannot be feedback to the mappers. However, these data could be feedback to reducers as intermediate data. This idea basically would mean that we would provide just an *iterative reduce phase*. To our knowledge, there is no MapReduce framework that proposes the iteration of just one of the phases of the process.

Motivated by this, we want to adapt and optimized the previously presented MapReduce platform for univariate analysis in order to enhance the performance of the simulation of our case study application. However, our intention is not to develop a complex system like Twiste4Azure [21] or IMapReduce [38] but to understand the capability of the cloud and of data manipulation in public clouds and how to apply its basic functionality to the problem of univariate analysis. In addition, we want to adapt the A-BMR platform for this type of data-intensive applications, by creating an iterative reduce phase. With respect to data manipulation, Twiste4Azure uses the remote Azure BLOB storage, being actually an extent of AMR framework. Because of this, as it was described previously in section 5, data manipulation remains an issue for Twiste4Azure. Our solution which is based on using the storage in the data nodes provides a more adequate way to handle data transfers.

6.2 Iterative A-BMR

As mention previously, this contribution adapts the A-BMR platform, by creating an iterative reduce phase, for a particular subset of data-intensive applications, the ones that imply an univariate analysis. Such applications have some particularities that can be used in order to optimize the computations. Firstly, they have a consistent initial computation phase that can easily be parallelized as a map phase. All the outputs of these computations must be combine into a singular final result which is another characteristic. This combination or filtering represents the reduce phase in a MapReduce model. The type of the output result is the same as the type of intermediate results. For example, if the intermediate data is a set of arrays, or matrices, then the final result will also be an array or a matrix. This is important, since it makes possible to feedback the output of the reducers to other reducers as intermediate data, thus creating an *iterative reduce phase*. The motivation to feedback the data is to parallelize the reduce phase. We need to iterate in the reduce phase until we have processed all the intermediate data (that come both from mappers or from previous reduce iterations) to a unique result.

In Figure 13 it is presented the schema for the optimization that we propose for this type of applications. As it has been stated, we need to provide the mechanisms that produce an iterative computation just for the reduce phase. Conceptually at the end of an iterations the reducer/reducers that were involved in that iteration, evaluate if another iteration is needed (i.e. *is this result the final unique one or not?*). In case another iteration is needed, the results will be feed as the input for the new reduce iterations, otherwise the result is written as the final result.

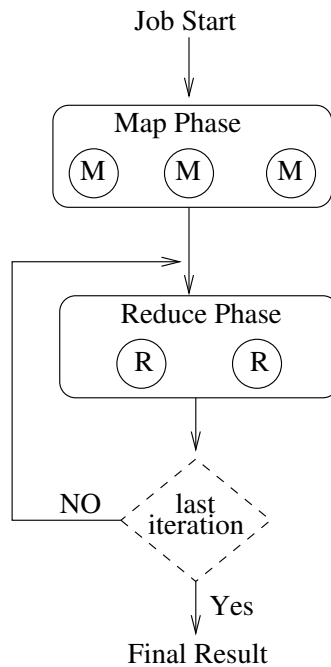

Figure 13: Univariate A-BMR schema

Although that the iterative MapReduce frameworks introduce a new entity which decides if the iteration process is over or not, in our platform no new entities are added. In Figure 13 we have represent with a dashed line the missing entity. We have chosen not to add

new instances in the framework in order to have a simple and efficient platform. In our solution, which provides a customized platform, the user specifies a number of reducers that should be implied in the first iteration phase. The intermediate data that comes from mappers is divided between all these workers (we aim to have same load on each reducer). For the second iteration phase, the maximum load for a reducer is the same as the maximum load for the first iteration phase. Based on this maximum load, the number of reducers that will be involved in the second phase will be computed and it will be smaller than the number of reducers for the previous iteration. This happens until we reach a phase in which one reducer is able to process all the intermediate data, without processing more than the allowed maximum load. The result of this reducer will be the single final result for the MapReduce application.

To illustrate this, assume a simple case with 8 mappers (hence 8 intermediate data that need to be reduce to 1 final result) and we specify that we want 4 reducers in the initial reduce phase. The maximum load allowed becomes $\frac{8}{4} = 2$. Hence each reducer will take 2 intermediate results and reduce to one. For the second step of the computation we have 4 intermediate data. The maximum load is 2, hence the number of reducers for this second phase is $\frac{4}{2} = 2$. The 2 reducers involved will produce 2 outputs. Hence the third and last phase will involve a reducer that takes the 2 outputs and produce the final result. Based on this algorithm and the parameters set by the user which starts the application, the appropriate number of reducers will be notified (appropriate messages with reduce tasks will be send - see Figure 12). Based on these messages the entire iterative scheduling is created and there is no need to add new entities.

We have tuned the MapReduce platform for the univariate applications by parallelizing the reduce phase and in the same time satisfying the requirement to have a single final result. It is expected that if we increase too much the number of reducers, the processing phase of each of them will become small compared to the IO phase (reading and writing the data) and will decrease the overall performance. Hence for each experiment setup (number of mappers, size of data) there exists a different optimal number of reducers that should be involved, for obtaining the best computation time. So far this optimum number was found by experimenting different configurations. However, as a future work we propose to automate this process by creating an evaluation function that will give the cost for the computation.

7 Evaluation

This section will present the validation and the evaluation for the 3 contributions. All tests were performed in the Azure public clouds. Azure has several sites across the globe, from which we have used for performing the tests the ones located in West Europe (Ireland) and North Europe (Denmark). Azure offers several types of virtual machines that are presented in Table 1. The experiments that will be presented next, were performed on 50 small virtual machines with 1 core per node. For the underlying DFS we used the following number of instances for its entities: 1 virtual manager, 1 provider manager, 10 metadata providers and 38 data providers. For the MapReduce platform we have deployed 1 mapper and 1 reducer in each computation node.

Virtual Machine Size	CPU Cores	Memory	Disk Space for Local Storage Resources
ExtraSmall	shared	768 MB	20 GB
Small	1	1.75 GB	225 GB
Medium	2	3.5 GB	490 GB
Large	4	7 GB	1000 GB
ExtraLarge	8	14 GB	2040 GB

Table 1: Azure virtual machines

7.1 Contribution I: A-BlobSeer

In order to validate the idea that we propose, regarding a DFS deployed on the computation nodes that exhibits the data locality property, a series of tests were performed. These tests compare the performances for reading and writing the data using this approach versus the remote storage. The tests were done using the configuration described previously. In addition, there is one node that performs reads and writes of random data. For performing these operations with A-BlobSeer system, the client used the API that was constructed for this, while for the remote storage, the Azure BLOBs, it used the provided API that is based on HTTP. The remote storage used, was located in the same data center with the application. If the storage is located in a different site than the one used for computation, the network latency between sites diminishes greatly the performances. There are 2 ways to place data in a data center: the normal way, when any data node from the selected location can be used, or a second method which involves creating *affinity groups*. This second method consists in an explicit request made to the Azure cloud to try to place the data in the nodes that are closed to the ones used for the computation. Hence, the number of nodes that can be used is smaller, but the latency between computation and data is reduced. The experiments tested both these methods.

The first set of experiments that are presented in Figures 14 (for time) and 15 (for throughput), measure the time to perform the read and write operations and the throughput for these operations. The A-BlobSeer approach provides a customized DFS. An important parameter, present in all DFSs, that can be configured is the `pageSize`. This gives the measure of data fragmentation. Since a DFS can store large amounts of data, the data is split into chunks, with a certain size (the `pageSize`) that are placed on different data nodes. This also permits a simple replication schema, since each chunk will be replicated on more than 1 node, increasing in this way the fault tolerance of the system. The size must be carefully chosen being a tradeoff between fine grain access and parallelism on one hand and metadata overhead on the other hand. A small size would allow fine grain access and a good parallelization since each chunk can be stored/retrieved in parallel by a client, but will involve storing more metadata about the chunks. A big size would imply a small amount of metadata about chunks but restricts the parallel read/write operations that could be done on multiple data providers. For the remote storage provided by Azure the `pageSize` is fixed to 4 MB which is illustrated in the two figures by the straight lines. The experiments vary the size of the `pageSize` for the A-BlobSeer in the set {32 KB, 64 KB, 1 MB, 2 MB, 4 MB, 8 MB} and keep the size of the manipulated data to 256 MB. The size of the data was chosen so that we can perform a single call to a read/write function.

It can be observed that the time to read/write the data for A-BlobSeer decreases up to a certain point when pageSize is increased, and the throughput for the 2 operations increases. Beyond 4 MB the performances slightly decreases for our system. The explanation is due to several factors: the tradeoff between metadata and parallelization reaches the optimum point for this amount of data and we also suspect that the Azure cloud is optimized for this size of the packets since it coincides with the one used for their remote storage. The write throughput is better with our approach for all tested values for the pageSize then the ones that use the remote storage. The read performances become superior to the remote ones only when the pageSize is over 2 MB. These tests are useful for future experiments since they offered the possibility to chose an appropriate value for the pageSize parameter: 4 MB.

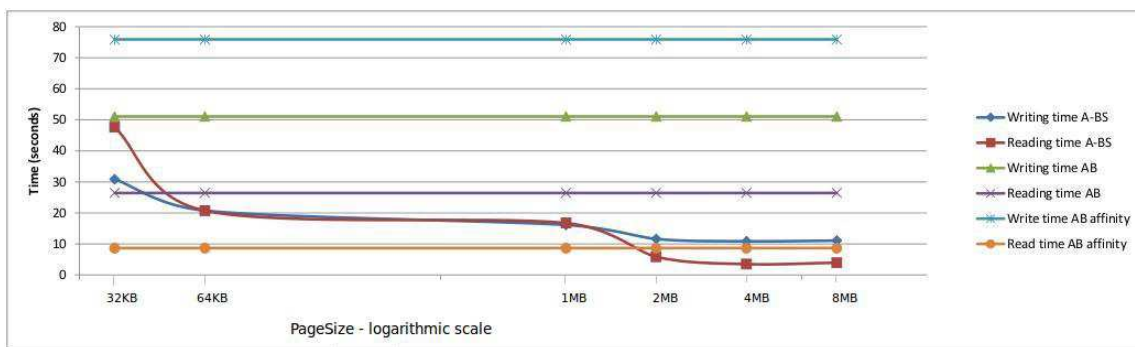

Figure 14: Time impact of varying the pageSize for A-BlobSeer

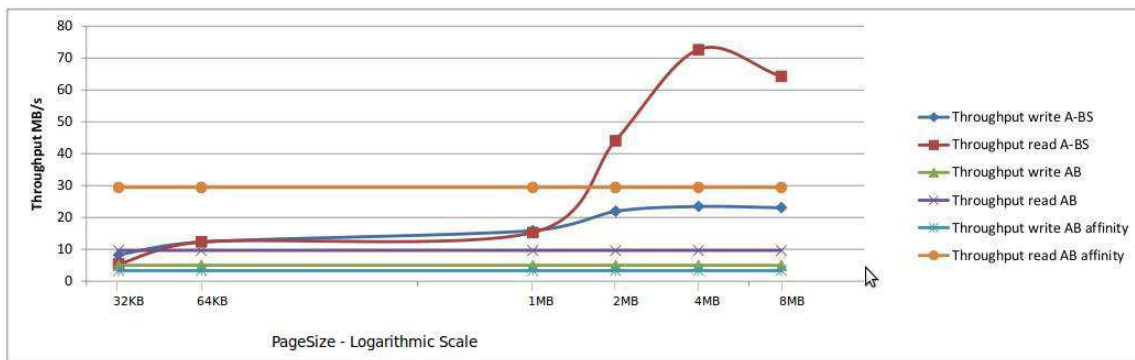

Figure 15: Throughput impact of varying the pageSize for A-BlobSeer

Once we were able to select an appropriate value for the pageSize (4 MB), a new set of experiments were conducted to compare our approach with the ones offered by the Azure clouds. The new set of tests, shown in Figures 16 (for time) and 17 (for throughput), vary the size of the data that is read/written to each of the storage systems. The data that is read/written is random data and is not related to a specific application. The size for the manipulated data varies from 64 MB to 512 MB. The reading or writing the data is done again with a single call to the corresponding API function.

The throughput provided by A-BlobSeer for both read and write operations is superior to the ones obtained by using the remote storage (Figure 17). It can be said that the throughput is almost the same (constant), no matter the size of the data, since the fluctuations that appear in the figure are more likely caused by the network. Because the experiments are performed in a public cloud there is no way to estimate the global usage of general resources like the

network. This set of experiments proves that the idea to use the local storage from the nodes instead of a remote storage is more efficient, thus it is worth to use it as a storage backend, especially for the platforms that run data-intensive applications.

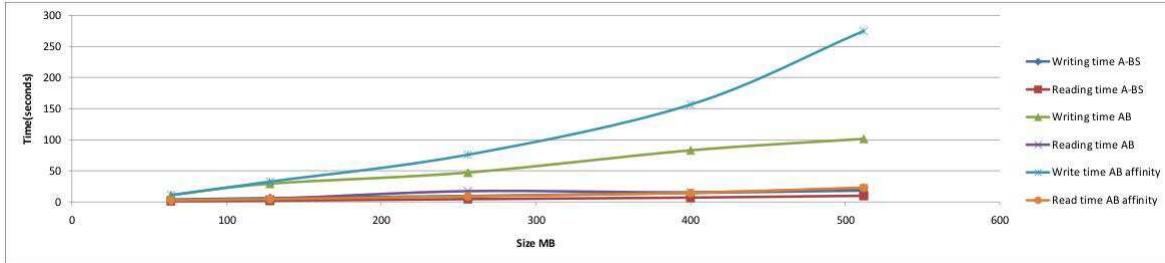

Figure 16: Time impact depending of data size for A-BlobSeer vs. Azure BLOBs

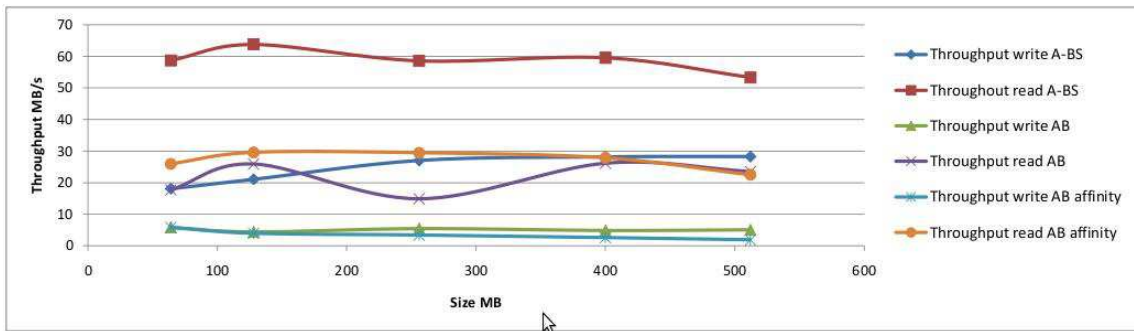

Figure 17: Throughput impact depending of data size for A-BlobSeer vs. Azure BLOBs

As it can be seen in all the previously presented figures, the performance of our system are superior to the ones of the two types of remote storage offered by Azure. The best read performance of the remote storage is the one offered by the affinity groups, since the latency between computation nodes and data nodes is small. On the other hand the performances of the write operation in case we use the affinity groups are lower then for the case when we use a normal write. This is due to the fact that less data nodes can be candidates for answering the write requests and the selection of these nodes (the ones that satisfy the condition to be close to our computation nodes) has an impact on the overall time of the operation. With our approach which use the principle of data locality the read performance increased up to 2 times and the write performance increased up to 5 times, proving the efficiency of the idea. These results have encourage us to develop a MapReduce platform that uses this storage system for data-intensive applications. The performances of this platform, A-BMR, are presented in the following section.

7.2 Contribution II: A-BMR

For validating the MapReduce platform that we propose for data-intensive applications we have compare our approach, A-BMR, with the general MapReduce framework, AMR. The experiments simulate the case study application that was described in section 3. For both deployments of the platforms, 50 computation nodes were used, allowing all map and reduce tasks to be executed in parallel. We have chosen to have all mappers and reducers working

in parallel in order to test the ability of the storage backend to support concurrent access. Each mapper or reducer iterates in an infinite loop waiting for tasks then executing it and going back to the wait state. All these iterations of a worker are identical from the point of view of the storage system.

For the first set of tests we have chosen a small number of mappers (5) and reducers (1) and we have successively increase the size of the initial data. The results of these experiments are presented in Figures 18 and 19. The initial data of the application is given by 2 matrices and we have increased one dimension of these matrices. Conceptually this means that more brain regions (voxels) and genes are analyzed. By modifying the initial data, both the intermediate data and the final data sizes are modified. The size of manipulated data for these experiments varies from 30 MB up to 2 GB.

In Figure 18 we present the total time for executing the application with the 2 platforms and the total time for a mapper to complete the job. It can be seen that with the A-BMR approach the obtained time values are better, benefiting by the data locality principle that is offered by A-BlobSeer. In Figure 19 the times for reading and writing the intermediate data are given. Our approach A-BMR uses the A-BlobSeer system as a storage backend while the AMR framework uses the remote storage. It can be seen that by increasing the size of the manipulated data, the times for writing become a bottleneck with the remote storage. On the other hand, our approach offers a better support for data transfers being more adequate for data-intensive applications.

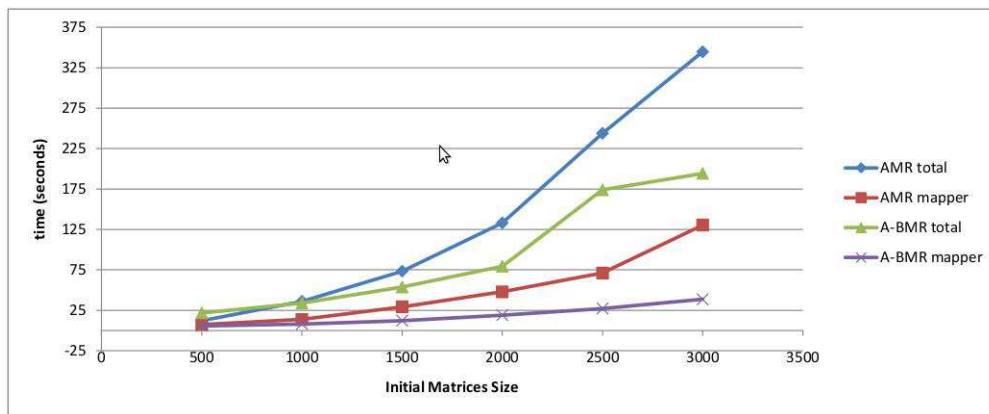

Figure 18: Total time of processing depending of size of initial data

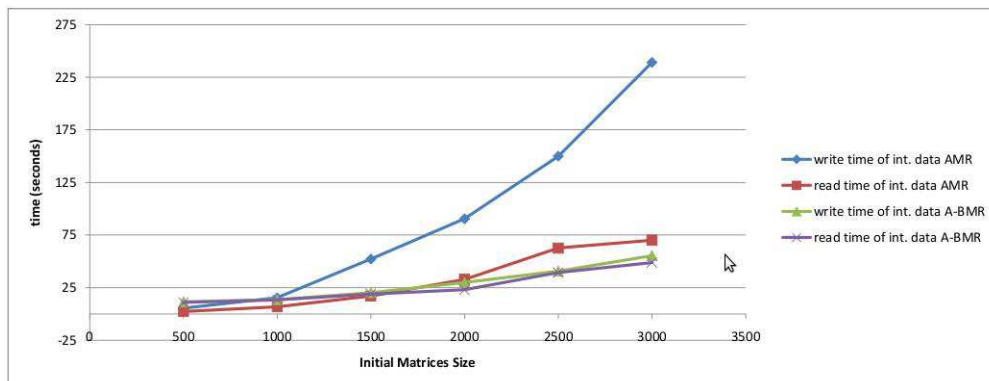

Figure 19: Time for intermediate data depending on the size of initial data

The second set of experiments keep the size of the data constant and vary the number of reducers. Conceptually this means that more shuffles are performed (each mapper performance a shuffle), thus increasing the precision of the univariate analysis. By increasing the number of mappers, we increase the number of concurrent access to the storage system. The charts corresponding to these tests are provided in Figures 20 and 21.

In Figure 20 we present the total time for executing the application with the 2 platforms and the total time for a mapper to complete the job. A-BMR platform obtains better times then the general MapReduce platform, showing that is more adequate for running concurrent jobs. Figure 21 presents the measurements for the times to read and write the intermediate data. By using the A-BlobSeer storage backend the system support better concurrent data transfers thus improving the overall efficiency of the platform.

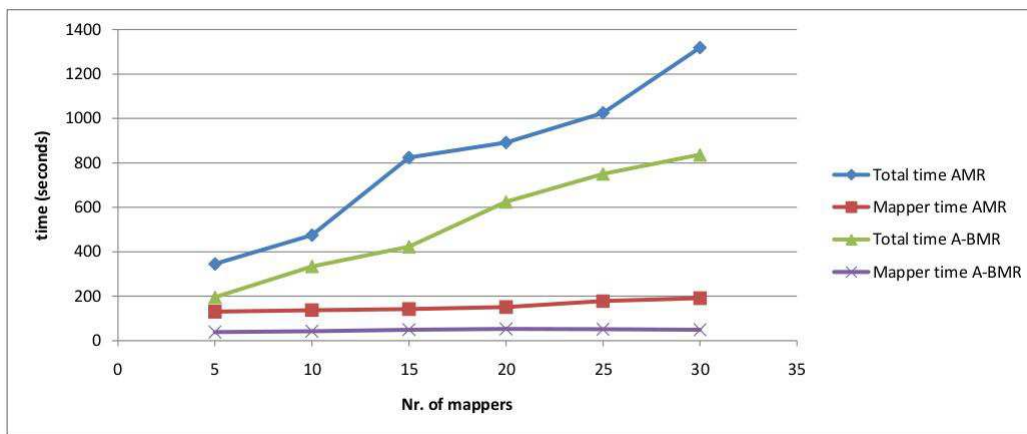

Figure 20: Time depending on the number of map jobs

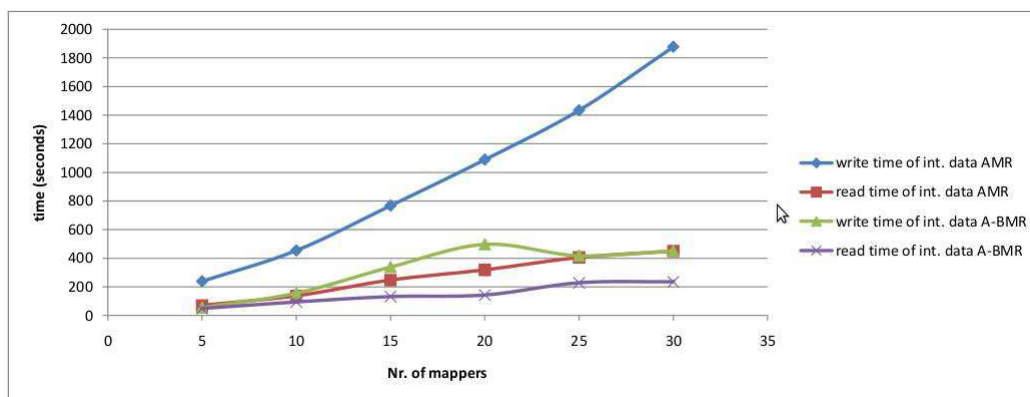

Figure 21: Time for intermediate data depending on the number of map jobs

The experiments presented above show that the A-BMR platform is more suitable for executing data-intensive applications. By increasing the scale of the experiments it was observe that the performance obtained with A-BMR increases over the ones of AMR. In the best case presented in the figures, a 40 % enhancement for the overall time to run the application was reached. These results also demonstrate the efficiency and the impact of the A-BlobSeer contribution which provides a DFS in the computation nodes of the public clouds.

7.3 Contribution III: Iterative A-BMR

This section presents the evaluation for the tuned MapReduce platform for the applications based on univariate analysis. As it was presented in the corresponding section for this contribution, this type of applications need a single final result. Our optimized platform successfully complies to this constraint and still manages to parallelize the reduce phase of the computation. The experiments presented here, test the improvements for the overall computation time, that can be obtained with this tuned platform by involving more reducers in the computation of the final result. We have performed the tests on a platform deployed on 50 nodes, with 30 map tasks that are executed in parallel and with a constant size of the data that is to be processed. The experiments vary the number of reducers and measure the total time of the computation.

Figure 22 presents the results obtained for these experiments. The semi-circle shape for the total time was expected and is due to the times for processing and for manipulating the data. A reducer job can be described by the following sequence of actions: *read data*, *process data* and *write data*. By adding more reducers, the time for processing the data decreases since we parallelize the processing stage. On the other hand, after the point when the processing time becomes comparable to the sum for reading and writing times, the overall time restarts to increase. This is due to the fact that the gain obtain from parallelizing the processing phase becomes smaller then the cost for data manipulation. The same behavior can be observed in the results for our experiments, with an optimum point for the case when 3 reducers are involved in the final computation phase.

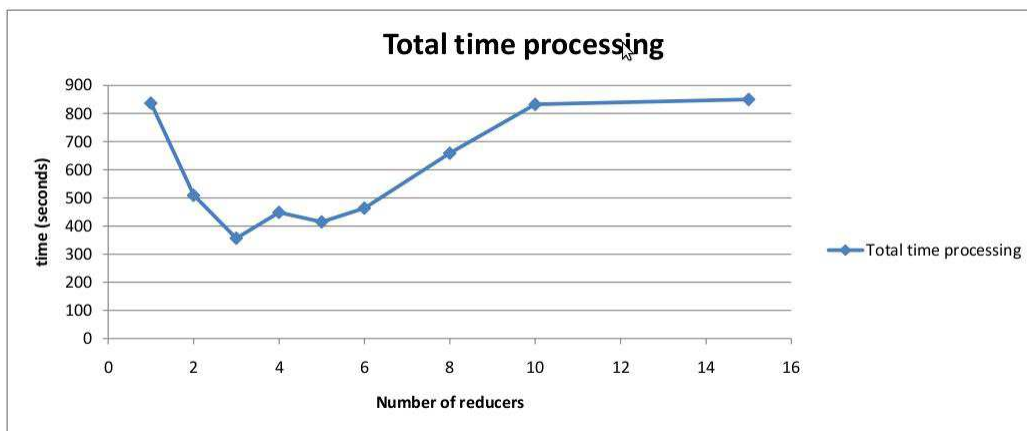

Figure 22: Total time influence by the number of reducers

As it can be observed in Figure 22, the best improvement for the computation time is obtained with 3 reducers. The overall time decreases from approximately 850 seconds down to almost 350 seconds, thus reducing the computation time to more than half. The AMR framework has for the total computation time for this experiment a value of approximately 1350 seconds (see Figure 20). Compared to this, our tuned platform improves the overall computation time almost 4 times. These optimizations that lead to these improvements are useful since they will allow us to simulate the case study application at large scales. By increasing the size of the experiments it will be possible to increase both the precision of the analysis (more shuffles on the initial data) and the size of the analyzed data (more brain

locations and genes will be tested for possible significant links). The future tests that are planned to be done, now that the prototypes were validated, are described in the next section.

8 Future Work

The experiments that were presented previously have validated the approaches that we had proposed and the corresponding prototypes. As future work, these contributions will be used to simulate large tests for the case study application that will serve the biologists to perform a rigorous analysis on the brain. In addition to this application, other data-intensive applications will be simulated using our platforms.

The future work regarding the joint neuroimaging and genetic analysis application will consist in exploiting new ways to parallelize it. So far we have performed the parallelization with respect to the shuffle (permutations) of the initial data. The new directions in which the parallelization will be done will relate to the data. Taking into account that the regression that is currently performed in a mapper consists in matrix operations for computing the correlations, it is worth exploring how these calculations could be divided between more nodes. A computation instance has at most 14 GB of memory, but the total data that could be analyzed (brain images and DNA sequences) can reach terabytes. In order to perform an analysis on all this data, it will be necessary to split it across multiple computation instances.

Another future direction consists in increasing the scale for the experiments. If we refer to the application under study, the scaling must be performed in the same rhythm with the increasing of the size of the simulations done, in order not to waste computation power. Hence, the scaling directions will involve both increasing the size of the data processed and the number of nodes that will perform the computations.

The A-BMR MapReduce platform that we propose has shown very good results for the neuroimaging application which we have used to validate the platform. As a future work in this direction, other data-intensive applications with different data patterns will be run. Based on the fact that the A-BlobSeer storage backend used by A-BMR supports concurrent access on the same data, for both read and write operations, it will be possible to execute in the Azure public cloud applications that involve such patterns. Such applications could not be previously executed in Azure since its remote storage, the Azure BLOBs, do not support concurrent writes on the same data.

Until so far the experiments were done on small machines that had 1 CPU allocated (see Table 1). When the scaling will be performed, several options in which this can be done are available:

- the number of virtual machines is increased, but the size of the machines is the same (the same number of CPUs are allocated per virtual machine)
- the size of the virtual machines is increased, so even if the same number of machines are used, the number of CPUs increases
- a combination between the previous ones

So far there is no study about which of these possibilities gives the best results. Hence, it is worth testing the performances obtained by having more CPUs in a machine (bigger virtual machines) versus having the same number of CPUs allocated for different machines (more

virtual machines). Based on this study we can decide in which direction it is worth scaling our platforms in order to obtain the maximum benefits from the rented computation cores.

To sum up, our main focus consists in exploring new ways in which optimizations can be provided for MapReduce platforms for data-intensive applications. The optimizations refer both to optimizing the data management and transfer in such platforms and to improving the gain obtained from parallelizing the applications. Such optimizations can help to improve the computations performances for a large spectrum of scientific data-intensive applications.

9 Conclusions

The work presented in this report focused on providing solutions for optimizing data storage in public clouds for data-intensive applications. The first contribution of the work exploits the principle of data locality, by providing a distributed file system, called A-BlobSeer, that is deployed on the computation nodes of a public cloud. By moving the data closer to the computation the write performance increased up to 5 times and the read performances increased up to 2 times over the remote storage offered by the cloud. Encouraged by these results we have constructed a MapReduce platform, A-BMR, optimized for data-intensive applications, which uses the A-BlobSeer as storage backend. As a third contribution, the A-BMR platform was tuned for a particular type of data-intensive applications that are based on univariate analysis. These MapReduce platforms provide fault tolerance both for data and for the jobs, they have runtime scalability and exhibit autonomic properties. Security and privacy are also provided together with the other guarantees offered by a public cloud. These platforms were evaluated with a neuroimaging and genetic application and the computation time was reduced up to 4 times over the case when a general MapReduce platform is used. The results obtained validate our approaches and allow the continuation of the work for studying the variability between individuals using the case study application, and as well, executing new data-intensive applications in public clouds.

References

- [1] Amazon MapReduce Webservice. <http://aws.amazon.com/elasticmapreduce/>.
- [2] Amazon Web Service. <http://aws.amazon.com/>.
- [3] Eucalyptus. <http://www.eucalyptus.com/>.
- [4] Google Docs. <https://docs.google.com/>.
- [5] Grid5000. <https://www.grid5000.fr/mediawiki/index.php/Grid5000:Home>.
- [6] Hadoop. <http://hadoop.apache.org/>.
- [7] Microsoft Azure. <http://www.microsoft.com/windowsazure/>.
- [8] Microsoft Live Services. <http://www.microsoft.com/presspass/misc/11-01LiveSoftwareFS.msp>.
- [9] Nimbus. <http://www.nimbusproject.org/>.
- [10] Open Geospatial Consortium. www.opengeospatial.org.
- [11] OpenNebula. <http://www.opennebula.org/>.
- [12] Microsoft: Security Best Practices For Developing Windows Azure Applications, 2008. <http://www.microsoft.com/windowsazure/whitepapers/default.aspx>.
- [13] Michael Armbrust, Armando Fox, Rean Griffith, Anthony D. Joseph, Randy Katz, Andy Konwinski, Gunho Lee, David Patterson, Ariel Rabkin, Ion Stoica, and Matei Zaharia. A view of cloud computing. *Communication of the ACM*, April 2010.
- [14] Rajkumar Buyya, Chee Shin Yeo, and Srikumar Venugopal. Market-Oriented Cloud Computing: Vision, Hype, and Reality for Delivering IT Services as Computing Utilities. *HPCC*, 2008.
- [15] Brad Calder, Tony Wang, Shane Mainali, and Jason Wu. Windows Azure Blob. Technical report, Microsoft. <http://www.microsoft.com/windowsazure/whitepapers/>.
- [16] David Chappell. Windows Azure and ISVs. Technical report, Microsoft. <http://www.microsoft.com/windowsazure/whitepapers/>.
- [17] David Chappell. Introducing the Windows Azure Platform. Technical report, Microsoft. <http://www.microsoft.com/windowsazure/whitepapers/>.
- [18] Ankur Dave, Wei Lu, Jared Jackson, and Roger Barga. CloudClustering: Toward an iterative data processing pattern on the cloud. *International Parallel and Distributed Processing Symposium (IPDPS)*, 2011.
- [19] Jeffrey Dean and Sanjay Ghemawat. MapReduce: Simplified Data Processing on Large Clusters. *Communication of the ACM*, January 2008.
- [20] T. Gunarathne, Tak-Lon Wu, J. Qiu, and G. Fox. MapReduce in the Clouds for Science. *Cloud Computing Technology and Science (CloudCom), IEEE Second International Conference*, 2010.
- [21] Thilina Gunarathne, Judy Qiu, and Geoffrey Fox. Iterative MapReduce for Azure Cloud. *Cloud Computing and Its Applications*, April 2011.
- [22] Zach Hill, Jie Li, Ming Mao, Arkaitz Ruiz-Alvarez, and Marty Humphrey. Early Observations on the Performance of Windows Azure. *High Performance Distributed Computing*,

2010.

- [23] Michael Isard, Mihai Budiu, Yuan Yu, Andrew Birrell, and Dennis Fetterly. Dryad: Distributed Data-Parallel Programs from Sequential Building Blocks. *EuroSys*, 2007.
- [24] Poline J.-B., Lalanne C., Tenenhaus A., Duchesnay E., Thirion B., and Frouin V. Imaging genetics: Bio-informatics and bio-statistics challenges. *International Conference on Computational Statistics COMPSTAT Paris, 1:101-113*, 2010.
- [25] Gideon Juve, Ewa Deelman, Karan Vahi, Gaurang Mehta, Benjamin P. Berman, Bruce Berriman, and Phil Maechling. Scientific Workflow Applications on Amazon EC2. *IEEE International Conference on e-Science*, 2009.
- [26] Howard Karloff, Siddharth Suri, and Sergei Vassilvitskii. A Model of Computation for MapReduce. *SODA '10 Proceedings of the 21st Annual ACM-SIAM Symposium on Discrete Algorithms*, 2010.
- [27] Jeffrey O. Kephart and David M. Chess. The vision of Autonomic Computing. *Computer*, 36 Issue 1, January 2003.
- [28] Craig A. Lee. A Perspective on Scientific Cloud Computing. *High Performance Distributed Computing*, 2010.
- [29] B. Nicolae, G. Antoniu, L. Bougé, D. Moise, and A. Carpen-Amarie. BlobSeer: Next Generation Data Management for Large Scale Infrastructures. *Journal of Parallel and Distributed Computing*, 2010.
- [30] Bogdan Nicolae. *BlobSeer: Towards efficient data storage management for large-scale, distributed system*. PhD thesis, University Rennes 1, 2010.
- [31] Bogdan Nicolae, Diana Moise, Gabriel Antoniu, Luc Bougé, and Matthieu Dorier. BlobSeer: Bringing High Throughput under Heavy Concurrency to Hadoop Map-Reduce Applications. *International Parallel and Distributed Processing Symposium (IPDPS)*, 2010.
- [32] Daniel Nurmi, Rich Wolski, Chris Grzegorzczuk, Graziano Obertelli, Sunil Soman, Lamia Youseff, and Dmitrii Zagorodnov. The Eucalyptus Open-Source Cloud-Computing System. *International Symposium on Cluster Computing and the Grid*, 2009.
- [33] Mayur Palankar, Adriana Iamnitchi, Matei Ripeanu, and Simson Garfinkel. Amazon S3 for Science Grids: a Viable Solution? *Data-Aware Distributed Computing*, 2008.
- [34] Borja Sotomayor, Ruben S. Montero, Ignacio M. Llorente, and Ian Foster. Virtual Infrastructure Management in Private and Hybrid Clouds. *Internet Computing*, September 2009.
- [35] Wittawat Tantisiriroj, Swapnil Patil, and Garth Gibson. Data-intensive file systems for Internet services: A rose by any other name... *Technical report CMU-PDL-08-114*, October 2008.
- [36] Luis M. Vaquero, Luis Roderio-Merino, Juan Caceres, and Maik Lindner. A Break in the Clouds: Towards a Cloud Definition. Technical report, Telefonica Investigacion y Desarrollo and SAP Research Madrid, Spain and Belfast, UK, 2008.
- [37] Tom White. *Hadoop: The definitive guide*. O'Reilly Media, May 2009. <http://oreilly.com/catalog/9780596521981>.
- [38] Yanfeng Zhang, Qinxin Gao, Lixin Gao, and Cuirong Wang. iMapReduce: A Distributed Computing Framework for Iterative Computation. *DataCloud*, 2011.