



HAL
open science

Congestion Control in the context of Machine Type Communication in Long Term Evolution Networks: a Dynamic Load Balancing Approach

Dalicia Bouallouche

► **To cite this version:**

Dalicia Bouallouche. Congestion Control in the context of Machine Type Communication in Long Term Evolution Networks: a Dynamic Load Balancing Approach. Networking and Internet Architecture [cs.NI]. 2012. dumas-00725217

HAL Id: dumas-00725217

<https://dumas.ccsd.cnrs.fr/dumas-00725217>

Submitted on 24 Aug 2012

HAL is a multi-disciplinary open access archive for the deposit and dissemination of scientific research documents, whether they are published or not. The documents may come from teaching and research institutions in France or abroad, or from public or private research centers.

L'archive ouverte pluridisciplinaire **HAL**, est destinée au dépôt et à la diffusion de documents scientifiques de niveau recherche, publiés ou non, émanant des établissements d'enseignement et de recherche français ou étrangers, des laboratoires publics ou privés.



UNIVERSITY OF RENNES 1

RESEARCH MASTER IN COMPUTING SCIENCE, NETWORK AND DISTRIBUTED
SYSTEMS

MASTER THESIS INTERNSHIP REPORT

Congestion Control in the context of Machine Type Communication in Long Term Evolution Networks: a Dynamic Load Balancing Approach

Work done by:

Dalicia BOUALLOUCHE

(daliciabouallouche@inria.fr)

Supervisors:

Adlen Ksentini

(adlen.ksentini@irisa.fr)

Yassine Hadjadj-Aoul

(yassine.hadjadj-aoul@irisa.fr)

DIONYSOS TEAM
IRISA/INRIA RENNES BRETAGNE ATLANTIQUE RESEARCH CENTER

2011/2012

Abstract

Machine Type Communication (MTC) is the automatic exchange of information through a network, including devices or machines, without human intervention. MTC applications aim to endow the machine with intelligence, in order to automate everyday life process. Some of the more established application areas are: health care, city automation, smart energy, positioning and tracking, security and surveillance, etc. MTC devices are generally spread in a wide area and should communicate through widely deployed networks. LTE cellular networks are chosen to support MTC applications since they offer a large coverage, and they are all-IP networks. The benefits of such a deployment are for both MTC application (more opportunities) and LTE networks (more revenues). However, the deployment of MTC applications over LTE networks incurs many requirements and causes challenges. The most important of them is the problem of congestion which is the focus of our work. Indeed, when the huge number of the MTC devices communicate at the same time, congestion occurs in different nodes of the network. In the present work, we propose a dynamic Load balancing and admission control algorithm which deals with the congestion in LTE networks. We balance the load among MMEs (Mobility Management Entities) before moving to the admission control so as to avoid congestion at the core network nodes. Through our discrete event simulator that we developed in C++, we show the efficiency of our solution since we obtain good simulation results, with different traffic patterns.

Keywords: *MTC, LTE, Queueing Theory, Congestion Control, Load Balancing, Admission Control.*

Contents

1	Introduction	5
2	General overview of M2M applications	7
2.1	Overall operation of M2M applications	7
2.2	M2M application features	7
3	MTC applications leverage LTE networks	8
3.1	Architecture and key elements of MTC applications over LTE networks	8
3.2	Traffic management for MTC applications over LTE networks	9
3.3	Classification of MTC applications in LTE applications	11
3.4	Main issues of M2M applications	11
3.5	Congestion in MTC over LTE networks	12
3.6	Congestion Control in MTC over LTE networks : traffic reject approaches	13
4	Overview of Load Balancing approaches	15
4.1	Benefits of load balancing	16
4.2	Some general load balancing algorithms	17
4.2.1	Static load balancing algorithms	17
4.2.2	Dynamic load balancing algorithms	18
4.3	Related works on Load balancing in LTE networks	19
5	MME load balancing in LTE networks	21
6	Our Approach: Dynamic MME Load Balancing and Admission Control (DMLB-AC)	22
6.1	Introduction	22
6.2	Computation of Congestion and Reject Probabilities	23
6.2.1	Congestion Probability	24
6.2.2	Reject Probability	25
6.3	Dynamic MME Load Balancing and Admission Control (DMLB-AC) Algorithm	25
7	Performance evaluation	29
7.1	Simulation model	29
7.2	Simulated network topology	30
7.3	Simulation scenarios	30
7.3.1	Uniform traffic	31
7.3.2	Random traffic with Bursts	37
8	Conclusion	41

Bibliography	43
---------------------	-----------

List of Figures

1	MTC network architecture.	9
2	EPS Bearer Service Architecture [43].	11
3	Congestion areas in MTC applications over LTE networks.	13
4	LTE network with more than one MME	16
5	Concept for MME load balancing [4].	22
6	M/M/1/K State transition diagram.	23
7	Simple M/M/1/K queueing node.	23
8	An execution example of our DMLB-AC algorithm in the case of load balancing among MMEs(Probabilistic routing).	28
9	An execution example of our DMLB-AC algorithm in the case of signaling traffic rejection (Probabilistic rejection).	28
10	Queueing Network Example.	29
11	Network topology for our simulation.	30
12	The Queueing Network model of our topology of simulation.	31
13	The number of packets in different MME queues in our DMLB-AC algorithm (the case of uniform traffic).	32
14	Number of lost packets in different MMEs in our DMLB-AC algorithm (the case of uniform traffic).	32
15	The number of packets in different MME queues for drop tail queue and a round robin distribution of packets (the case of uniform traffic).	33
16	The number of signaling packets lost in different MME queues for drop tail queue and a Round Robin distribution of packets (the case of uniform traffic).	33
17	The number of signaling packets in different MME queues for drop tail queue and a random distribution of packets (the case of uniform traffic)	33
18	The number of signaling packets lost in different MME queues for drop tail queue and a Random distribution of packets (the case of uniform traffic).	33
19	Congestion probabilities of MME 0 and MME 1 (the case of uniform traffic).	35
20	The MME 1 Queue length according to its congestion probabilities (the case of uniform traffic).	35
21	Congestion probabilities of MME 0 and MME 1, Reject Probability and number of rejected packets of eNodeB 1 (the case of uniform traffic).	36
22	Congestion probabilities of MME 0 and MME 1, Reject Probability and number of rejected packets of eNodeB 0 (the case of uniform traffic).	36
23	Congestion probabilities of MME 0 and MME 1, Reject Probability and number of rejected packets of eNodeB 2 (the case of uniform traffic).	36

24	The number of signaling packets in different MME queues in our DMLB-AC algorithm (the case of random traffic with bursts).	39
25	Number of signaling packets lost in different MMEs in our DMLB-AC algorithm (the case of random traffic with bursts)	39
26	The number of signaling packets in different MME queues for drop tail queue and a round robin distribution of packets (the case of random traffic with bursts).	39
27	The number of signaling packets lost in different MME queues for drop tail queue and a round robin distribution of packets (the case of random traffic with bursts)	39
28	The number of signaling packets in different MME queues for drop tail queue and a random distribution of packets (the case of random traffic with bursts)	40
29	The number of signaling packets lost in different MME queues for drop tail queue and a random distribution of packets (the case of random traffic with bursts)	40
30	Congestion probabilities of MME 0 and MME 1 (the case of random traffic with bursts)	40
31	The MME 0 Queue length according to its congestion probabilities (the case of random traffic with bursts)	40
32	Congestion probabilities of MME 0 and MME 1, Reject Probability and number of rejected packets of eNodeB 1 (the case of random traffic with bursts)	41
33	Congestion probabilities of MME 0 and MME 1, Reject Probability and number of rejected packets of eNodeB 0 (the case of random traffic with bursts)	41
34	Congestion probabilities of MME 0 and MME 1, Reject Probability and number of rejected packets of eNodeB 2 (the case of random traffic with bursts)	41

1 Introduction

Machine-to-machine (M2M) communication, also called Machine Type Communication (MTC) ¹, is the automatic exchange of information between end devices such as machines, vehicles or a control center, which do not necessarily need human intervention [33, 45, 38]. The communication between devices is done through wired or wireless systems.

M2M includes technologies like mobile smart sensors, actuators, embedded processors and mobile devices, to interact with a remote server or device, so as to take measurements and then making decisions, or to monitor some physical phenomena, without (or with only limited) human intervention [50, 9]. The role of human is only to collect data.

M2M applications aim to bridge the intelligence in the machine by delegating tasks to them, in order to automate everyday life process. Some of the more established application areas are: positioning and tracking, health monitoring, security and surveillance, fleet management and logistics, point of sales, automation and monitoring, automotive telematics, asset management, etc [9, 10].

Over the last two decades, mobile networks have enabled dramatic advances and changes in telecommunications. Mobile operators have grown to dominate the industry, offering their subscribers a service set as rich as their wired competitors, plus mobility. LTE (Long Term Evolution) network is a 4G wireless broadband cellular network technology (the next-generation network beyond 3G) developed by the 3GPP (Third Generation Partnership Project), an industry trade group [2]. It is named "Long Term Evolution" because it represents the next step (4G) in a progression from GSM (Global System for Mobile Communications), a 2G standard, to UMTS (Universal Mobile Telecommunications Systems), the 3G technologies based upon GSM. LTE provides significantly increased downlink peak data rate of 100Mbits/s in a 20MHz downlink spectrum, and uplink peak data rate of 50Mbits/s in a 20MHz uplink spectrum, backwards compatibility with existing GSM and UMTS technologies, reduced latency, and scalable bandwidth capacity [13].

Recently, standardization activities on MTC over cellular networks have been launched by 3GPP group (SA2 group) [13] the fact that wireless cellular networks offer different network technologies and can widely support a huge number of MTC devices. Current studies aims to make improvements on that side, by supplying necessary network enablers for MTC devices.

The deployment of MTC applications over wireless cellular networks incurs many requirements and causes challenges, namely: to support the huge number of devices, to prevent congestion, to handle heterogeneous traffic characteristics of devices, to give high reliability, autonomy of the device operations, etc.

¹In this document, we assume that terms M2M and MTC are equivalent

The focus of this work is the problem of congestion in M2M applications over LTE networks. Congestion occurs when a considerable number of M2M devices send signaling or data messages at the same time, trying to access the network. The mobile network operations may be thus very impacted, and both MTC and non-MTC traffic could be affected.

In the present work, we propose a solution that deals with congestion at the core part of LTE network with M2M applications. We suppose the case where each eNodeB (Evolved RAN (Radio Access Network)) is connected to more than one MME (Mobility Management Entity), which gives us the possibility to balance the load (signaling packets) among MMEs. The load balancing avoids the case where some MMEs are congested, while others remain under-utilized. Our approach includes two steps, the first consists of balancing the load between the MMEs as much as possible, in order to use the MMEs that are underloaded, and alleviate the load of congested MMEs. To do that, we propose a dynamic algorithm that uses a defined *Congestion Probabilities* to balance the load among MMEs, by a probabilistic routing strategy for MTC signaling traffic. Second, we do an admission control at the eNodeBs (radio part) if all MMEs are likely to be congested and the load balancing is no longer sufficient to avoid congestion. The goal of the admission control is to reduce the traffic, by a probabilistic reject of the signaling traffic according to a defined *Reject Probabilities*. The parameters of the load balancing and the admission control are defined by the MMEs (core network nodes) which monitors the congestion.

To simulate our proposed solution, we developed a discrete event simulator, based on C++. The developed solution uses technical methods from performance evaluation which consist of Queueing Network modeling. By using this kind of performance evaluation, we disregard the details, and we handle the aspects of a system that are essential to its behaviour (which is mathematically analysed). Through the obtained results, we proved that our solution gives the results that we had expected. Thus, it balances the load between MMEs and controls the signaling packets admission efficiently, in order to handle congestion and to avoid packet losses.

This report is organized as follows: Section 2 will be devoted for an overview of M2M applications, namely their features, requirements and properties. In section 3 we define the case of MTC applications over LTE networks and the architecture of this network, we describe how the traffic is managed across this network, we classify MTC applications in LTE networks, we emphasize the problem of congestion in the case of MTC applications over LTE networks, and then we present congestion control approaches in MTC over LTE networks that exist in the literature. In sections 4 and 5, we surround the load balancing, its benefits, existing algorithms that handles the load balancing and some state of the art regarding the load balancing in LTE networks. In sections 6, we present a detailed description of our proposed Dynamic DMLB-AC (Dynamic MME Load Balancing/Admission Control) algorithm. The proposed solution is then evaluated in section 7 through simulations and discussions on the results. Finally, we conclude this report in section 8.

2 General overview of M2M applications

2.1 Overall operation of M2M applications

For every M2M application, there are four common basic stages of communication [9, 20]:

1. Collection of data: the process of M2M communication begins with capturing an event or taking data (temperature, inventory level, etc) using a device (sensor, meter, etc), and then converting it to digital data so that it can be analyzed and sent over a network, using IP packets.
2. Transmission of selected data through a communication network: the data is sent through a network to an application called a server, or to another device. There are several good options for transporting data from the remote equipment to the network operation center, like cellular network, telephone lines, and communication satellites. Nevertheless, M2M applications are mainly deployed over cellular networks, the reason that these later have widespread coverage.
3. Assessment of the data: when the application receives the data, it translates it into meaningful information (data stored, threats detected, etc) [1, 17], in order to be used in practical cases.
4. Response to the available information: after receiving and treating the data, the application (server or device) could send back an answer to the device.

2.2 M2M application features

The requirements of M2M communications are different from H2H (Human-to-Human, e.g. SMS, MMS) or S2H (Service-to-Human, e.g. downloading, streaming) ones, due to the difference between their nature of communications. Indeed, M2M communications are characterized by some features [9, 33, 34] mentioned below:

- Low devices mobility: devices do not move, move infrequently or move in a limited area.
- Large number of devices: a lot of close devices are required for typical applications to achieve high density, or distant ones for a large spread.
- Group based MTC features: devices may be grouped into groups, and each device may be associated with one group. It is interesting for multicast, policing and charging.
- Reduce costs: as these applications are used in everyday life, and may involve a large number of devices.
- Online small data transmission: MTC devices frequently send or receive small amounts of data.
- Time controlled: sending or receiving data permitted only at predefined periods.

- Time tolerant: data transfer can be usually delayed, except in some PAM cases.
- Prior Alarm Messages (PAM): sending messages when immediate attention is needed, in the case of theft, for instance.
- Secure connection: security exchange between devices and server.
- Packet Switched (PS) only: network operator shall provide PS service with or without an MSISDN (stand for Mobile Subscriber Integrated Services Digital Network Number, which is simply a telephone number of a SIM Card in a mobile/cellular phone).
- Location specific trigger: triggering MTC device in a particular area, e.g. wake up the device.

3 MTC applications leverage LTE networks

MTC applications have some technical requirements, among them, mobility, high data rates, efficiently sending signaling and data from devices to servers, etc. Mobile Network Operators (MNO) (like LTE networks) have already an expanded coverage deployed infrastructure, and can withstand these requirements by carrying the data exchanged between remote devices and servers for MTC applications [9, 17, 24, 12, 47]. It is very benefic for M2M applications to find an already and widely deployed infrastructure, with rich services, avoiding, thus, a cost of deploying a dedicated one. But it also offers plethora of revenue opportunities, in fact, M2M ecosystem (devices and services) is undoubtedly the second highest revenue generating area for the MNO after mobile handset ecosystem [9, 37].

3GPP drives to simplify the previous 2G and 3G architectures behind the LTE project to define an all-IP packet only core network called the EPC (Evolved Packet Core network), which means that all packets crossing over this network are IP packets. In the case where MTC applications are integrated in LTE networks, traffic is splitted into signaling, which is the message that a UE (User Equipment) sends for a network connection request, and data is the useful message that a UE sends to the application [9, 32, 46]. Furthermore, LTE architecture is a fully meshed approach with tunneling mechanism over IP transport network [11].

3.1 Architecture and key elements of MTC applications over LTE networks

The general architecture of M2M application over LTE networks is illustrated in Figure 1, which includes the following components [33, 9]:

- M2M device: referred to as UEs (User Equipments), capable on capturing events and data, and then transmitting them autonomously, or replying to requests for data contained within those devices.

- M2M gateways: they ensure M2M devices interconnection and inter-working to the communication network, using M2M capabilities.
- M2M device domain (M2M area network): it supplies M2M connectivity between M2M devices and Gateways.
- M2M Network domain (M2M communication networks): provides communication between M2M Gateways and M2M applications, e.g. xDSN, WLAN, LTE, WiMax, etc.
- M2M application: it is the destination of a data sent by a device over a network. It is used by the specific business-processing engines, e.g. M2M server, client application, etc.

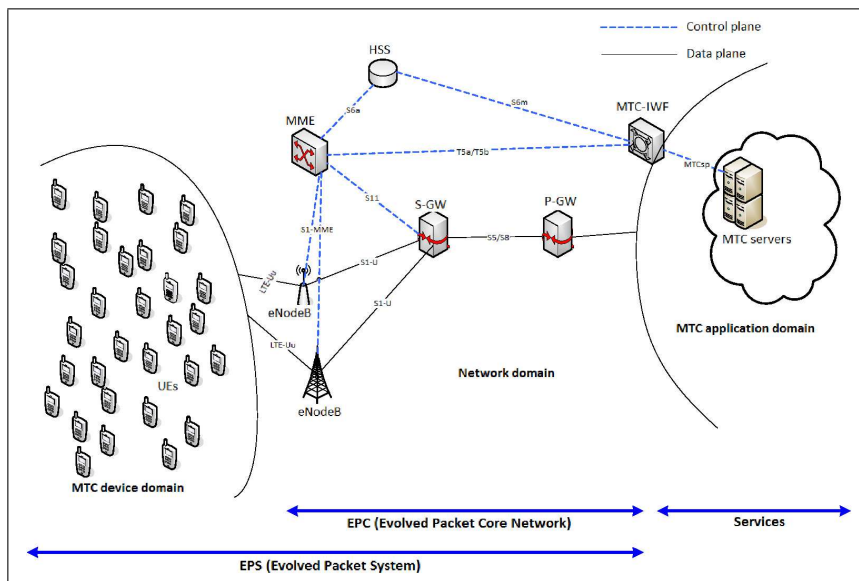

Figure 1: MTC network architecture.

Table 1, defines the most important nodes in the EPC.

3.2 Traffic management for MTC applications over LTE networks

MTC communications in LTE networks use bearers (or tunnels) for messages sending. A bearer is established by the MME. It is created for a bidirectional IP traffic routing between devices (or UEs in LTE networks) and P-GWs, with a defined QoS (Quality of Service), especially just data and not signaling. Multiple bearers could be established for an UE so as to supply different QoS streams or connectivity to different PDNs. It should also across different interfaces to achieve the P-GW. Figure 2 shows the general scheme of the LTE bearer model.

Table 1: EPC’s most important nodes.

Node	Description.
eNodeB	Evolved RAN (Radio Access Network), sophisticated version of LTE base station.
P-GW	Packet Data Node Gateway. It is responsible of allocating IP addresses for UEs, and acts as the interface between the LTE network and external packet data networks, by being the point of exit and entry of the traffic for the UE. An UE may have simultaneous connectivity with more than one P-GW for accessing multiple PDNs. P-GW manages QoS (Quality of Service) and provides deep packet inspection, it also performs packet filtering for each user, sharing support, policy enforcement, and packet screening. Moreover, the key role of the P-GW is to act as the anchor for mobility between 3GPP and non-3GPP technologies such as WiMax and 3GPP2 (CDMA1X and EvDo).
S-GW	Serving Gateway. it routes and forwards user data packets, while also acting as the mobility anchor point for inter eNodeB handovers and as the anchor for interworking between 3G and LTE network. It also manages and stores UE information context, and holds data of downlink bearers when UE is in idle state (e.g. turned off for saving power, etc) and while the MME re-establishes the bearer with the UE.
MME	Mobility Management Entity. It is the key control-node for the LTE access-network. It states, authenticates (by interacting with HSS) and tracks a user across the network. It is also involved in the bearer activation/deactivation process and it assumes functions related to attachment and connection management (authentication and establishing connection and security between the network and the UE). Moreover, it helps to reduce the overhead in the radio network by holding information about UEs. These functions are handled by the Session Management Layer in the Non-Access Stratum (NAS) protocol [9].
HSS	The Home Subscriber Server. It contains subscription data users. It also holds the PDN to which user can connect as well as dynamic information such as MME to which the user is currently attached or registered.
MTC-IWF	MTC Interworking Function hides the internal PLMN (Public Land Mobile Network) topology and relays or translates signaling protocols used over MTCsp to invoke specific functionality in the PLMN.

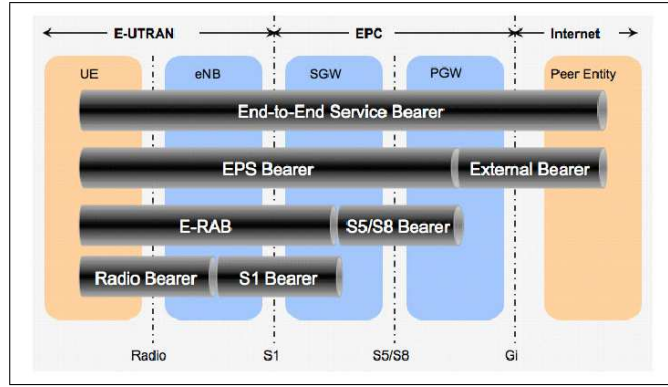

Figure 2: EPS Bearer Service Architecture [43].

3.3 Classification of MTC applications in LTE applications

To simplify the M2M application study, a classification is required. M2M applications are divided into three main classes according to the traffic and its origin, matching with data reporting way in Wireless Sensor Networks [31]. These three classes are:

1. Event driven applications: these applications have more priority than the rest. Indeed, each time an event occurs in the MTC device area, the UEs send messages to the server after being attached to the network, to inform about the event which can be with major importance, for example cardiac arrest in the case of health home monitoring irregular heartbeats or cardiac arrhythmia of a person. While no event occurs, MTC devices are detached from the network all the rest of the time, and remain in idle state.
2. Query driven applications: in this kind of applications, the MTC devices attachments to the network are triggered by a remote MTC server device which sends requests to these MTC devices. Hence, MTC devices can send data after being attached to the network. This is like a pull based application model.
3. Time driven applications: they follow the Event driven applications principle, but in this case, MTC devices send data periodically, every hour for instance.

3.4 Main issues of M2M applications

It is revealed through an analysis of M2M requirements that the challenges of M2M communications arise mainly from the following requirements [26]:

- Support for very high number of devices per cell:
 - To be able to identify all devices. Addressing schemes have to be able to support all these devices.
 - While preventing the congestion due to all the devices that are attempting to access the core network at the same time by sending messages signaling. It is the main study of this internship.

- These devices have varied traffic characteristics (delay tolerance, duty cycle, etc) of M2M communications, making them difficult to find a "one-size-fits-all" and regular transmission intervals solutions for access network and core network operation.
- Low latency and high reliability.
- Some of these devices will be constrained in terms of power and storage. Thus, they require targeted solutions for achieving ultra-low power consumption.
- Support for different mobility profiles.
- The devices should provide autonomous operations, i.e. maintenance and configuration should be human free.
- The requirement that M2M communications must not negatively affect normal operation networks (H2H communications).
- Preventing physical attacks to unmanned devices, compromised (malicious or not) device behavior.

3.5 Congestion in MTC over LTE networks

One of the challenges a cellular network has to deal with is the congestion caused by large numbers of MTC applications. An important number of devices deployed in a small area, communicate frequently or infrequently by small amounts of data, trying to connect to the network, or to send data at the same time, by sharing the same nodes of the network (eNodeBs, MME, S-GW, P-GW, HSS), this obviously leads to congestion. It can also penalize non-M2M devices.

Two main types of LTE network congestion in the context of MTC applications could happen depending on where it occurs [9, 18, 5]:

- Radio network congestion: it happens when a high number of MTC devices are trying almost simultaneously to connect to the network, or to activate, modify and deactivate a connection. It frequently takes place in eNodeBs. More precisely, a lot of devices use the same channels, trying to connect to the same eNodeB.
- Core network congestion: it is congestion that occurs at the EPC part, may be caused by the simultaneous transmissions from a large group of MTC devices attaches, to different cells. It appears in the MME (and hence HSS if a lot of devices have registered to the same HSS), S-GW, and P-GW.

These types of congestion are shown in figure 3.

Congestion due to user data packets is of less importance for this moment, thanks to the LTE-advanced radio technologies and LTE's wide bandwidth. Indeed, 3GPP concentrates mainly on finding effective mechanisms and terms in order to manage congestion caused by lot of signaling messages coming from several MTC devices.

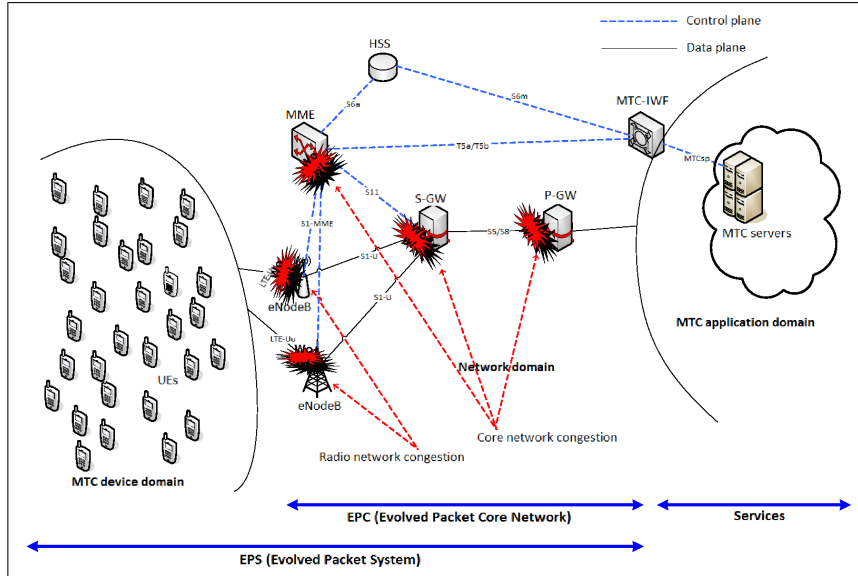

Figure 3: Congestion areas in MTC applications over LTE networks.

3.6 Congestion Control in MTC over LTE networks : traffic reject approaches

Recently, some congestion avoidance schemes in LTE networks in the context of MTC application have been proposed. Two categorical classes are distinguished:

1. Soft mechanisms: in this category, the mobile operator seeks to minimize the frequency of MTC device attempts using soft measures, in order to carry out a particular procedure without having to throttle them. Some solutions under this head are:
 - Triggering MTC devices: the attachment of devices to the network is allowed if the MTC application or server sends alerts to the concerned devices, through the network. It is called a pull model. This can be done under the constraint that devices are not mobile (the location is known by the application).
 - Reducing Tracking Area Updates (TAUs) signaling: TAU is used by the device to notify the network about its current location within the network. But sometimes it is unnecessary in the case of MTC devices with low mobility feature. Therefore, they minimize this kind of signaling by increasing the TAU period timer, on completely disabling it for static MTC devices.
2. Rigid mechanisms: rigid measures are taken by the mobile network operator to dismiss MTC devices that attempt to connect to the network if these simultaneous connections lead to contention. The following approaches are implemented accordance with this category:
 - The grouping of MTC devices: the aim is to form groups of devices based on features or metrics like low mobility, low priority access, online/offline small data transmission, etc. The core network (mainly HSS) should have informations about the groups and devices that belong to a group. Regarding the

subscription, the group is appeared as a single entity. Signaling overhead can thus be reduced and the devices' management is simplified in terms of traffic, policing and charging.

- Allocation of grant time, forbidden time and communication window: these periods (based on the HSS subscription of the device) define the times when devices are allowed or not to attach to the network. During the "grant time interval", MTC devices are authorized to connect to the network. In contrast to "forbidden time interval" where MTC device connection is not authorized. During the grant time interval, in some applications, MTC devices do not need to connect to the network all this time. Indeed, a short communication window, which is sufficient for accomplishing the objectives of the targeted applications, is assigned to the devices during the grant time interval.
- Randomization of access times of MTC devices over the communication window: in order to reduce peaks in signaling and data traffic during short communication window (due to several network connection attempts of MTC devices), the start time of the different MTC devices communication windows are randomized and distributed over the grant time period.
- Connection request rejection: it is another approach to cope with signaling congestion. It is to reject MTC signaling traffic (of MTC devices) either at RAN (Radio Access Network) or MME. This rejection operation should not affect non-MTC traffic, but have to target only MTC traffic of MTC applications that are causing congestion. Two rejection sources can be distinguished:
 - Rejection by the RAN: in this case, to trigger MTC control access for overcoming congestion caused by MTC applications, the MME sends a notification message to RAN nodes (according to a congestion status feedback from P-GWs and S-GWs) to inform them about MTC barring information (e.g. barring factor, MTC group to block barring time, etc). Also, RACH (Random Access Channel) resources can only support low and medium traffic load, hence, unsuitable for MTC traffic which generates a lot of sending data. In fact, the risk of collision increases for both MTC and non-MTC traffic. To treat this problem, the work in [11] proposes different alternatives to control MTC access at the RAN level:
 - * Separating RACH resources for MTC and non-MTC devices, to maintain normal network access for non-MTC traffic and limit the amount of MTC traffic entering the network.
 - * To complete the precedent solution, they include dynamic allocation of RACH resources. Where RACH resources can be dynamically increased by the network for the benefit of MTC devices, in the constraint that the network knows the period of time the MTC devices have to transmit.
 - * Using specific large Backoff window for MTC devices so as to disperse the access attempts from MTC devices in large time intervals in order to overcome the RACH resources contention with UEs, and increase the access probability for non-MTC traffic that have higher priority.

- * ACB (Access Class Baring). This method aims to effectively minimize the probability of collision in the case of several transmissions at the same time in the same RACH resource. In fact, it broadcasts an access class factor p (which is a probability of access) to the UE/MTC devices. Each UE generates a random number n then decides locally whether it can be proceed to the random channel access. If this random number is equal to or greater than p , then access is barred for a mean access barring time duration.
 - * CAAC (Congestion-Aware Admission Control) [9]. It is similar to the former ACB but the difference is that: first, in CAAC, the reject probability p is derived by EPC nodes (MME, S-GWs and P-GW) under congestion, whereas ACB have no instructions on how to compute the reject probability p . Second, MTC devices are grouped into groups according to their priority classes, and the probability p is assigned to each group. Finally, accepting or rejecting MTC traffic is done at the eNodeBs unlike in ACB where the decision is made at the UEs.
- Rejection by the MME: its principle is that MME determines authorized times for each MTC device, by mean of HSS which informs MME on grant and forbidden time intervals as part of MTC subscription, and communicates them through MTC server to the respective MTC devices. However, congestion may occur during authorized times, in this case, MTC devices are provided with back off times for a later access after their connection was rejected by the MEE, or a congestion control notification message is sent to them so as to reduce data transmission rate.

Our work consists of controlling the congestion that occurs at different nodes of the LTE network. We particularly focus on controlling congestion at the core network part (MMEs) in the case of LTE networks that have more than one MME for each eNodeB, as illustrated in figure 4. We deal with congestion in two steps. First, we balance the load as much as possible among MMEs to avoid that some MMEs are likely to be overloaded, while others remain underloaded. Second, if the load balancing among MMEs is no longer sufficient, we move to the admission control to reduce the traffic at the radio part (eNodeBs).

4 Overview of Load Balancing approaches

Load balancing is an important element for the implementation of services brought to grow. Its basic principle is to distribute service requests (tasks) across a group of servers, in intelligent manner. For this, a process of redirecting the tasks depending on the occupancy state of servers is required.

Commonly, load balancing systems includes popular web sites, large Internet Relay Chat networks, high-bandwidth File Transfer Protocol sites, Network News Transfer Protocol (NNTP) servers, Domain Name System (DNS) servers [53] and also evolved to support databases. Indeed, network overloads as well as server and application failures often threaten the availability of these applications. Whereas, they are expected to provide

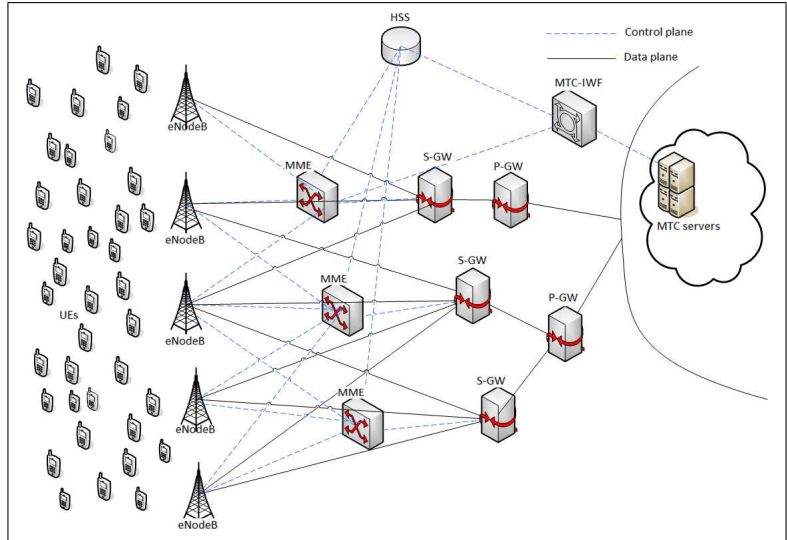

Figure 4: LTE network with more than one MME

high performance, high availability, secure and scalable solutions to support all applications. Resource utilization is often out of balance, resulting in the high-performance resources remain idle while the low-performance resources being overloaded with requests. Hence, for overload, performance and availability problems, a load balancing mechanism is a powerful technique and a widely adopted solution.

LTE network is a promising candidate for next generation wireless networks. But like GSM and WCDMA, it still has the problem of load unbalance [49]. Much research has been done to deal with the load unbalance problem, we will see some of them later.

4.1 Benefits of load balancing

Load balancing has many benefits and deals with various requirements that are becoming increasingly important in networks. It is particularly essential for networks that are very busy, it is in fact difficult to determine the number of requests that will be issued to a server. Therefore, the gains are significant:

- Increased scalability, High performance, High availability and disaster recovery.
- Having multiple servers handling many requests, and using a mechanism of load balancing to detect and identify the server that has sufficient availability to receive the traffic improves response time services.
- Load balancing permits to continue ensuring the service which remains available to users even if a server experiences downtime, because the traffic will be routed to another server, depending on its load, proximity, or health.
- Optimal utilization of servers.
- Ensures that no single server is overwhelmed.

4.2 Some general load balancing algorithms

The key feature of a load balancing process is its ability to direct service requests intelligently to the most appropriate server. We will present various load balancing algorithms, based on different parameters. Load balancing algorithms are classified into two typical approaches, we have static load balancing algorithms and dynamic ones [40, 16, 54]:

4.2.1 Static load balancing algorithms

In static load balancing [40, 16], the performances of the processors and the decisions related to load balance are determined at the beginning of execution, when resource requirements are estimated. Then depending on the processors performances, the work load is distributed from the start by the master processor [15, 29]. Static load balancing methods are nonpreemptive, indeed, a task is always executed on the processor to which it is assigned [40, 16].

Static load balancing schemes aim to reduce the overall execution time of concurrent program while minimizing the communication delays. Their main drawback is that the selection of a host for process allocation cannot be change during the process execution to make changes in the system load, because it is made when the process is already created. We will see some types of static load balancing algorithms:

1. Round Robin algorithm

It is a simple algorithm that distributes processes evenly between all processors [40, 16]. Each new process is assigned to a new processor in round robin order. It means that the selection is performed in series and will be back to the first processor if the last one has been reached. The advantage of round robin algorithm is that it does not require inter-process communication, and with equal workload round robin algorithm is expected to work well [36, 52, 53].

2. Weighted Round Robin algorithm

It is an enhancement of round robin algorithm which takes the response-time as a weight. Indeed, response times for each processor (or server) are constantly measured to determine which processor (server) will take the next process (or server).

3. Randomized algorithm

In Randomized algorithm the processors (or servers) are chosen randomly, they use random numbers generated based on a statistic distribution [36, 40, 16].

Round Robin and Randomized schemes are not expected to achieve good performance in general case, but for particular special purpose applications, both can attain the best performance among all load balancing algorithms, and they tend to work well when the number of processes (requests) are larger than the number of processors (servers) [29].

4. Central Manager algorithm

In this algorithm, a central processor selects a server (or processor) to be assigned a request (process) [40, 28]. When a request is sent (or a process is created), the chosen server is the least loaded one. Central load manager retrieves informations

each time the load on system load state changes. It, hence, allows the best decision for assigning the request (or the created process) because it makes load balancing decision based on the system load information.

This algorithm is expected to perform better than the parallel applications, especially when dynamic activities are created by different servers. However, high degree of inter-process communication could make bottleneck state [40, 16].

5. Threshold algorithm

The principle of this algorithm is that the processes are assigned locally to processors immediately at the time of their creation. Each processor keeps a private copy of the system's load and one of three levels characterizes the load of a processor: underloaded, medium or overloaded. Two threshold parameters can be used to describe these levels: t_upper and t_under [40, 16]. So, we have:

- $load < t_under \Rightarrow$ Under loaded.
- $t_under \leq load \leq t_upper \Rightarrow$ Medium.
- $load > t_upper \Rightarrow$ Overloaded

All processors are initially considered to be under loaded. Each processor sends messages to all other processors as soon as its load state exceeds a load level limit (t_upper) regarding the new load state, so as that all processors regularly update their load to the actual load state of the entire system. The process is allocated locally by a processor when its local state is not overloaded. Otherwise, it allocates a remote under loaded processor.

Threshold algorithms leads to performance improvements. Indeed, they decrease the overhead of remote process allocation and the overhead of remote memory accesses, because threshold algorithms have low intrer-process communication and a large number of local process allocations [40, 16].

We also mention that when all remote processors are overloaded, the process is locally allocated even if the local processor is overloaded. Therefore, it is a drawback the fact that it increases the execution time of an application and causes significant disturbance in load balancing, because the load on the overloaded local processor which is selected can be much higher than on the other remote overloaded processors [40, 16].

4.2.2 Dynamic load balancing algorithms

With dynamic load balancing, changes are made to the distribution of work among servers (or processors) at runtime, they use recent load informations when making distribution decision [27, 55]. Dynamic load balancing algorithms differ from the static ones in the fact that they allocate processes dynamically when one of the processors becomes under loaded [51, 41, 22].

1. Central Queue Algorithm

In this algorithm [21, 54], unsatisfied requests and new activities are stored as a cyclic FIFO queue on the main server (host). When new activity arrives at the queue manager, it is inserted into the queue. And each time the queue manager

receives a request for an activity, the request is buffered until a new activity is available if there is no ready activity in the queue. Else it removes the first activity from the queue and sends it to the requester.

When unanswered requests are in the queue and a new activity arrives at the queue manager, this new activity is assigned to the first unanswered request.

The local load manager sends a request for a new activity to the central manager when a processor load falls under the threshold, and if a ready activity is found in the process-request queue, the central load manager answers the request immediately, else it queues the request until a new activity arrives.

2. Local Queue Algorithm

Its principle idea is to, first, statically assign all new processes to processors, then when processors get underloaded (their load falls under the threshold), a host initiates a process migration [21]. When a local host gets under-loaded, a comparison between the minimal number of ready processes of the local load manager and the remote load manager occurs to decide for the process migration. Some of the running processes are transferred to the local host if the minimal number of ready processes of the remote load manager is greater than the minimal number of ready processes of the local load manager. [40, 54].

A good description of customized load balancing strategies for a network of workstations can be found in [56]. More recently, Houle and al. [19] consider algorithms for static load balancing on trees, assuming that the total load is fixed.

4.3 Related works on Load balancing in LTE networks

There are several ways to do load balancing in LTE networks, some of them are: In [49], they develop a practical algorithm for load balancing among multi-cells in 3GPP LTE networks with heterogeneous services. Its purposes are the load balancing of index of services with QoS requirements and network utility of other services. 3GPP LTE down-link multi-cell network deals with heterogeneous QoS users requirements, namely CBR (Constant Bit Rate) and BE (Best Effort) services.

Here, load balancing which is realized through enforced handover, aims to achieve maximum load balance index for CBR as well as utility function for BE users ([49], page 2). This paper proposes a heuristic and practical realtime algorithm which could be executed in a distributed manner with low overhead, and could solve this multi-objective optimization problem in a sequential manner [49]. Its objective is that, first, in response to varying network conditions, each eNodeB in the network makes handover decision quickly and independently², and second, to minimize the overhead of user status information exchange for decision making at each eNodeB. They propose a framework that consists of three aspects: QoS-guarantee hybrid scheduling, QoS-aware handover and call admission control.

The first one consists of allocating resources according to the rate requirements for CBR users before scheduling the remaining resources for BE users to maximize the network

²3GPP LTE network has a flat network structure without a central controller. Unlike UMTS that has radio network controller (RNC)

utility, because BE users have less QoS requirements than CBR ones. They could use opportunistic scheduling among all CBR users to achieve less resource occupation for each CBR user, then the resource allocation depending on the average bandwidth efficiency is conservative.

In the case of BE users, they use the proportional fair scheduling in which all BE users have the same log utility function.

For the QoS-aware handover, they define a CBR user load balancing gain that permits for the CBR user to switch from cell i to cell j . When many CBR users are about to change their serving cells at the same time (which may result in oscillation of handover), a cell i chooses the best CBR user that achieves the largest benefit by changing its serving cell. Similarly, for a BE user, they define a load balancing gain of BE users, and the BE user that the cell selects is the one that achieves the largest gain because of changing its serving cell.

Finally, for the Call Admission Control, when a new CBR user enters the network, the condition of its admission to access a cell i is the availability of enough time-frequency resource to satisfy its QoS demand. However, for new BE user entering the network, there is no constraint on cell access.

Other researches deal with load balancing problem in LTE-linked packet switched networks. They often do not take into account QoS requirements, and use only proportional fairness as the scheduling metric among competing users [49, 14, 48]. Hence, other works include the QoS requirements by proposing a weighted proportional fairness scheduling schemes [39, 25] to reflect the network reality where QoS is required. However, users' QoS requirements cannot be strictly guaranteed by the weighting method.

A self-optimizing load balancing algorithm in LTE mobile communication system is proposed in [23]. Its objective is to further improve network efficiency by delivering additional performance gain. This is possible with the use of load balancing in LTE Self-Optimizing Networks (SON), where the parameter tuning is done automatically based on measurements. Here, the basic principle is to adjust the network control parameters in such a way that overloaded cells can offload the excess traffic to lowloaded adjacent cells, whenever available, with the purpose of achieving load balancing. This load balancing algorithm reacts to peaks in load and distributes the load among neighbouring cells to achieve better performance [44]. It aims to find the optimum handover offset value between the overloaded cell and a possible target cell. This aims to reduce the load in the targeted cell by ensuring that the handed over users to the target cell will not be returned to the source cell.

In this algorithm (of the paper [23]), they first list all the potential Target eNodeBs (TeNB) for load balancing handover and collect RSRP (Reference Signal Received Power) measurements from UEs to potential TeNB. They group users corresponding to the best TeNB for load balancing in accordance with the difference between TeNB and SeNB (Serving eNB: the eNodeB that serves the previous cell) and obtain information from TeNB on available resources. Then, they estimate a number of required PRBs (Physical Resource Blocks) after load balancing handover for each user in the load balancing handover group. This is before applying the load balancing procedure.

Subsequently, each SeNB sorts the list of the potential TeNB for each adjusted values

of the handover offset, with respect to the number of possible load balancing handovers. Then, a predicted (virtual) cell load after handover is estimated for a given handover offset T and cell C from the list of the potential $TeNB$. If this predicted load is lower than a certain acceptable threshold at $TeNB$, load at $SeNB$ is reduced by the amount generated by the users handed over with this offset and handover offset to this cell is adjusted to the T value. This is repeated until the handover offset T is smaller than the maximum allowed value, and the $SeNB$ load is higher than acceptable value threshold. In short, the main goal of this algorithm is to find the optimum HO offset that allows the maximum number of users to change cell without any rejections by admission control mechanism at $TeNB$ side. This is done by evaluating the load condition in a cell and the neighbouring cells, and then estimates the impact of changing the handover parameters in order to improve the overall performance of the network [23].

5 MME load balancing in LTE networks

The MME load balancing is a functionality that permits to direct the attach requests of UEs to an appropriate MME, it aims to distribute the traffic to the MMEs according to their respective capacities, so as to perform load balancing, particularly as LTE networks are planned for large deployments, like M2M applications deployment.

Very few works deals with functionality in the case of LTE networks. The only works that exist are those of 3GPP. We have, first, the load balancing between MMEs, where each MME have a Weight Factor (WF) configured, which is also known as relative MME capacity since it is typically set according to the capacity of the MME itself relative to other MME nodes within the same MME pool [4]. This WF is conveyed to eNodeBs associated with the MME via S1-AP (Application Protocol) messages (see [3]) during initial S1 setup. An eNodeB can communicate with multiple MMEs in a pool, and it decides, based on the WF, to select the MME that can be loaded with attach requests. In fact, the probability of the eNodeB selecting an MME is proportional to its WF. As illustrated in figure 5.

Second, the load rebalancing may be needed if an MME needs to be taken out of service, or if it feels overloaded. Load rebalancing is a way to simply move UE attaches that are registered to a particular MME to another MME within the MME pool. Indeed, when an MME has been overloaded and cannot handle anymore attach requests, it frees up some resources, then it releases the S1 and RRC (Radio Resource Control) connections of the UEs (in ECM-CONNECTED state: a session with an active S1 connection) towards the eNodeBs, while asking UE to perform a "load balancing TAU (Tracking Area Update)". This is transmitted to UEs by eNodeBs in a RRC message. Once a UE gets this message, it sends a TAU message to the eNodeB, which in turn routes the TAU message to another active MME (selected via the MME selection function). Therefore, the MME that is overloaded can move calls to an active MME that is not overloaded, and this, after pulling the UE context of the overloaded MME (via the S10 interface that connects the two MMEs) [35, 7].

Using DNS at eNodeBs is another way to realize load balancing [4]. In fact, the UE

will populate GUMMEI³ (Globally Unique Mobility Management Entity Identifier) to the eNodeB in an RRC message. Then, the eNodeB sends a DNS query to obtain MME information, based on the GUMMEI, and forward the UE message to the selected MME. If this last is not responding, then the eNodeB may forward the call to the next available MME in the pool.

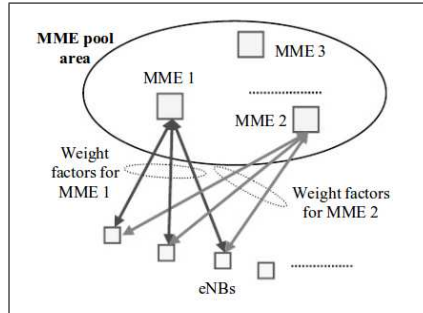

Figure 5: Concept for MME load balancing [4].

6 Our Approach: Dynamic MME Load Balancing and Admission Control (DMLB-AC)

6.1 Introduction

Our proposed approach aims to, first, balance the traffic among MMEs, which will prevent the congestion of some MMEs while the under-utilization of others, and second, to reject the traffic if all MMEs are about to be congested.

The congestion metric used in our approach is the queue length at the IP level. We estimate both Congestion and Reject rates respectively by Congestion Probabilities and Reject Probabilities at MMEs. To calculate these probabilities, we used a strong and wide modeling tool, namely: the Queueing Theory. Its analytical performance evaluation provides a mathematical basis that can help us for understanding and predicting the behavior of our system, and getting its characteristics in order to describe its performances. Precisely, we use the M/M/1/K Queueing System which is appropriate to the MME behaviour in our system. Indeed, the system has a single server, and a finite buffer (k-1 maximum waiting positions in the MME queue) with FIFO queueing discipline [30, 8, 6]. Figure 6 shows the state diagram for M/M/1/K queue model, and figure 7 illustrates a simple M/M/1/K queueing network.

In this queueing system, the packets arrive according to a Poisson process with rate λ (the mean number of packets that arrive per unit time), and the service time is Exponential of parameter μ . New coming packet is lost when he finds the system full.

In fact, at the origin, the traffic that a UE sends to the eNodeB do not follow a pois-

³Globally Unique Mobility Management Entity Identifier. This consists of a Public Land Mobile Network (PLMN) identity, a Mobility Management Entity (MME) group identity and an MME code. The MME code is used in the eNodeB by the Non-Access Stratum (NAS) node selection function to select the MME.

son distribution. However, the aggregation of all the traffic that UEs send is distributed according to a poisson process, with rate λ .

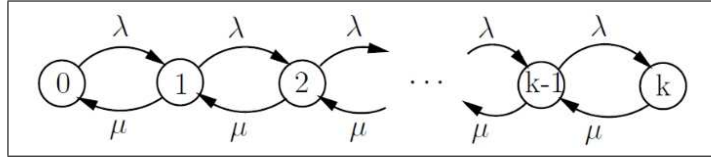

Figure 6: M/M/1/K State transition diagram.

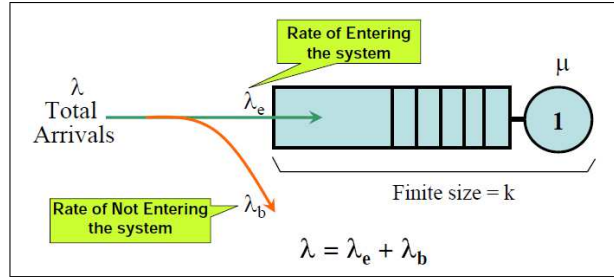

Figure 7: Simple M/M/1/K queueing node.

The overall functioning of our Dynamic MME Load Balancing and Admission Control algorithm is as follows. At first, we aim to balance the load among all MMEs. This is achieved by performing the load balancing at the level of each eNodeB separately (we propose a distributed solution). The load balancing is handled by a probabilistic routing strategy at each eNodeB that is connected to more than one MME, following the *inverseCongestionProbabilities* of MMEs (after calculating the proportions and the cumulative probabilities). The eNodeB retrieves these Congestion Probabilities from its MMEs. We also define a *Congestion Probability threshold* which is the limit that indicates us that the MME will be congested if more packets are forwarded to it.

When all MMEs are about to be congested, which means that there is no way to avoid congestion by balancing the load among MMEs, we move to the second step, which consists of the traffic rejection. Rejecting signaling traffic occurs when MME load balancing is no longer sufficient to deal with congestion. It is done following the *RejectProbabilities*. It rejects the amount of traffic that can cause congestion, in order to maintain the number of packets in the MME queue much smaller than the maximum MME queue length.

Rejecting traffic is done at the eNodeB that have triggered the rejection ((the one who was making the load balancing among its MMEs) as well as at the eNodeBs that share their single MMEs with the eNodeB that triggered the rejection, if they are believed to be the cause of congestion. In other terms, if an eNodeB have its Reject Probability higher than the Reject Probability of the eNodeB that triggered the rejection.

6.2 Computation of Congestion and Reject Probabilities

Analysis of queues requires defining some performance measures, and there are many possible measures of performance for queueing systems, and some of them are: probability of the number of customers in the system, probability of waiting for service, average

number of customers in the system, the average response time, the average waiting time, and the loss packet probability. But in our work, we are about to only use the probability that there are n clients in the system, for estimating both Congestion and Reject probabilities. This probability is defined as follows (eq (1)) [30, 8]:

$$P(n) = \begin{cases} \rho^n \frac{1-\rho}{1-\rho^k} & \text{if } n \leq k \text{ and } \rho \neq 1 \\ \frac{1}{k+1} & \text{if } n \leq k \text{ and } \rho = 1 \\ 0 & \text{Otherwise} \end{cases} \quad (1)$$

Such as:

$$\rho = \frac{\lambda}{\mu} < \infty$$

The quantity $\rho = \frac{\lambda}{\mu}$ gives the system load, it is referred to as *traffic intensity*. For M/M/c systems, there is a stability condition $\rho < c$ that simply shows that the system is stable if the work that is brought to the system is strictly smaller than the processing rate [30, 6]. However, in M/M/1/k the system is always stable, even if $\rho \geq 1$, therefore, there is no stability condition [30, 8].

6.2.1 Congestion Probability

The Congestion Probability (eq (2) and(3)) is computed based on the formula (1). We recall that in our case, the congestion metric is the Queue Length. It means that the probability of congestion is the probability of having the number of packets (attach request) in the queue greater or equal a certain Queue Reference Q_{Ref} . Hence, we define the congestion probability as follows:

$$P_{Cong} = P(n \geq Q_{ref}) = \sum_{n=Q_{ref}}^{k-1} P(n) \quad (2)$$

After replacing $P(n)$ by its formula (eq (1)), we will have:

$$P_{Cong} = \begin{cases} \frac{1-\rho}{1-\rho^k} \sum_{n=Q_{ref}}^{k-1} \rho^n & \text{if } \rho \neq 1 \\ \frac{k-Q_{ref}}{k+1} & \text{Otherwise} \end{cases} \quad (3)$$

For each MME, there can be more than one eNodeB. Thus, the flow (or traffic) entering the MME buffer, comes from all eNodeBs connected to it. So, we will have:

$$\rho = \frac{\lambda}{\mu} \text{ Such as : } \lambda = \sum_{i=1}^{nb_eNBs} \lambda_i \quad (4)$$

and nb_eNBs is the number of eNodeBs connected to an MME.

6.2.2 Reject Probability

The Reject Probability (eq (5) and (6)) is similarly defined as the Congestion Probability. The only difference is in eq (4). So we have:

$$P_{Rej} = P(n \geq Q_{ref}) = \sum_{n=Q_{ref}}^{k-1} P(n) \quad (5)$$

$$P_{Rej} = \begin{cases} \frac{1-\rho}{1-\rho^k} \sum_{n=Q_{ref}}^{k-1} \rho^n & \text{if } \rho \neq 1 \\ \frac{k-Q_{ref}}{k+1} & \text{Otherwise} \end{cases} \quad (6)$$

$$\rho = \frac{\lambda}{\mu} \quad (7)$$

The probability of Reject depends only on a single flow (λ of eq (7)), because we want to estimate the congestion regarding each eNodeB separately, and then reject the traffic following this probability, which is proportional to the number of packets (requests) sent by each eNodeB (more exactly proportional to λ).

Unlike the Reject Probability, the Congestion Probability depends on all the flows coming from all eNodeBs connected to the MME (eq (4)), because we want to estimate the congestion caused by the whole received traffic, in order to control it.

6.3 Dynamic MME Load Balancing and Admission Control (DMLB-AC) Algorithm

Given an LTE network with n eNodeBs, and m MMEs. In the following, we define our DMLB-AC (Dynamic MME Load Balancing/Admission Control) algorithm:

1. Comments on our DMLB-AC Algorithm

When an eNodeB that is connected to more than one MME receives an attach request packet from a UE, we verify the number of MMEs that an eNodeB has. We do the Load Balancing only when an eNodeB has more than one MME. The Load Balancing is not possible if an eNodeB has just one MME.

We define a congestion probability threshold, that we set to 0.5. An MME that has $P_{Cong}^i[j] \geq 0.5$ means that this MME is getting congested. If there is at least one MME that has $P_{Cong}^i[j] < 0.5$, it means that at least one MME is not yet congested, and can still receive traffic. So, we call the *ProbabilisticRouting*($P_{Cong}^i[\]$) procedure, with the Congestion Probabilities $P_{Cong}^i[\]$ as a parameter.

Otherwise, when all MMEs of an eNodeB are getting congested, it means that a the load balancing by a probabilistic routing strategy in no longer sufficient. So, we have to call *ProbabilisticReject*($P_{Rej}^i[\]$) procedure, with the Reject Probabilities $P_{Rej}^i[\]$ as a parameter.

Algorithm 1 DMLB-AC Algorithm

```
1: Each  $eNB_i$  that is connected to more than one MME requests  
   Congestion Probabilities ( $P_{Congi}[j]$ ) from its MMEs;  
2: Each MME $_j$  sends its  $P_{Congi}[j]$  to the  $eNB_i$ ;  
3: When  $eNB_i$  receives a packet (attach request) from a UE :  
4: if ( $Nb\_MMEs\_of\_eNB_i > 1$ ) then  
5:   if ( $\exists MME_j : P_{Congi}[j] < P_{congThresh}$ ) then  $\triangleright P_{congThresh}$  is set to 0.5  
6:     –Call procedure : ProbabilisticRouting( $P_{Congi}[\ ]$ );  
7:   else  
8:     – $eNB_i$  Requests Reject Probabilities ( $P_{Reji}[j]$ ) from its MMEs;  
9:     –Each MME $_j$  sends the corresponding Reject Probabilities to the  $eNB_i$  and  
     to each  $eNB$  that have a single MME, and shares this MME with the  $eNB_i$ ;  
10:    –Call procedure : ProbabilisticReject( $P_{Reji}[\ ]$ );  
11:   end if  
12: else  
13:   –Forward the Packet(Request) to its singleMME;  
14: end if
```

Algorithm 2 Probabilistic Routing Procedure

```
1: procedure PROBABILISTICROUTING( $P_{Congi}[\ ]$ )  
2:   –let  $M$  the set of MME indexes connected to  $eNB_i$ ;  
3:   –Computation of inverse probabilities :  
4:  
5:    $\forall j \in M : P\_INV_{Congi}[j] \leftarrow 1 - P_{Congi}[j]$ ;  
  
6:   –Computation of proportions :  
7:  
8:    $\forall j \in M : P_{Propi}[j] \leftarrow \frac{P\_INV_{Congi}[j]}{\sum_{k \in M} P\_INV_{Congi}[k]}$ ;  
  
9:   –Computation of cumulative probabilities :  
10:  
11:    $P_{Cumuli}[0] \leftarrow P_{Propi}[0]$ ;  
12:   for  $j = 1 : card(M) - 1$  do  $\triangleright card(M)$  is the cardinal number of the set  $M$ .  
13:      $P_{Cumuli}[j] \leftarrow P_{Cumuli}[j - 1] + P_{Propi}[j]$ ;  
14:   end for  
15:    $j \leftarrow 0$ ;  
16:    $k \leftarrow M.first\_element()$ ;  
17:    $unif \leftarrow random(0, 1)$ ;  
18:   while ( $(j < card(m))$  and  $(unif > P_{Cumuli}[j])$ ) do  
19:      $j \leftarrow j + 1$ ;  
20:      $k \leftarrow M.next\_element()$ ;  
21:   end while  
22:   –Forward the Packet(Request) to the MME $_k$ ;  
23: end procedure
```

2. Comments on the Probabilistic Routing Procedure

We balance the load in accordance with the inverse of the Congestion Probabilities or the probabilities that an MME is not getting congested. In other terms, we balance the load by forwarding the traffic according to the remaining capacity of the queue, without achieving congestion (or without exceeding the queue reference Q_{Ref}). For instance, let $P_{Cong}[1] = 0.2$ and $P_{Cong}[2] = 0.5$ the congestion probabilities of the MME_1 and the MME_2 , respectively. The MME_2 has a greater probability to be congested than the MME_1 . It means that, we will forward $(1 - P_{Cong}[1]) * 100 = 80\%$ of the eNodeB traffic to the MME_1 and $(1 - P_{Cong}[2]) * 100 = 20\%$ of the same eNodeB traffic to the MME_2 . With the computation of proportions, we seek to have well dispersed probabilities (with $\sum_{i=1}^m P_{Prop}[i] = 1$). And the computation of the cumulative probabilities is to avoid having two identical probabilities, in order to do a fair routing. These cumulative probabilities are those we use to perform the probabilistic routing attach request packets. The packet request is forwarded to the corresponding MME_j when $unif < P_{Cumul}[j]$.

Algorithm 3 Probabilistic Reject Procedure

```

1: procedure PROBABILISTICREJECT( $P_{Reji}[]$ )
2:    $unif \leftarrow random(0, 1)$ ;
3:   if ( $unif \leq Max(P_{Reji}[])$ ) then
4:     –Reject the packet (attach request);
5:   else
6:     –Call procedure : ProbabilisticRouting( $P_{Congi}[]$ );
7:   end if
8:   if  $\exists j$  so that  $eNB_j$  have a single MME, and shares this MME with the  $eNB_i$ 
9:   if ( $P_{Rej}j > Max(P_{Reji}[])$ ) then
10:     $unif \leftarrow random(0, 1)$ ;
11:    if ( $unif \leq P_{Rej}j$ ) then
12:      –Reject the packet (attach request);
13:    else
14:      –Forward the packet to its single MME
15:    end if
16:  end if
17: end procedure

```

3. Comments on the Probabilistic Reject Procedure

The $eNodeB_i$ (that triggered the rejection) receives the Reject Probabilities ($P_{Reji}[j]$) from its MMEs. The signaling packet rejection will be done according to the highest reject probability among the $P_{Reji}[j]$. Indeed, only $(1 - Max(P_{Reji}[])) * 100\%$ of the incoming traffic is accepted, and

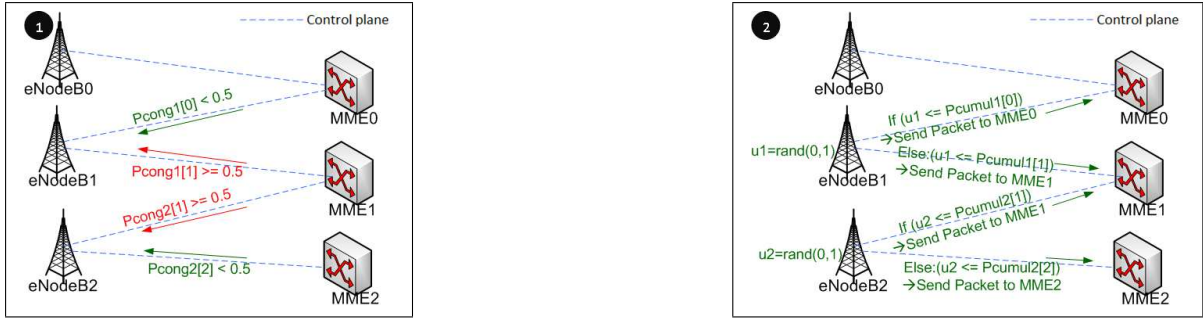

Figure 8: An execution example of our DMLB-AC algorithm in the case of load balancing among MMEs(Probabilistic routing).

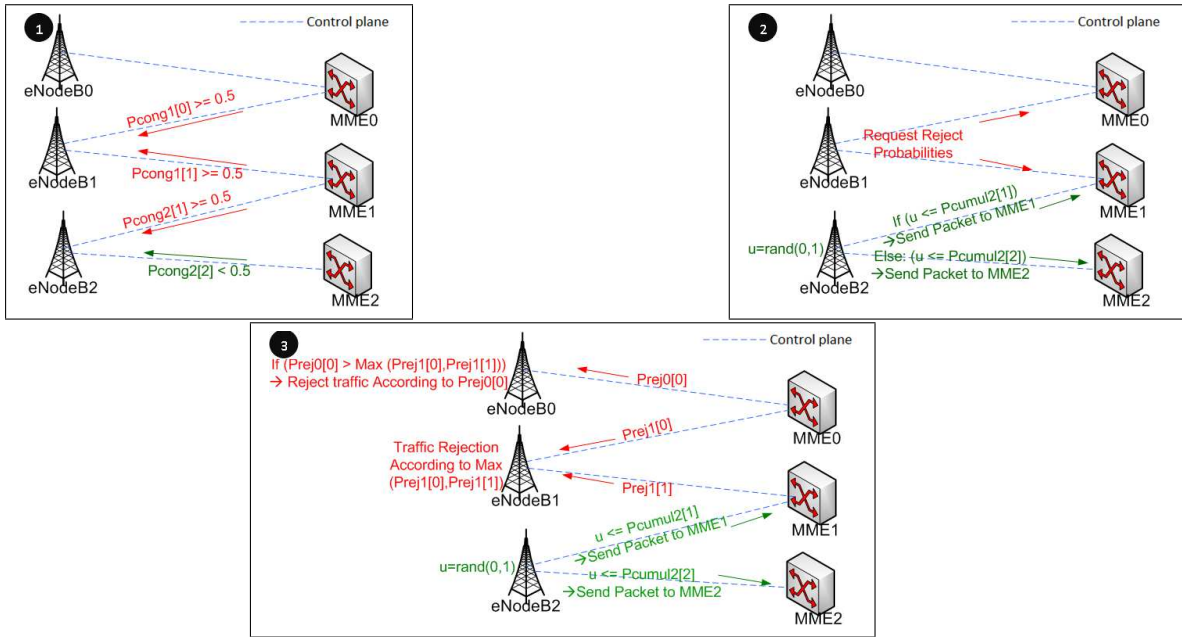

Figure 9: An execution example of our DMLB-AC algorithm in the case of signaling traffic rejection (Probabilistic rejection).

$Max(P_{Rej}^i) * 100\%$ is rejected.

We also test for each $eNodeB_j$, which has a single MME and shares this MME with the $eNodeB_i$, whether it has a greater reject probability (P_{Rej}^j) than the the highest reject probability of eNB_i ($Max(P_{Rej}^i)$). Which means that the $eNodeB_j$ is the cause of congestion. If it is the case, $eNodeB_j$ shall make the admission control and reject traffic at its level, because it is the one that generates the most traffic and causes congestion. We do not reject the traffic at the eNodeBs that have other MMEs (in addition to the one it shares with the $eNodeB_i$ that triggered the rejection) since they (may be) can still balance the load at their levels.

An execution example of our DMLB-AC algorithm in the case of load balancing among MMEs(Probabilistic routing) and in the case of signaling traffic rejection (Probabilistic rejection) is illustrated in figures 8 and 9.

7 Performance evaluation

7.1 Simulation model

We evaluate the performances of our solution using Queueing Network modeling, which is a technical approach of performance evaluation with a probabilistic approach, and we implement our simulator with C++ language. Queueing Network modeling is used to approximate a real queueing situation or system, and the queueing behaviour can be mathematically analysed. Queueing Network is a very important application of Queueing Theory. It is a 'Network of Queues' which is a collection of queues where customers (signaling and data packets in our case) are waiting for accessing a service station (which represent eNodeBs, MMEs, PGWs, and SGWs in our case), and the input from one queue is the output from one or more others.

We chose this kind of simulation because it is the most appropriate for our approach which is based on Queueing Theory and analytical approach of performance evaluation that we use for computing our needed metrics (Congestion and Reject Probabilities), and also because using a model to investigate system behavior is less laborious and more flexible than experimentation, because the model is an abstraction that avoids unnecessary detail. In fact, the Queueing Network model is an abstraction of a system, an attempt to distill, from the mass of details that is the system itself, exactly those aspects that are essential to the system's behaviour. Once a model has been defined through this abstraction process, it can be parameterized to reflect any of the alternatives under study, and then evaluated to determine its behavior under this alternative.

An example of a Queueing Network in illustrated in figure 10.

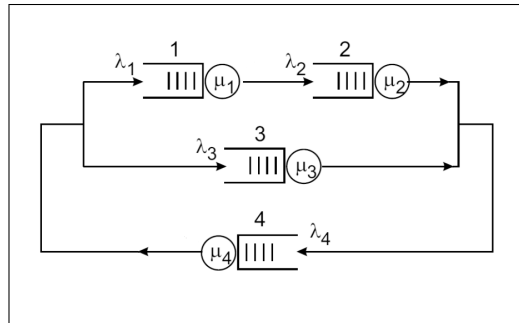

Figure 10: Queueing Network Example.

In our case, the eNodeBs queue type is M/M/1, because the duration between two arrivals and the service duration are exponential, and there is one service station (eNodeB) per queue, with infinite queue size.

The MMEs queue type is M/M/1/K because the duration between two arrivals and the service duration are exponential, there is one service station (MME) per queue, the queue

size is finite and its maximum capacity is K .
The output packets of eNodeBs are the input packets of the MME queues.

7.2 Simulated network topology

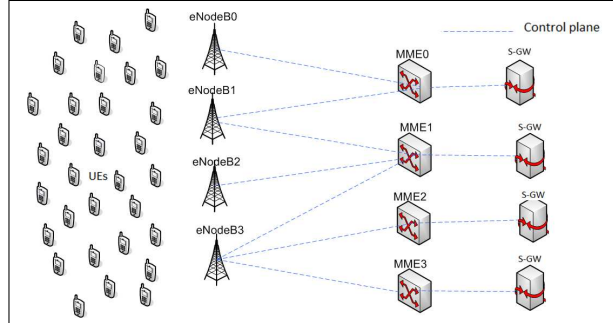

Figure 11: Network topology for our simulation.

Figure 11 illustrates the simulated network topology. We represent only the control plane links, and we do not represent other nodes (PGW, HSS, MTC-IWF, etc) because we deal with only signaling traffic, and we focus on congestion at the Core Network part, especially at the MME level. We are not interested in the Radio part. The goal of our work is to avoid congestion at MMEs and to treat it if it should appear.

The Queueing Network model of our topology is illustrated in figure 12. We represent the eNodeBs by the four queues on the left of the figure. They are connected to different MMEs that we represent by the four queues on the right of the figure.

Our model contains only eNodeBs and MMEs because we deal with congestion due to signaling traffic which goes through eNodeBs and then MMEs. We recall again that the congestion metric that we take into account is the queue length, so a model with Network of Queues is sufficient to model the parts of the LTE network that we need, to approximate a real queueing situation or system, so as the queueing behaviour can be analysed mathematically, and to evaluate the performances of this model using useful steady state performance measures, including the average number of packets (customers) in the system or in the queue, the average time spend in the system or in the queue, the probability to have the system in a certain state (that we use for evaluating the congestion and the reject probabilities), etc.

It is proved that analysis of the relevant queueing models allows the assessment of the impact of proposed changes and to identify the cause of queueing issues.

7.3 Simulation scenarios

In our tests, we consider traffic sent to the eNodeB by the UEs with rate λ *packets/second*, and then packets are sent to the MMEs with different rates (according to the congestion

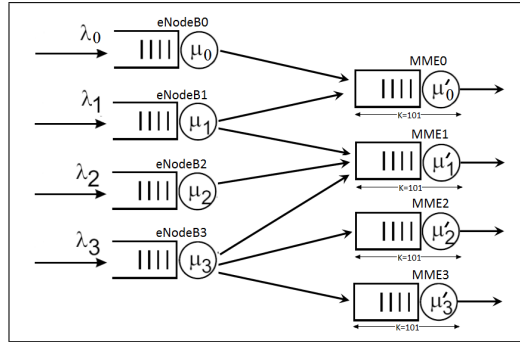

Figure 12: The Queuing Network model of our topology of simulation.

rate of each MME) that we compute at runtime, and which will be then used to specify the congestion probabilities for each MME.

One of the specific characteristics of MTC applications is the bursty traffic it generates, since MTC devices are likely to send data at synchronized periods, like when an event occurs, or when the devices send packets periodically (timer fired). So, we test our approach in the case of *bursty traffic* scenario (which reflects reality), in the case of *uniform traffic* which could also reflect a real scenario [42]. In fact, in a time driven application, nodes are scheduled in different intervals by synchronizing their sendings at the application level, in order to prevent bursts. And also in the case of *random traffic* to generalize the behaviour of the MTC applications in LTE networks in all cases that may occur.

We compare our proposed solution with two other methods: Random Distribution of packets which distributes packets without trying to balance the load between MMEs, and Round Robin Distribution of packets. These two approaches do not have any admission control (traffic rejection), and the queue of the MMEs is of type Drop Tail Queue (FiFo).

7.3.1 Uniform traffic

Here, we consider Uniform traffic scenario. Table 2 shows the parameters of the simulation. In this scenario, the attach requests generated by the UEs toward the eNodeBs are uniformly distributed over the time, so that there is no bursts.

Figure 13 shows the evolution of the queue length of all MMEs in the case of our proposed DMLB-AC algorithm. We note that the queue length of all MMEs are quite similar starting from the second period of simulation. This is due to the fact that we set, at the beginning, the Congestion Probabilities to 0, and starting from the second period, the new Congestion Probabilities are calculated and the traffic reacts according to them. In fact, our goal is to balance traffic between MMEs and to maintain, at each instant, almost the same number of packets in all MMEs, in order to prevent congestion at some MMEs and the under-utilization at others. This is done by our dynamic load

Parameter	Value	Details
$nbMME$	4	The number of MMEs in the network
$nbeNB$	4	The number of eNodeBs in the network
λ	5	The sending rate of the UEs: the mean number of packets sent per second
μ	1	The service rate of the eNodeBs: the mean number of processed packets per second
$Buffer\ size$	100	The maximum queue length
$Q_{Reference}$	100	The limit of the queue that we want to achieve so that there is no congestion
$Period$	100s	The period after which we calculate new Congestion Probabilities

Table 2: Test parameters in case of Uniform traffic.

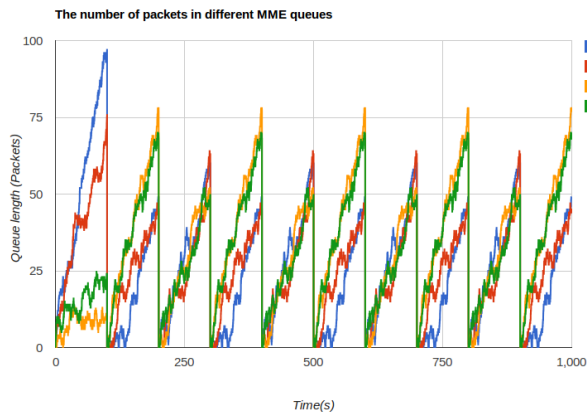

Figure 13: The number of packets in different MME queues in our DMLB-AC algorithm (the case of uniform traffic).

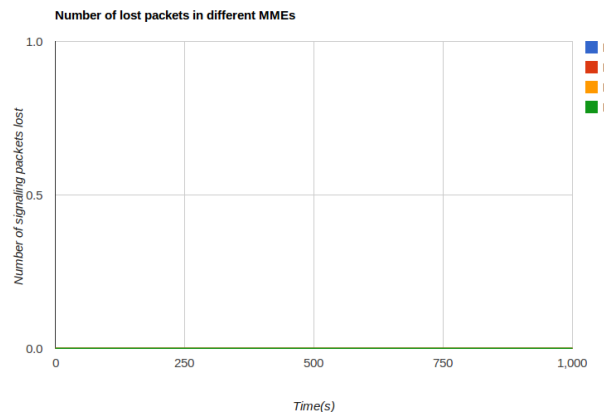

Figure 14: Number of lost packets in different MMEs in our DMLB-AC algorithm (the case of uniform traffic).

balancing algorithm, which rejects the traffic at eNodeBs if necessary, which avoids the loss of signaling packets (see figure 14).

We compare our results above in figure 13 to figures 15 and 17 which, respectively, give the evolution of the queue length in all MMEs in the case of a round robin distribution of traffic and in the case of random distribution of packets. They are two methods that aim to distribute signaling packets to the MMEs without trying to balance the load. We can clearly see that both do not balance the load between MMEs, and some MMEs have to deal with a big amount of traffic while others are under-used, so congestion occurs, and signaling packets are lost. For instance, in the figure 15, the case of round robin distribution of traffic for MMEs, we see that there are packets loss in MME 0 and MME1 (see figure 16), whereas MME 2 and MME 3 are under-utilized, and they could take few packets to unload the congested MMEs. The same goes for the case of random distribution of packets (see figures 17 and 18). Our approach handles well the load balancing, as it avoids this situation.

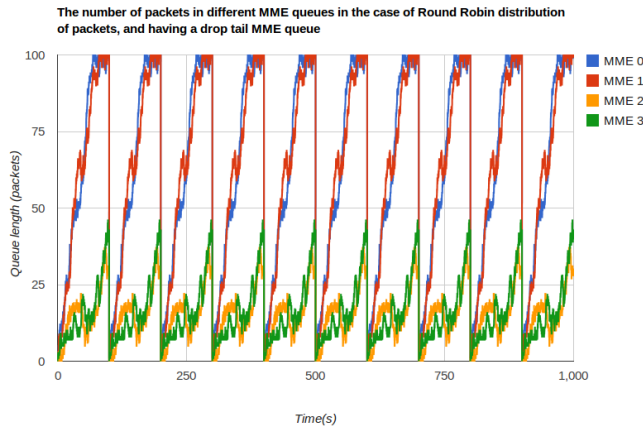

Figure 15: The number of packets in different MME queues for drop tail queue and a round robin distribution of packets (the case of uniform traffic).

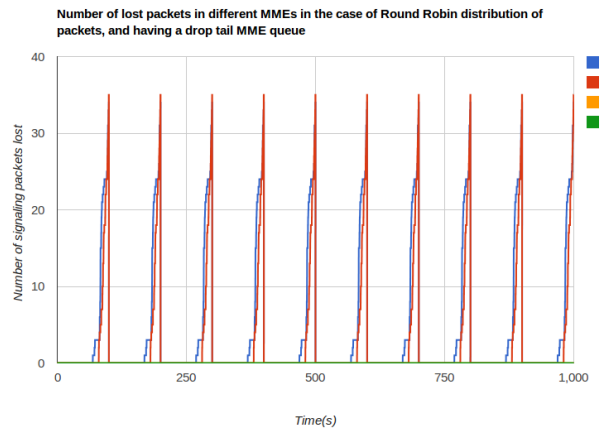

Figure 16: The number of signaling packets lost in different MME queues for drop tail queue and a Round Robin distribution of packets (the case of uniform traffic).

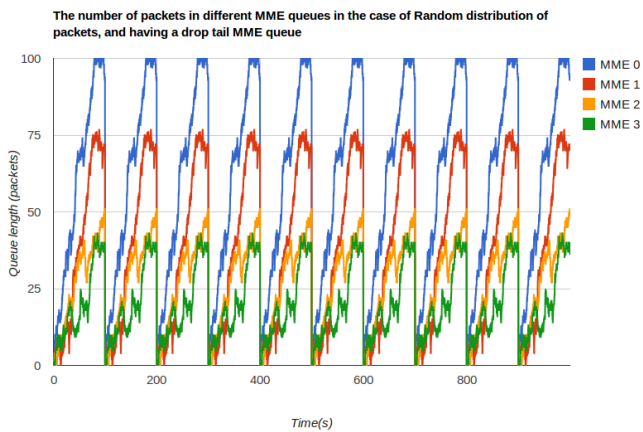

Figure 17: The number of signaling packets in different MME queues for drop tail queue and a random distribution of packets (the case of uniform traffic)

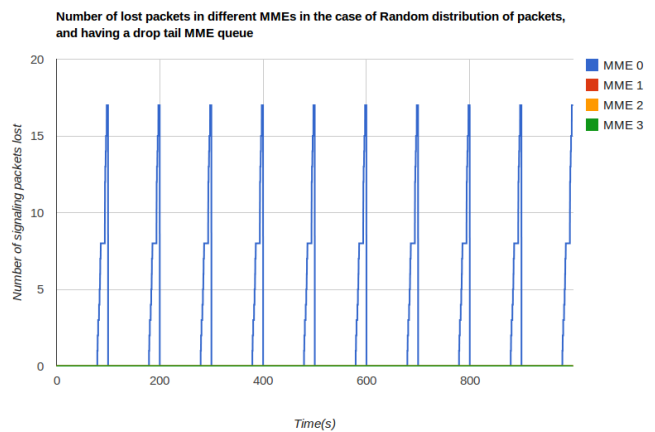

Figure 18: The number of signaling packets lost in different MME queues for drop tail queue and a Random distribution of packets (the case of uniform traffic).

The evolution of the Congestion Probabilities of MME 0 and MME 1 are illustrated in figure 19. The MME 0 and MME 1 Congestion Probabilities tend toward the same value. This is the best that can be expected since the traffic was actually balanced between these MMEs and we recall that we are in the case of uniform traffic. So the most logical is to have Congestion Probabilities that converge to the same Congestion Probability. We note that these probabilities remain fixed for a certain period because we change the congestion probabilities after each period.

Figure 20 shows the evolution of the queue length of the MME 1 with its Inverse Congestion probabilities. We note that the traffic received by the MME follows the Inverse Congestion Probabilities. In fact, when the packet arrival rate increases (or a peak of load occurs), the inverse congestion probabilities decreases (the congestion probabilities increases). Allowing to forward less traffic to the MME 1. In an opposite way, when the packet arrival rate decreases (few packets are received), the inverse congestion probabilities increases (the congestion probabilities decreases). Allowing to forward more traffic to the MME 1. It means that the eNodeBs handle the congestion (through load balancing), by making a probabilistic routing of the signaling packets according to the Congestion Probabilities.

When load balancing is no longer sufficient to control congestion, we must adopt an admission control by rejecting the traffic at the eNodeB level, using Reject Probabilities. This is what figure 21 shows. We recall that the admission control (or rejecting traffic) occurs when Congestion probabilities of all the MMEs of an eNodeB are greater than a congestion probability threshold $P_{congThresh}$ that we set to 0.5. Figure 21 gives the evolution of the Congestion probabilities of MME0 and MME1, the Reject Probability of the eNodeB 1 (which is related to both MME 0 and MME 1), and the number of rejected packets at the eNodeB 1. We clearly see that Congestion Probabilities exceed the congestion probability threshold (0.5), but it does not reject packets since the Reject Probability is very low (0.03 and 0), which means that the eNodeB 1 is not the cause of congestion because it is not the one who send lot of traffic. However in our approach, at the Probabilistic Reject Procedure, we precise that when an $eNodeB_i$ shares its MMEs with other eNodeBs, and each of these eNodeBs has just one MME (the one it shares with $eNodeB_i$), these eNodeBs could be the cause of congestion at their corresponding MMEs if they send a considerable amount of traffic, then traffic must be rejected at their level. To know whether each of these eNodeBs is the cause of congestion at its respective MME, we compare its Reject Probability with the reject probability of $eNodeB_i$, and the one that has a higher Reject Probability is the one who causes congestion.

Figure 22 (respectively figure 23) illustrates the evolution of the Congestion probabilities of MME0 and MME1, the Reject Probability of the eNodeB 0 (which shares the MME 0 with the eNodeB 1) (respectively the eNodeB 2 (which shares the MME 1 with the eNodeB 1)), and the number of rejected packets at eNodeB 0 (respectively eNodeB 2). In both figures, we see that the congestion of the MME 0 and MME 1 is caused by respectively eNodeB 0 and eNodeB 2. So, the admission control is done at their level. And we clearly see that as soon as all the Congestion Probabilities exceed the congestion probability threshold (0.5), packets are rejected at eNodeB 0 and eNodeB2 according to

their Reject Probabilities.

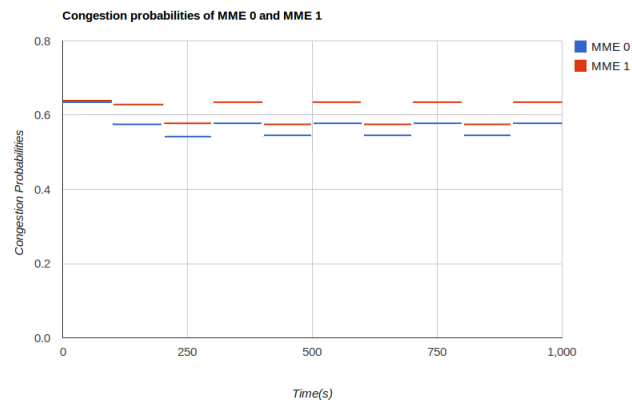

Figure 19: Congestion probabilities of MME 0 and MME 1 (the case of uniform traffic).

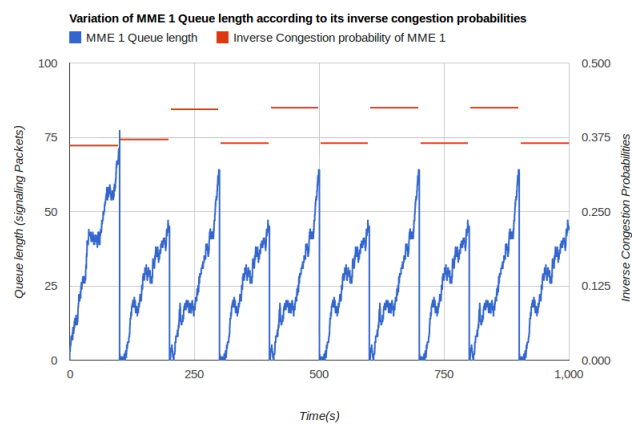

Figure 20: The MME 1 Queue length according to its congestion probabilities (the case of uniform traffic).

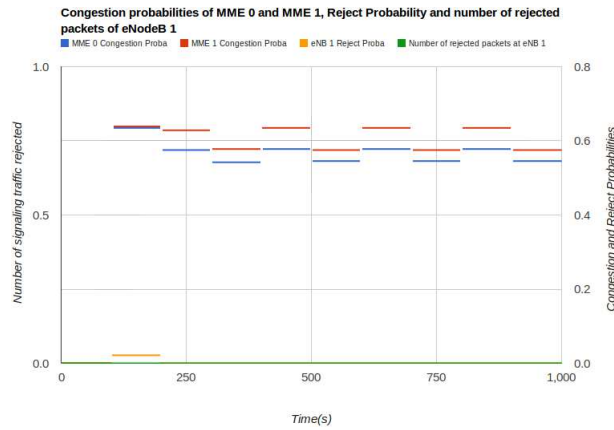

Figure 21: Congestion probabilities of MME 0 and MME 1, Reject Probability and number of rejected packets of eNodeB 1 (the case of uniform traffic).

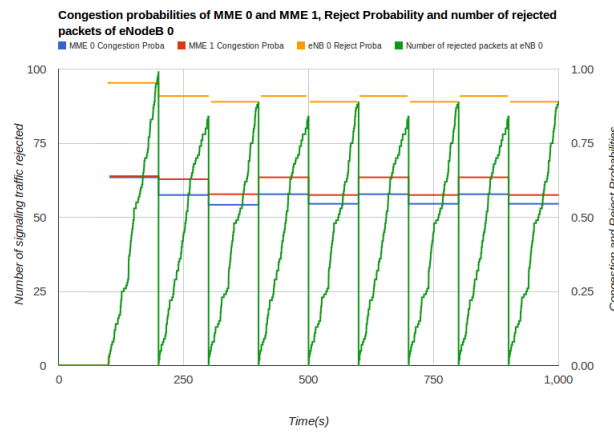

Figure 22: Congestion probabilities of MME 0 and MME 1, Reject Probability and number of rejected packets of eNodeB 0 (the case of uniform traffic).

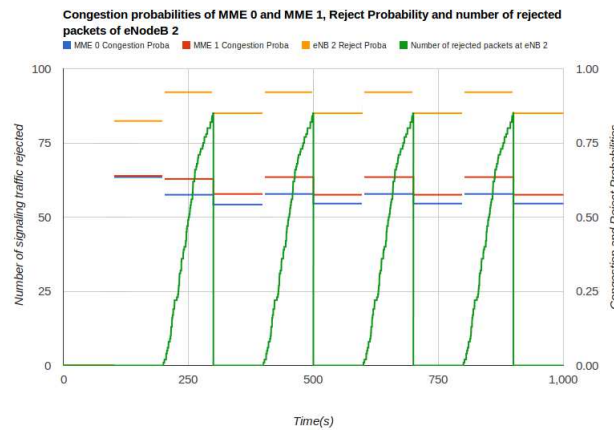

Figure 23: Congestion probabilities of MME 0 and MME 1, Reject Probability and number of rejected packets of eNodeB 2 (the case of uniform traffic).

Parameter	Value	Details
$nbMME$	4	The number of MMEs in the network
$nbeNB$	4	The number of eNodeBs in the network
λ	Random values	The sending rate of the UEs: the mean number of packets sent per second
μ	1	The service rate of the eNodeBs: the mean number of processed packets per second
$Buffer\ size$	100	The maximum queue length
$Q_{Reference}$	100	The limit of the queue that we want to achieve so that there is no congestion
$Period$	100s	The period after which we calculate new Congestion Probabilities

Table 3: Test parameters in case of random traffic with bursts.

7.3.2 Random traffic with Bursts

Here, we consider Random traffic with bursts scenario, and the parameters of the simulation are shown in Table 3.

In this scenario, the attach requests generated by some UEs toward the eNodeBs are sent randomly over the time, and for other UEs the attach requests generated are with bursts. The random traffic is likely to be observed if many applications are deployed independently from each other, and the bursts happen generally in the case of event driven application, in fact, when an event occurs and a big amount of UEs detects it, they send attach requests at the same time to signal this event, which leads to bursts.

The evolution of the queue length in all MMEs in the case of our proposed DMLB-AC algorithm is given in figure 24. We note again that our approach handles well the congestion in the case of random traffic with bursts, since the queue lengths of all MMEs are very close, and it reacts well to the changes of the traffic, and the bursts. In fact, we reach our goal which is to balance the traffic between MMEs. This ensures that all MMEs have almost the same number of packets, by avoiding attach request losses (packet losses) (see figure 25).

Figure 26 and figure 28 give respectively the evolution of the queue length in all MMEs for a round robin distribution of traffic and for a random distribution of packets, in the case of Random traffic with bursts. We compare the results of our DMLB-AC approach (figure 24) with these two previous results (figures 26 and 28), and we recall that they are two methods that aim to distribute signaling packets to the MMEs without trying to balance the load.

We note that for both methods (figures 26 and 28) some MMEs have to deal with a considerable amount of traffic while others are under-used. Signaling packets are lost (see figure 27 and 29) since congestion occurs. Our approach improves highly the load balancing compared to these two methods.

The evolution of the Congestion Probabilities of MME 0 and MME 1 are illustrated in figure 30. The MME 0 and MME 1 Congestion Probabilities tend toward the same value (the difference between them is between 0.01 and 0.1). Then, the traffic was balanced between these MMEs. This is the best that we can expect, because by balancing the load, we have to obtain very close probabilities, since the number of packets have to be nearly the same in each MME queue.

Figure 31 shows the evolution of the queue length of the MME 1 with its Inverse Congestion Probabilities. We note that the traffic received by the MME follows the Inverse Congestion Probabilities. In fact, when the packet arrival rate increases (or a peak of load occurs), the inverse congestion probabilities decreases (the congestion probabilities increases). Allowing to forward less traffic to the MME 1. In an opposite way, when the packet arrival rate decreases (few packets are received), the inverse congestion probabilities increases (the congestion probabilities decreases). Allowing to forward more traffic to the MME 1. It means that even in case of random traffic with bursts, the eNodeBs handle the congestion (through load balancing), by making a probabilistic routing of the signaling packets according to the Congestion Probabilities.

Figures 32, 33 and 34 illustrate the admission control done at the eNodeBs (respectively eNB1, eNB0 and eNB2), when MME 0 and MME 1 queues could be affected by congestion ($P_{Cong}1[0] > 0.5$ and $P_{Cong}1[1] > 0.5$). We recall that the admission control is carried out by rejection the traffic at each concerned eNodeB (the eNodeB that triggers the rejection (eNB 1 in our case) and those who share their single MMEs with it (eNB0 and eNB2 in our case)), using reject probabilities.

In figure 32, Congestion Probabilities exceed the congestion probability threshold (0.5), but only one packet is rejected (between 800s and 900s) because of the very low reject probability (less than 0.01), and no packet is rejected at other instants because the probability congestion is zero, which means that the eNodeBs who cause the congestion is either eNodeB 0 or eNodeB 2 (or both).

We then see in figures 33 and 34 that the cause of congestion at MME 0 and MME 1 is respectively eNodeB 0 and eNodeB 2. So the admission control is done at their levels. And we clearly see that as soon as all the Congestion Probabilities exceed the congestion probability threshold (0.5), packets are rejected at eNodeB 0 and eNodeB2 according to their Reject Probabilities.

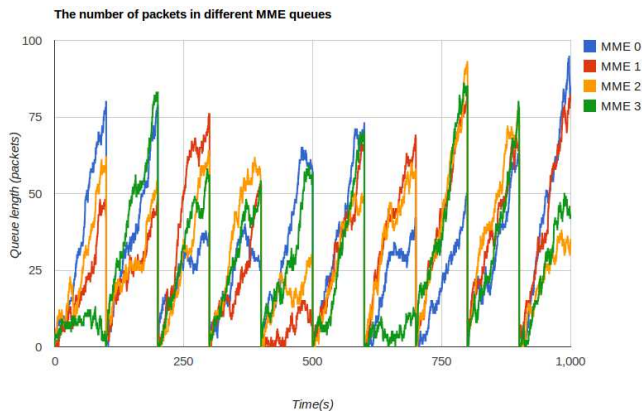

Figure 24: The number of signaling packets in different MME queues in our DMLB-AC algorithm (the case of random traffic with bursts).

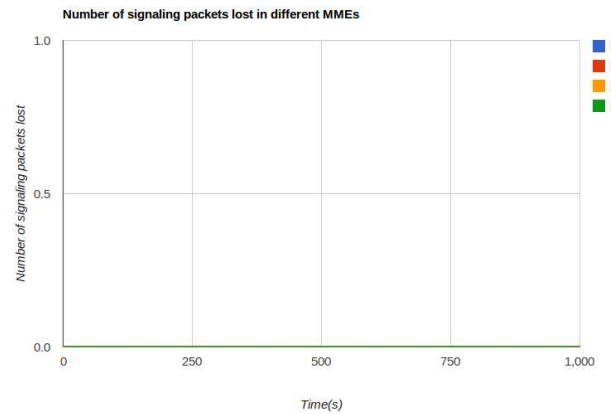

Figure 25: Number of signaling packets lost in different MMEs in our DMLB-AC algorithm (the case of random traffic with bursts)

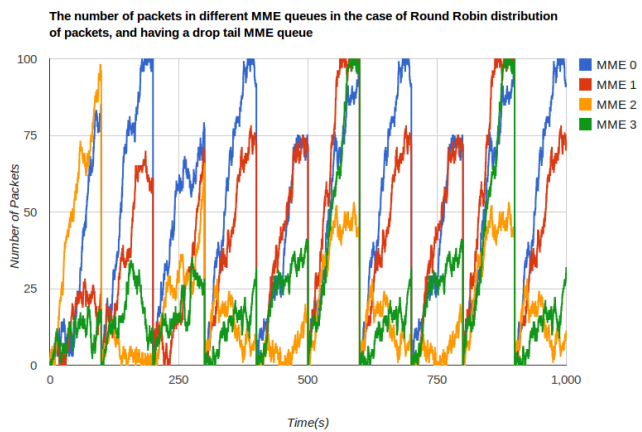

Figure 26: The number of signaling packets in different MME queues for drop tail queue and a round robin distribution of packets (the case of random traffic with bursts).

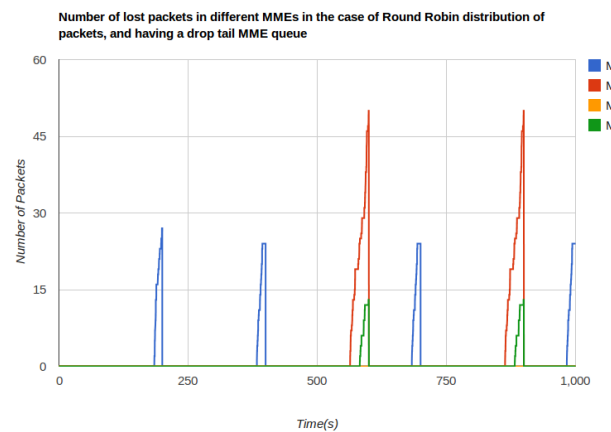

Figure 27: The number of signaling packets lost in different MME queues for drop tail queue and a round robin distribution of packets (the case of random traffic with bursts)

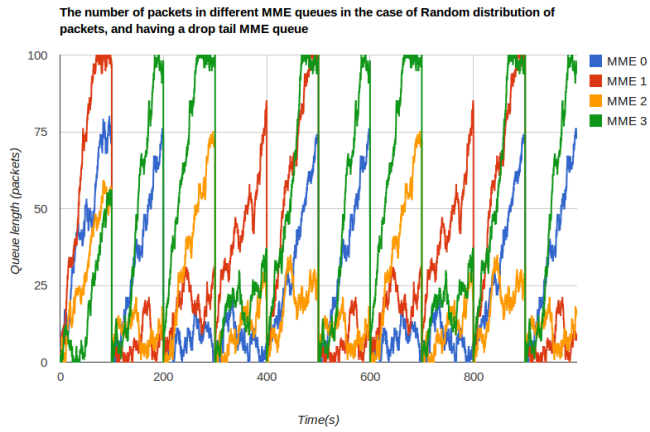

Figure 28: The number of signaling packets in different MME queues for drop tail queue and a random distribution of packets (the case of random traffic with bursts)

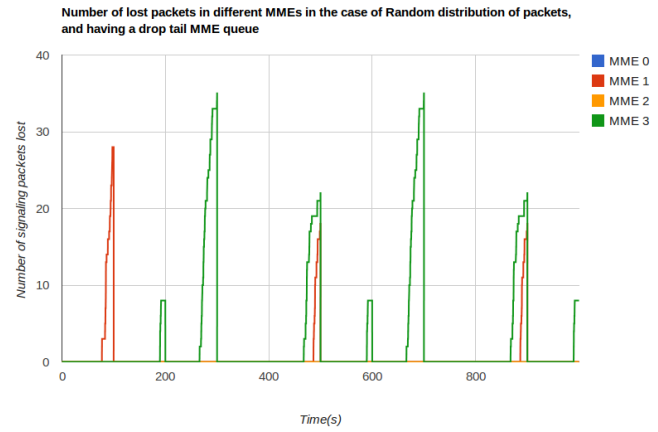

Figure 29: The number of signaling packets lost in different MME queues for drop tail queue and a random distribution of packets (the case of random traffic with bursts)

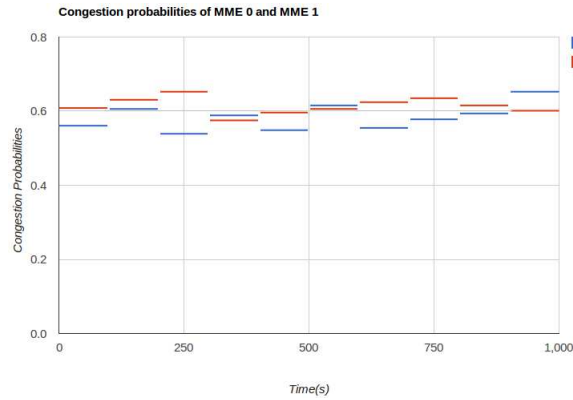

Figure 30: Congestion probabilities of MME 0 and MME 1 (the case of random traffic with bursts)

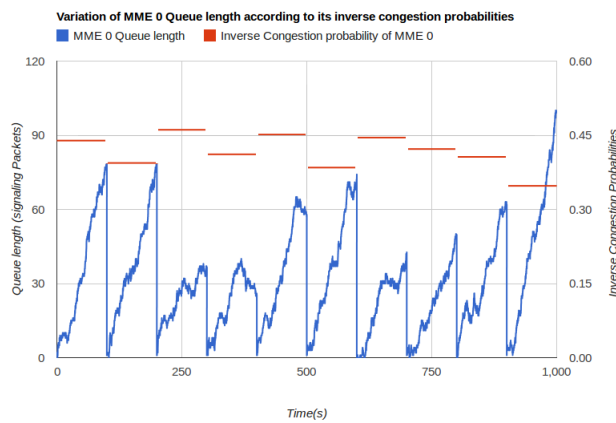

Figure 31: The MME 0 Queue length according to its congestion probabilities (the case of random traffic with bursts)

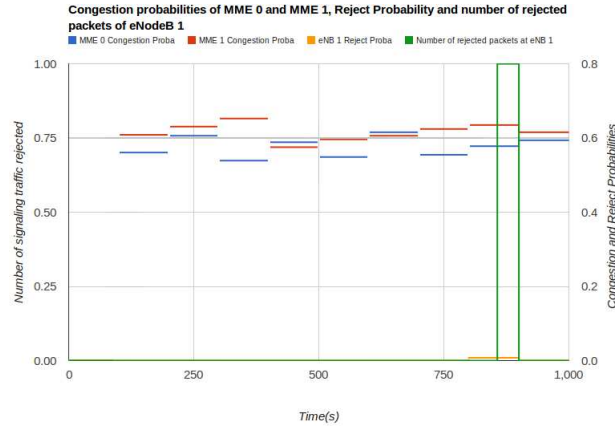

Figure 32: Congestion probabilities of MME 0 and MME 1, Reject Probability and number of rejected packets of eNodeB 1 (the case of random traffic with bursts)

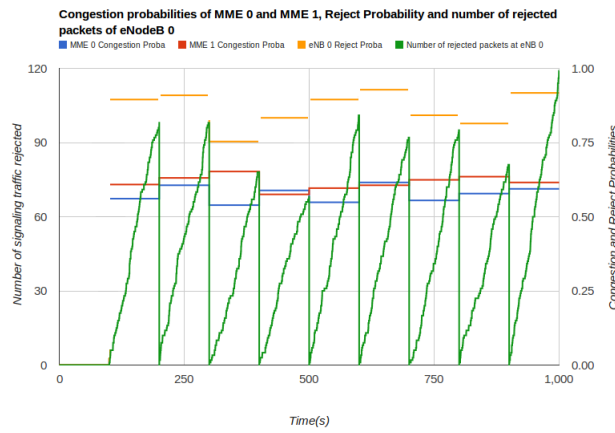

Figure 33: Congestion probabilities of MME 0 and MME 1, Reject Probability and number of rejected packets of eNodeB 0 (the case of random traffic with bursts)

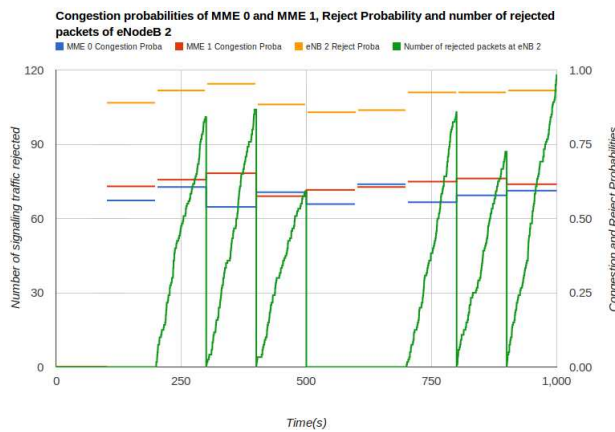

Figure 34: Congestion probabilities of MME 0 and MME 1, Reject Probability and number of rejected packets of eNodeB 2 (the case of random traffic with bursts)

8 Conclusion

M2M applications with their diverse characteristics, namely their enormous generation of traffic (because of the massive number of devices which frequently sends signaling),

and also their wide range of requirements on mobility, reliability, security and power consumption, cause the challenges of LTE networks. Especially reducing, or completely avoiding congestion issue induced by a considerable number of devices trying to connect to the network, or send data. This is precisely what we emphasize in this report. In fact, one of the most important and active research orientations of mobile cellular networks is to get all possible efficient techniques to meet the requirements of M2M applications, so as to take advantages of their benefits, especially the growth market of M2M communications.

Best works realized so far in the purpose of standardizing the deployment of M2M applications chiefly in LTE and UMTS are those of 3GPP. It mainly deals with the problem of congestion in the core network part to integrate MTC applications by mitigating the congestion. However, their proposed approaches are not detailed. Indeed, they just gave general ways to undertake the congestion problem. Some other works in this area were more oriented toward the side of the radio part of the network, but it seems to be not really efficient because the congestion takes place far more in the MME, S-GW and P-GW nodes.

Our work consists of controlling the congestion at the core network part (MMEs) in the case of LTE networks that have more than one MME connected to each eNodeB. We deal with congestion in two steps. First, we balance the load as much as possible between MMEs to avoid that some MMEs are likely to be overloaded, while others remain underloaded. For this, we proposed an algorithm that balances the load between MMEs by a probabilistic routing of the signaling traffic, according to a defined *Congestion Probabilities*. Second, if the load balancing among MMEs is no longer sufficient from the fact that all MMEs are likely to be congested, we move to the admission control to reduce the traffic at the radio part (eNodeBs). The admission control is done by rejecting the signaling traffic probabilistically according to a defined *Reject Probabilities* (in order to give them another chance to send their requests).

We evaluated the performances of our solution using discrete event simulation. The implementation of our simulator is carried out on C++ language. The obtained results show that the algorithm that we proposed is efficient. In fact, the load among MMEs is balanced, and the amount of signaling is reduced so as to deal with congestion. Moreover, our solution is robust and adapts to the traffic patterns we tested: Uniform and random with bursts.

In prospect, we aim to find a way of setting the $P_{congThresh}$ (Congestion Probability Threshold) and Q_{ref} (Reference queue length) that we respectively set to 0.5 and 100, because, for the time being, we chose their values in an empirical way. Values based on a theoretical approach are more interested, and can enhance our proposal.

Bibliography

- [1] Numerex website. <http://www.numerex.com>.
- [2] 4g: The what, why and when. Tellabs, 2011.
- [3] 3GPP TS 36.413 V9.3.0 (2010-06). Evolved universal terrestrial access network (e-utran), Juin 2010.
- [4] 3GPP TS 23.401 V8.12.0 (2010-12). General packet radio service (gprs) enhancements for evolved universal terrestrial radio access network (e-utran) access, December 2010.
- [5] 3GPP TS 22.368-a20. Service requirements for machine-type communication, 2010.
- [6] Ivo Adan and Jacques Resing. *Queueing Theory*. Department of Mathematics and Computing Science Eindhoven University of Technology P.O. Box 513, 5600 MB Eindhoven, The Netherlands, February 2002.
- [7] Alcatel-Lucent. The lte network architecture, 2009.
- [8] Eitan Altman and Alain Jean-Marie. The loss process of messages in an m/m/1/k queue. In *INFOCOM*, pages 1191–1198, 1994.
- [9] Ahmed Amokrane, Adlen Ksentini, Yassine Hadjadj-Aoul, and Tarik Taleb. Congestion control in the context for machine type communication. *To appear in IEEE International conference on communication (ICC) Ottawa, Canada*, 2012.
- [10] TELENOR ASA. Embedding business and life critical connectivity. <http://www.telenorconnexion.com/>, Online on 2008-10-10 15:18:55, accessed on 2012-01-07.
- [11] Ulrich Barth. 3gpp long-term evolution / system architecture evolution overview. Alcatel, September 2006.
- [12] Inc Cisco Technology. Cisco blogs. <http://blogs.cisco.com/>, Online on 2011-04-06, accessed on 2012-01-07.
- [13] Francois Courau. 3gpp's long term evolution and system architecture evolution projects. 3GPP Evolution LTE and SAE, 2005.
- [14] Suman Das, Harish Viswanathan, and Gee Rittenhouse. Dynamic load balancing through coordinated scheduling in packet data systems. In *INFOCOM*, 2003.

- [15] Derek L. Eager, Edward D. Lazowska, and John Zahorjan. Adaptive load sharing in homogeneous distributed systems. *IEEE Trans. Software Eng.*, 12(5):662–675, 1986.
- [16] Sherihan Abu Elenin and Masato Kitakami. Performance analysis of static load balancing in grid. *International Journal of Electrical and Computer Sciences IJECS-IJENS*, 11(3):170–177, June 2011.
- [17] Bob Emmerson. Perspective-m2m: the internet of 50 billion devices. *European Editor of M2M Magazine*, January 2010.
- [18] Li Hongyan, Du Bai, Suo Long, and Li Jiandong. Scheduling Scheme for Cellular-Based Machine-Type Communication. *China Communications*, 8(1):145–150, 2011.
- [19] Michael E. Houle, Antonios Symvonis, and David R. Wood. Dimension-exchange algorithms for load balancing on trees. In *SIROCCO*, pages 181–196, 2002.
- [20] EnerNOC Inc. M2m communications. <http://www.m2mcomm.com/>, Online on 09-June-2005, accessed on 06-January-2012.
- [21] William Leinberger, George Karypis, and Vipin Kumar. Load balancing across near-homogeneous multi-resource servers. In *Heterogeneous Computing Workshop*, pages 60–71, 2000.
- [22] Zhang Lin¹, Li Xiao-ping², and Su Yuan². A content-based dynamic load-balancing algorithm for heterogeneous web server cluster. *ComSIS*, 7(1), February 2010.
- [23] Andreas Lobinger, Szymon Stefanski, Thomas Jansen, and Irina Balan. Load balancing in downlink lte self-optimizing networks. In *VTC Spring*, pages 1–5, 2010.
- [24] Sam Lucero. Maximizing Mobile Operator Opportunities in M2M. The Benefits of an M2M-Optimized Network . *ABIresearch*, 2010.
- [25] Magnus Lundevall, Birgitta Olin, Jonas Olsson, Niclas Wiberg, Stefan Wänstedt, Jonas Eriksson, and Frida Eng. Streaming applications over hsdpa in mixed service scenarios. In *VTC Fall (2)*, pages 841–845, 2004.
- [26] Andreas Maeder, Peter Rost, and Dirk Staehle. The Challenge of M2M Communications for the Cellular Radio Access Network. *11th Würzburg Workshop on IP: Joint ITG and Euro-NF Workshop "Visions of Future Generation Networks" (EuroView2011)*, 2011.
- [27] Shahzad Malik. Dynamic load balancing in a network of workstation. *95.515 Research Report*, 19 November 2000.
- [28] Paul L McEntire, John G O'Reilly, and Robert Edward Larson. Distributed computing: Concepts and implementations. *New York: IEEE Press*, 1984.
- [29] Rajeev Motwani and Prabhakar Raghavan. Randomized algorithms. *ACM Comput. Surv.*, 28(1):33–37, 1996.

- [30] Philippe NAIN. *BASIC ELEMENTS OF QUEUEING THEORY Application to the Modelling of Computer Systems*. University of Massachusetts, Amherst, MA, January 1998.
- [31] Jamal Nazzal, Al-Karaki, and Ahmed E. Kamal. Routing techniques in wireless sensor networks: A survey. *Wireless Communications, IEEE*, 11(6):6–28, December 2004.
- [32] Sudeep Palat and Philippe Godin. Lte the umts long term evolution: From theory to practice. *Wiley publishing edition*, February 2009.
- [33] Barbara Pareglio. Machine to machine communications. ETSI TC M2M Workshop, Octobre 2011.
- [34] Barbara Pareglio. Etsi world class standards: Overview of etsi m2m architecture, Octobre 2011.
- [35] Gottfried Punz. *Evolution of 3G Networks, The Concept, Architecture and Realization of Mobile Networks Beyond UMTS*. SpringerWienNewYork+, year = 2010.
- [36] Hendra Rahmawan and Yudi Satria Gondokaryono. The simulation of static load balancing algorithms. *CS213 Parallel and Distributed Processing Project Report*, 2009.
- [37] Moray Rumney. Lte and the evolution to 4g wireless: Design and measurement challenges. *Wiley publishing edition*, May 2009.
- [38] Silvia Schmidt. M2m communication technologies. <http://www.mc-technologies.net/>, Online on 13-Aug-2002, accessed on 18-Jan-2012.
- [39] Sanjay Shakkottai and A Stolyar. Scheduling algorithms for a mixture of real-time and non-real-time data in hdr. In *in In Proceedings of ITC-17*, page 793–804, September 2001.
- [40] Sandeep Sharma, Sarabjit Singh, and Meenakshi Sharma. Performance analysis of load balancing algorithms. *academy of science, engineering and technology, issue 38*, pages 269–272, February 2008.
- [41] Shiann-Tsong Sheu and Chih-Chiang Wu. Dynamic load balance algorithm (dlba) for iee 802.11 wireless lan. *Tamkang Journal of Science and Engineering*, 2(1):45–52, 1999.
- [42] Kamal Deep Singh, Adlen Ksentini, and Baptiste Marienval. Quality of experience measurement tool for svc video coding. In *ICC*, pages 1–5, 2011.
- [43] Suyash Tripathi, Vinay Kulkarni, and Alok Kuma. *LTE E-UTRAN and its Access Side Protocols*. Radisys White Paper, September 2011.
- [44] Ulrich Türke and Michael Koonert. Advanced site configuration techniques for automatic umts radio network design. *Proc. Vehicular Technology conference VTC 2005 Spring*, 3:1960–1964, Stockholm, Sweden, May 2005.

- [45] 3GPP TS 22.368 v10.1.0 (2010-06). Service requirements for machine-type communications (mtc), June 2010.
- [46] 3GPP TS 22.278 v9.2.0 (2008-12). Service requirements for the evolved packet system (eps), December 2012.
- [47] Harish Viswanathan and A Lucent. Expanding the Role of the Mobile Network Operator in M2M. *ETSI TC M2M Workshop*, October 2010.
- [48] Hao Wang, Lianghai Ding, Ping Wu, Zhiwen Pan, Nan Liu, and Xiaohu You. Dynamic load balancing and throughput optimization in 3gpp lte networks. In *IWCMC*, pages 939–943, 2010.
- [49] Hao Wang, Lianghai Ding, Ping Wu, Zhiwen Pan, Nan Liu, and Xiaohu You. Dynamic load balancing in 3gpp lte multi-cell networks with heterogenous services. *International Science and Technology Cooperation Program (Grant 2008DFA12090) and National Communication Research Laboratory Program (2009A02), China*, 2010.
- [50] David S. Watson, Mary Ann Piette, Osman Sezgen, Naoya Motegi, and Laurie Ten Hope. Machine to machine (m2m) technology in demand responsive commercial buildings. In *ECEEE press, editor, ACEEE Summer Study on Energy Efficiency in Buildings: Breaking Out of the Box*, pages 22–27, August 2004.
- [51] Roy D. Williams. Performance of dynamic load balancing algorithms for unstructured mesh calculations. *Concurrency - Practice and Experience*, 3(5):457–481, 1991.
- [52] Zhong Xu and Rong Huang. Performance study of load balancing algorithms in distributed web server systems. *International Conference on Electrical Engineering and Informatics, Malaysia*, 2004.
- [53] Zhong Xu, Rong Huang, and Laxmi N. Bhuyan. Load balancing of dns-based distributed web server systems with page caching. In *ICPADS*, pages 587–594, 2004.
- [54] Belabbas Yagoubi and Yahya Slimani. Dynamic load balancing strategy for grid computing. *World Academy of Science, Engineering and Technology*, 2006.
- [55] Y.Wang and R. Morris. Load balancing in distributed systems. *IEEE Trans. Computing*, C-34(3):204–217, March 1985.
- [56] Mohammed Javeed Zaki, Wei Li, and Srinivasan Parthasarathy. Customized dynamic load balancing for a network of workstations. *J. Parallel Distrib. Comput.*, 43(2):156–162, 1997.