



HAL
open science

Cost-benefit analysis of the greenhouse gases mitigation options in livestock Case study: anaerobic digesters in pig and dairy farms in the USA and Vietnam

Cindy Schoumacher

► **To cite this version:**

Cindy Schoumacher. Cost-benefit analysis of the greenhouse gases mitigation options in livestock Case study: anaerobic digesters in pig and dairy farms in the USA and Vietnam. Sciences agricoles. 2012. dumas-00758839

HAL Id: dumas-00758839

<https://dumas.ccsd.cnrs.fr/dumas-00758839>

Submitted on 29 Nov 2012

HAL is a multi-disciplinary open access archive for the deposit and dissemination of scientific research documents, whether they are published or not. The documents may come from teaching and research institutions in France or abroad, or from public or private research centers.

L'archive ouverte pluridisciplinaire **HAL**, est destinée au dépôt et à la diffusion de documents scientifiques de niveau recherche, publiés ou non, émanant des établissements d'enseignement et de recherche français ou étrangers, des laboratoires publics ou privés.



Agrocampus Ouest

65 rue de Saint Briec

CS 84215

35042 Rennes Cedex

Tel.: +33 (0)2 23 48 50 00



**Food and Agriculture Organization
of the United Nations**

Viale delle Terme di Caracalla

00153 Rome, Italy

Tel.: +39 0657051

Master's thesis

Engineer degree from the High Education College of Agricultural,
Agri-food, Horticultural and Landscape Sciences

College year : 2011-2012

Major : Politiques et Marchés de l'Agriculture et des Ressources (POMAR)

Cost-benefit analysis of the greenhouse gases mitigation options in livestock

Case study: anaerobic digesters in pig and dairy farms in the USA and Vietnam

By Cindy SCHOUMACHER

To fill by the teacher responsible for the major

Last version

Or by his representative

Date: / / ; Signature:

Permission to distribute: yes no

Before the board of examiners: **Philippe Le Goffe**

Defended at Rennes (FRANCE)

Pierre Aourousseau

Defended on September 11th, 2012

Under the presidency of: **Philippe Le Goffe**

Supervisor: **Benjamin HENDERSON**

Supervising teacher: **Philippe LE GOFFE**

“The analysis and the conclusions of this student work involve only the responsibility of its author
and not the one of Agrocampus Ouest”

Table of contents

List of figures.....	i
List of tables.....	ii
Acknowledgments.....	iii
Acronym	iv
Introduction.....	1
I. Literature review	2
A. The greenhouse gases (GHGs) in livestock.....	2
a. Background.....	2
b. Livestock GHGs emission trends	6
c. Legislation for GHGs emissions.....	7
B. Mitigation options	8
a. Interaction between mitigation options and GHGs emissions.....	8
b. Choice of the studied technologies to reduce manure GHGs	14
c. Anaerobic digestion.....	15
C. Costs of anaerobic digesters and technical and economic feasibility assessment	18
a. Costs and cost-effectiveness	18
b. Technical and economic feasibility assessment	21
D. MAC curves' usefulness: information given by these curves	21
II. Methodology and results	22
A. Model constructed for this study	22
a. The baselines	23
b. Evaluation of the mitigation options.....	23
c. Building the MAC curves.....	27
d. Assumptions	27
B. Geographical scope and technologies considered in the study.....	29
a. Example among the developing countries	29

b.	Example among the developed countries	31
C.	Data research and results	33
a.	Data used in this study	33
b.	Data sources and application of the model	33
D.	Sensitivity analysis and more details about the model done in this study	42
a.	Distribution of the digester: the 1/n assumption.....	43
b.	The discount rate.....	52
c.	Sensitivity analyze of the break-even price P.....	54
d.	Distinction between small and large farms in the USA.....	55
e.	Progressive adoption rate.....	56
III.	Discussion.....	57
A.	Focusing on manure	57
B.	Suitability of the data found	57
C.	Next steps	59
	Conclusion	60
	Bibliography	61
	Appendix I: GHGs origins	I
	Appendix II: GHGs emissions calculation.....	II
	Appendix III: Annex B of the Kyoto Protocol.....	III
	Appendix IV: Comparison of the GHGs mitigation potential between 3 options in Thailand over time	IV
	Appendix V: Anaerobic digestion mechanism	V
	Appendix VI: Components of an anaerobic digestion system	VI
	Appendix VII: AgSTAR.....	VII
	Appendix VIII: Results of the cost study.....	VIII
	Appendix IX: MAC curves examples.....	IX
	Appendix X: Annuity factor and break-even price.....	X

Appendix XI: Description of the Vietnamese digesters.....	XI
Appendix XII: Details about the digesters in the USA	XV
Appendix XIII: Consequences of the change of the capital cost (with the inflation rate) in the USA (above) and Vietnam (below)	XVIII
Appendix XIV: USEPA (2006) results for the USA and Vietnam before tax.....	XIX
Appendix XV: Cost-benefit analysis for a covered lagoon in a 940 pig farm (Payback method)....	XXI
Appendix XVI: Inventory and digesters distribution in the USA.....	XXII
Appendix XVII: Climate zones in the USA and the digesters distribution	XXV
Appendix XVIII: Methodology used for the geographic distribution study.....	XXVI
Appendix XIX: Vietnamese regions and comparison of 3 regions.....	XXVIII
Appendix XX: Picture of a failed lagoon.....	XXIX
Appendix XXI: Comparison of the MAC curves under 2 implied adoption rate assumptions in Vietnam.....	XXX
Appendix XXII: Financial analysis for Vietnamese digesters	XXXI
Appendix XXIII: Effect of the change in the discount rate in Vietnam (10% above, 13% below)	XXXII
Appendix XXIV: Methodology for the MAC curves building while taking into account a progressive adoption rate (5 or 10%) and extract of the break-even price calculation (10% rate)	XXXIII
Appendix XXV: AgSTAR assumption test (500 cows, 2000 pigs).....	XXXV

List of figures

Figure 1: Nitrification/denitrification process.....	3
Figure 2: Benefits of the anaerobic digestion.	17
Figure 3: Methods to assess the economic feasibility of a project.....	21
Figure 4: Abatement potential calculation	23
Figure 5: Regional emission reduction potential	24
Figure 6: Profit equation	24
Figure 7: Electricity revenue-savings calculation.....	25
Figure 8: Break-even price with annual parameters and before tax.....	26
Figure 9: Explanation of the annuity factor calculation.....	26
Figure 10: Break-even price after tax	26
Figure 11: Cost share for the Vietnamese technologies.....	31
Figure 12: Cost share for the USA technologies.....	32
Figure 13: Results of this study for the USA.....	36
Figure 14: Comparison MAC curves before tax with the abatement potential relative to the total baseline (blue) and relative to the manure CH ₄ baseline (orange) in the USA.....	37
Figure 15: Results of this study for Vietnam	38
Figure 16: Comparison MAC curves from this study before tax with the abatement potential relative to the total baseline (blue) and relative to the manure CH ₄ baseline (orange) in Vietnam.....	38
Figure 17: Results of this study after tax USA (left) – Vietnam (right)	39
Figure 18: Individual and total abatement potential	41
Figure 19: Individual and total abatement potential	42
Figure 20: Share of each kind of digester in the US farms	43
Figure 21: Share of each kind of digester in the Vietnamese farms	44
Figure 22: Comparison observed share- 1/n distribution for each technology in the USA	45
Figure 23: Comparison observed share- 1/n distribution for each technology in Vietnam	46
Figure 24: Comparison of the MAC curves under 3 scenarios in the USA.....	50

Figure 25: Present value.....	52
Figure 26: Effect of the discount rate change in the USA (model left, change discount rate right)	53
Figure 27: Cost-effectiveness of the digesters in the little (left) and large (right) dairy farms.....	55
Figure 28: Effect of the application rate in the USA (left) and Vietnam (right).....	56

List of tables

Table 1: Enteric emissions mitigation options.....	9
Table 2: Manure emissions mitigation options	10
Table 3: The biogas recovery systems (or anaerobic digesters)	16
Table 4: List of the USEPA (2006) assumptions tested in this study	29
Table 5: List of the data requested in the model	33
Table 6: Dairy digester spread among states	48
Table 7: Swine digesters spread in the USA.....	48
Table 8: Geographic share of the digesters in the USA.....	49
Table 9: Effects of the change of each one of the parameters in the break-even price calculation	54

Acknowledgments

I would like to thank my supervisor, Benjamin Henderson, for his time, patience and help for this project. Thank you for having giving me the possibility to work on a great subject that combines economics and environment, and the opportunity to discover the “FAO world”. I also wanted to thank Pierre Gerber for having accepted my internship request, Daniel Pambudi for his help about some economic problems, Carolyn Opio and Michael Macleod for their help and data communication.

Thank you also to Robert Beach, Senior Research Economist at RTI international, for his answers to the many questions I had about the model he contributed to build. A huge thank you to Angela McEliece, environmental consultant at RCM international who had the patience and took the time to give me many cost estimates for some digesters in the USA. Thank you also to Felipe R. Montes, from Penn State University, William Lazarus, Professor and Extension Economist at the University of Minnesota, Curt Gooch, Dairy Environmental Systems and Sustainability Engineer at Cornell University, Jennifer Lynn Pronto, Research support specialist at Cornell University, Allan Stocks, Director of the Environmental Programs at the National Pork Board, Doug Young, Spruce Haven Farm and Research Center, and Jerry Bingold, Director Renewable Energy at the Dairy Management Inc. Innovation Center for U.S. Dairy, for their help during my data research in the USA.

I wanted also to thank Louis Bockel from FAO, Tina Amusa from the Asian Development Bank, Pham Van Thanh, director of the Center for Community Health Research and Development in Vietnam, Nguyen Vo Chau Ngan, lecturer at the Department of Environmental Engineering at the College of Environment and Natural Resources in Cantho University in Vietnam, and Matthew Carr, advisor Renewable Energy at SNV Vietnam, for their huge help during my data research in Vietnam. Without them, the Vietnam part of this study would not have been possible.

And finally, thank you to Philippe Le Goffe, my supervising teacher for his follow up for this internship.

Acronym

ASEAN: Association of Southeast Asian Nations
BSE: Bovine Spongiform Encephalopathy
CDM: Clean Development Mechanism
COD: Chemical Oxygen Demand
EU: European Union
FAO: Food and Agriculture Organization of the United Nations
GDP: Gross Domestic Product
GHG: Greenhouse gas
GWP: Global Warming Potential
HDPE: High Density Polyethylene
IPCC: Intergovernmental Panel on Climate Change
IRT: Investment Return Time
KES: Kenyan Shilling
kWh: Kilowatt hour
lb: Pound
MAC: Mitigation Abatement Cost
MICCA: Mitigation of Climate Change in Agriculture
MtCO₂eq: Metric ton CO₂ equivalent = ton CO₂ equivalent (tCO₂eq)
MMtCO₂eq: Million metric ton CO₂ equivalent = 10⁶MtCO₂eq
MWh: Megawatt hour
NASS: National Agricultural Statistic Service
NRCS: Natural Resources Conservation Service
OM: Organic Matter
Ppbv: part per billion by volume
PTD: Plastic Tube Digester
UK: United Kingdom
UNECE: United Nations Economic Commission for Europe
UNFCCC: United Nations Framework Convention on Climate Change
USDA: United States Department of Agriculture
USEPA: United States Environmental Protection Agency
USA: United States of America
VFA: Volatile Fatty Acids

Introduction

Since a couple of years, thanks to the creation of the United Nations Framework Convention on Climate Change and the Kyoto Protocol, concerns have been developed about the need to reduce the greenhouse gases emissions, whose amount increased, to fight against climate change. These gases have many sources but the role of agriculture is especially significant as is the potential to reduce its CO₂ and non-CO₂ (such as CH₄ and N₂O) emissions. Indeed, 63% of the world's anthropogenic non-CO₂ emissions (84% of the N₂O and 52% of the CH₄ generated) [USEPA a, 2006] and 10-12% of all GHGs anthropogenic emissions [IPCC, 2007] were generated by agricultural activities in 2005, and as the population continues to increase, we expect that the contribution of agriculture to climate change will not decrease unless measures be taken. Livestock contributes to 39% of the world's non-CO₂ greenhouse gas (GHG) emissions (2005), whose 7% from manure [IPCC, 2007]. Animal and their excreta are the principal agricultural methane source and most of the N₂O comes from the field and animal house. Thus, within agriculture, livestock is one important source of GHGs. Many international organizations, programs, researchers, politicians tried to find the best mitigation options from agriculture. It is also the case for FAO, which is actively working on the livestock sector to find solutions to decrease the impact of agriculture on the environment and especially on climate change. More specifically, the Mitigation of Climate Change in Agriculture (MICCA) Program has been created in 2010. This program, funded by Germany, Finland and Norway, tries to improve the livelihood of small farmers in developing countries, while proposing solutions to these farmers to decrease the GHGs emissions. The aims are also to estimate the GHG emission sources in agriculture and the mitigation potential of different management practices within farming systems, their economic implications and the factors the policymakers have to take into account while building new policies about climate change. One of the most effective mitigation options from manure is the use of anaerobic digesters in hog and dairy farms. This technology can capture methane and convert it in biogas, which can be used to generate heat and electricity. Thus, the GHGs emissions can be reduced directly and indirectly by decreasing the amount of fossil fuel used to generate the electricity.

There are many types of anaerobic digester technologies. They also differ between developed and developing countries. In this study, we firstly explore what could be the GHGs abatement potential of these technologies, and secondly which technology could be the most cost-effective in the USA and Vietnam. Marginal Abatement Cost (MAC) curves are built to answer to these questions, and according to the sensitivity of the model to some parameters, we can analyze what could be the key factors policymakers have to take into account in future climate change policies. Then, the effectiveness of a model applied at a country level can be tested, the same way the effectiveness of a global model can be tested at the international level. This study can thus support the FAO MICCA project.

We begin with a literature of GHGs and their mitigation options in a global scale to explain the current state of the greenhouse gases emissions and why we chose to focus on manure emissions and anaerobic digesters. Then, an economic model will be built to construct MAC curves about the anaerobic digesters in the USA and Vietnam, according to the available data in 2010, and test some assumptions including those used by USEPA (2006) in a similar study. The results will be finally discussed to point out some limitations of the analysis and future improvements.

I. Literature review

A. The greenhouse gases (GHGs) in livestock

a. Background

GHGs have many sources (energy, industry, agriculture, waste, see Appendix I). In 2005, 5 developing regions, including South and East Asia, Latin America and Caribbean, Sub-Saharan Africa, were responsible for the $\frac{3}{4}$ of the total agricultural emissions [IPCC, 2007]. Agricultural GHGs will increase over the next 20 years especially in Asia (particularly from livestock), Africa (which have the highest emission growth) and Latin America (because of the high exportation and deforestation). Because of population growth, more products are demanded, the diet is changing (more meat (5% increase until 1997, probably 57% in 2020 especially in South Asia and Africa [IPCC, 2007]) and dairy products), and the technologies, the public policies, the prices and costs are changing too. Developing countries emit more GHGs than developed countries, but methane emissions from manure were higher in developed countries up to 2005 [USEPA b, 2006]. West Europe is supposed to be the only region where the GHGs emissions should decrease in 2020, thanks to the climate and environmental policies and the economic constraints on agriculture [IPCC, 2007]. Compared with the 2000 level, the four main non-CO₂ emission sources which are agricultural N₂O, enteric livestock CH₄, manure CH₄ and N₂O, and rice CH₄ could increase by 37%, 30%, 24% and 22% until 2020, respectively [USEPA a, 2006]. Ruminants are the main livestock CH₄ producers because of their special digestive system.

Housed animals can produce slurry (feces, urine, feed residues, bedding material, and water [Van der Meer, 2008]) and manure, in other words liquid manure and solid manure, which can give nutrients to plants, but also generate GHGs. These gases include nitrous oxide (N₂O), methane (CH₄), ammonia (NH₃, which is a precursor to N₂O), which are much more effective than CO₂ at trapping heat because they have a higher global warming potential (GWP¹). Their amount can be measured thanks to several techniques (see Appendix II). Most of these GHGs emitted from manure are CH₄ emissions which come from swine and dairy cattle, because their manure is typically managed in liquid under anaerobic conditions. The other species emit less because they are either on pasture (non-dairy ruminants) or housed with dry litter systems (poultry) with solid manure deposited in aerobic conditions [USEPA a, 2006, Rigolot *et al.*, 2010]. This statement may be opened to debate because other studies indicate that liquid manure emits twice less GHGs than solid manure, because of the high levels of N₂O emitted from this latter. As manure is an important source of GHGs and because many benefits can be obtained from this mitigation (see B.a. and B.c.), it is the focus of this study.

¹ The GWP enables us to compare the ability of the GHG to trap the heat in the atmosphere. CO₂ is the reference and the calculation of this GWP is based on 100 years. Thus CH₄'s GWP is 23 and N₂O's GWP is 296. With this "unit", we can convert the non-CO₂ emissions into CO₂ equivalent units. Here we will only present the GHGs that come from agriculture (and not the high GWP gases that come from industry). [IPCC b, 2001]

i. Nitrous oxide (N₂O)

This gas can remain for about 114 years in the atmosphere (CO₂ has a lifetime of 100 years) and has a heat trapping effect 296 times higher than CO₂ (100 years of time horizon) [IPCC b, 2001]. Thus, it has an important impact on global warming and on the ozone depletion in the stratosphere (conversion of N₂O in NO). N₂O can be produced naturally (about 60% of the N₂O emissions on a global basis [IPCC a, 2001]), especially from biological sources in soil and water, and by humans through agricultural soil and livestock waste management (65% of the anthropogenic N₂O [FAO, 2006], but Kroeze (1998) explained that the contribution of N₂O from the animals is not really known and could be negligible at national scale [Monteny *et al.*, 2001] because of the anaerobic character of slurry that prevents nitrification), mobile and stationary fossil fuel combustion, adipic and nitric acid production (main manmade sources in the USA). Once in the atmosphere it can be removed by photolysis in the stratosphere. The atmospheric concentration of N₂O increased by 16% between 1750 and 1998 (314 ppbv). Nowadays the increase rate is 0.25% per year. [USEPA a, 2006]

N₂O is produced by nitrification (aerobic)/denitrification (anaerobic, no oxygen) from soil after manure spreading, livestock bedding, solid manure stores, and stored slurry (figure 1).

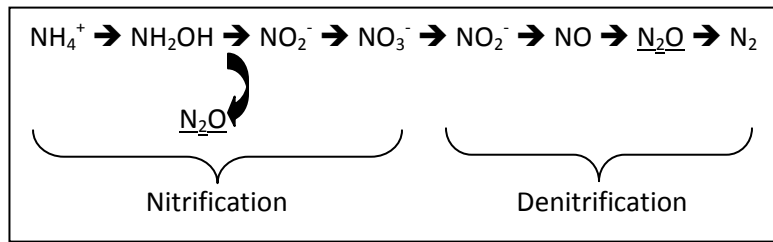

Figure 1: Nitrification/denitrification process

The ammonification of urea from urine creates ammonium NH₄⁺, which will be subject to aerobic conditions. So, nitrification occurs and produces nitrate (NO₃⁻) for denitrification. A delay can be observed between manure application and N₂O emission because of mineralization/nitrification and the sufficient NO₃⁻ creation. The emission factor (between 0.1 and 3% [Chadwick *et al.*, 2011]) depends on the soil type and conditions, the manure composition, the measurement period, the type of bacteria involved in the process, and the amount of oxygen and liquid in the manure system. Immediate N₂O emissions following manure application can occur because of a source of NO₃⁻ within the manure, or the denitrification of residual soil NO₃⁻. But, no N₂O will be produced in the short and medium term from the organic form. Within 48 hours, a large amount of N volatilizes as NH₃ after manure spreading, which decreases the quantity available for N₂O production. So the readily available N drives N₂O emissions.

The key management decisions that have an impact on N₂O emissions after spreading are:

- Manure type: dairy slurry leads to higher emissions than pig slurry (not the same C content and presence of fine solids in the dairy slurry blocking soil pores which creates anaerobic conditions).
- Soil type: a clay soil after manure application leads to higher emissions (different water capacity, organic matter (OM) content and cation exchange capacity) [Chadwick *et al.*, 2011]. The source of N₂O in this soil is denitrification, while the one in a sandy loam soil is nitrification [Rochette *et al.*, 2008]

- Timing of manure application (temperature, soil water): After autumn/winter slurry application, a higher quantity of N lost as NO_3^- can be found because slurry applied to actively growing crops during spring creates a bigger N sink. If water content of the surface layer reduces, then N_2O emissions will increase. [Chadwick *et al.*, 2011]
- Manure application rate: optimizing the rate, timing and technique of manure application could reduce losses of direct (higher rates lead to more N_2O losses) and indirect N_2O (via O_2 depletion of the soil, which increases denitrification). [Van der Meer, 2008]
- Application method: broadcasting across the surface or slurries injected into the soil. Shallow injections (reduce the contact with the air) can reduce 73% and 23% of the NH_3 emissions when applied to grassland and arable land respectively, but increase N_2O emissions [Misselbrook *et al.*, 2002]. If the conditions are not good enough for denitrification, injection can reduce NH_3 emissions without increasing N_2O one. [Chadwick *et al.*, 2011]
- Slurry treatment: soils treated with digested slurries could lead to lower emissions than from untreated slurries, but it depends on soil properties (for example the redox potential) and on application conditions [Chadwick *et al.*, 2011].

Moreover, studies mentioned by Chadwick *et al.* in 2011 show that the absence of bedding or the presence of hard standing areas enable slurry to stay in anaerobic state which prevents nitrification and so no or little N_2O emissions will occur. Higher emissions will occur from deep litter systems with fattening pigs. Slurry stores create anaerobic conditions. Thus, N_2O production from slurry manure with no surface cover is negligible (no nitrification). Some materials used to cover liquid manure stores to prevent ammonia emissions enhance crust formation (aerobic conditions), which leads to an increase in N_2O emissions.

Finally, solid manure stores provide aerobic and anaerobic conditions. They are a source of N_2O production, consumption and emission (which release usually between less than 1% and 4.3% of the total N). Thorman *et al.* in 2006 showed that between 0.2 and 0.8% of total heap N is lost as N_2O from stored poultry manure and covering these heaps reduces NH_3 emissions but has no effect on N_2O . However, covering the heaps and compacting the manure create anaerobic conditions that can reduce N_2O and NH_3 emissions from solid manure heaps [Chadwick *et al.*, 2011].

ii. Methane (CH_4)

Its lifetime in the atmosphere is 12 years and its GWP is 23 times higher than CO_2 (100 years time horizon) [IPCC b, 2001]. CH_4 comes from landfills, natural gas and petroleum systems, coal mining, agriculture, combustion, wastewater treatment, and industrial processes [USEPA a, 2006]. The livestock sector emits 37% of the world anthropogenic CH_4 [FAO, 2006]. 10% of the digestible feed intake or 5.5% of the gross energy intake will become CH_4 for ruminants. For pigs and poultry it is far less than that (0.6% of gross energy for sows [Jorgensen *et al.*, 2011]). The type of feed, the production level (beef cattle versus dairy cows) and the age (calves versus dairy cows) have a great impact on CH_4 emission levels [Monteny *et al.*, 2001].

o Enteric CH_4

The enteric fermentation occurs in the stomach/rumen of the ruminants (major emitters) and in the colon of the pigs (less CH_4 produced because the capacity for this production is lower) where microbes in animal's digestive system ferment food [USEPA a, 2006]. This is the most important

source of CH₄ in dairies (80%) whereas fermentation of manure is the most important source of CH₄ for pig and poultry farms (70%) [Monteny *et al.*, 2006]. If the increase of CH₄ is proportional to the increase in livestock number, then the CH₄ production from livestock should increase by 60% in 2030, but changes in the feed and manure management could improve the situation [IPCC, 2007]. Concerning beef cattle, non lactating cows like heifers produce less CH₄ per day than steers because the latter have higher daily feed intake. But their higher growth rate leads to 20% less CH₄ produced during the whole production period. The cattle on pasture can emit more CH₄ if the grass quality is poor and if their level of performance is low [Clemens *et al.*, 2001]. The fermentation occurs in two steps: the fast growth of acidogenic bacteria (optimum at 30°C), which produces organic acids, H₂ and CO₂, and the specific methanogenic bacteria work, which produces CH₄ from organic acids [Monteny *et al.*, 2006]. Enteric fermentation is responsible for 80% of the CH₄ emission from cattle houses and 35% (mainly from indoor) for pig's houses in the Netherland (72%, 23%, 1,3% of the CH₄ emissions from enteric fermentation came from beef cattle, dairy cattle, and swine respectively in the USA in 2000 [USEPA, 2012]). [Monteny *et al.*, 2001]

- Manure CH₄

Manure stores are also a major source of CH₄. If manure is stored or treated in anaerobic conditions (e.g. as liquid or slurry in lagoons or tanks), its decomposition will produce CH₄. Preventing anaerobic conditions could therefore decrease CH₄ production. As mentioned, if manure is solid or deposited on pasture for example, there will be an aerobic decomposition and little CH₄ production. Liquid system use is higher in dairy and swine farms in industrialized countries and in newly industrializing countries in Asia and Latin America [USEPA a, 2006].

CH₄ flux is positively correlated with slurry temperature, and it tends to increase above 15°C [Chadwick *et al.*, 2011]. This CH₄ source is influenced by the composition of the manure which depends on the animal type and diet. If the feed contains a lot of energy, there will be more CH₄ produced. But some higher-energy feeds are more digestible than lower energy feeds, so less waste will be excreted from the animal [USEPA a, 2006]. A lot of studies have been done to determine the factors that affect CH₄ production, which is influenced by management and environmental factors like the temperature, the biomass composition, the manure management, the duration of the indoor or outdoor storage, the percentage of volatile solids, pH, water content, or the substrate availability [Chadwick *et al.*, 2011]. This production depends also on the rate of organic matter fermentation, the type of volatile fatty acids produced (if their production increases and if pH decreases, there will be more production of propionate which is an alternative to the production of CH₄), and the efficiency of microbial biosynthesis. As CH₄ is not soluble, it will easily volatilize [Monteny *et al.*, 2006]. CH₄ comes also from the anaerobic digestion of slurry stored indoor and outside, and more specifically from the hydrolysis of hemicelluloses. Temperature and storage are the most important parameters that determine the amount of CH₄ produced [Monteny *et al.*, 2001].

Diet and animal type (age and the weight) have an impact on CH₄ emissions [Monteny *et al.*, 2001]. CH₄ production will increase if the organic matter content in the excreta increases. So cattle slurry produces less CH₄ than pig slurry, which produces less CH₄ than poultry manure, but more slurry are produced from cattle so CH₄ emissions from this slurry is higher.

CH₄ is an energy source. The prevention or the capture and then the use of CH₄ emissions can provide energy, economic and environment benefits (see part I.B.c.). A study on air bubbles in glaciers shows that there are more CH₄ now than at any time during the past 400 000 years [USEPA a, 2006]. Since 1750, CH₄ concentration in the atmosphere increased by 150% up to 1745 ppbv in 1998 [IPCC a, 2001], but it is slowing nowadays (with a rate of 20, 9-13, and 0-13 ppbv per year in the late 1970s, 1980s, and 1990s respectively), up to 1751 ppbv in 2002. [USEPA a, 2006]

CH₄ is removed from the atmosphere by sinks. The main one is the oxidation with hydroxide radicals OH (CH₄+OH=CH₃+H₂O) in the troposphere. The same process happens in the stratosphere but with less amount of CH₄ destroyed. Troposphere and stratosphere reactions represent 90% of the CH₄ removal. The other sinks are the microbial uptake of CH₄ in soils (7% of the CH₄ removal) and the reaction of CH₄ with chlorine atoms in the marine boundary layer (<2% of the CH₄ removal) [USEPA a, 2006]. The most effective way to reduce CH₄ emissions during outside storage could be to reduce organic matter content of slurry with a biogas digester (emissions 30 to 66% lower). [Chadwick *et al.*, 2011]

iii. Ammonia (NH₃)

This gas is not considered as a direct GHG, however, it is a precursor to N₂O (direct active GHG) and NO [Clemens *et al.*, 2001]. 65% of all NH₃ emissions from terrestrial systems come from animal farming systems [National Research Council, 2002]. NH₃ comes from the anaerobic digestion of food proteins. In the cow's rumen, the microbes use NH₃ to create proteins. But sometimes, too much NH₃ can be found in the rumen, so it goes into the blood and is excreted with the urine in the urea form. When NH₃ is in the atmosphere, a part of this gas comes back to the ground, which can create environmental problems such as the acidification or changes of the ground structure, and the other part remains in the atmosphere and reacts with some atmospheric acids to create aerosols, which can be a problem for air quality and for animal's and human's health. [McGinn *et al.*, 2007]

b. Livestock GHGs emission trends

The livestock sector has grown fast in recent decades as population growth and increases in per capita incomes have increased demand for livestock products, particularly in developing countries. New technologies, including genetic selection, shift from grazing to feedlot systems, reproductive technologies, increased livestock production in response to the increase in demand. Thus, meat and milk production are projected to double between 2001 and 2050 [FAO, 2006], and this demand could be met especially through an increase in animal numbers in developing countries [Rosegrant *et al.*, 2008]. This increase in livestock number will lead to more GHGs emissions (20% more enteric and manure CH₄ emissions from 2005 to 2020 particularly from China, Latin America, Africa, South Asia, South East Asia...) [USEPA b, 2006]. The amount of emissions depends also on the animal type: beef production emits 13 times more (by output weight) than chicken meat production (because it is less intensive and they have a better feed conversion efficiency), on the regions (beef meat production in Argentina leads to much higher emissions than in the US or in South Korea), and on the production type (meat emits more than milk for example because dairy farms are more efficient at converting feed into food for consumption). Thus, agriculture and livestock contribute to climate change, which has bad impacts on agriculture and grazing livestock systems especially (increases temperature, changes in rainfall, extreme weather) [Henderson *et al.* 2011]. Non grazing livestock,

which stay inside buildings, can better control production conditions [FAO, 2009]. Finally, 70% of the mitigation potential is in the developing countries [McKinsey & Company, 2009], where appropriate policies (climate or non-climate one) will have to be created to reduce the emissions. [Henderson *et al.*, 2011]

c. Legislation for GHGs emissions

CH₄ and N₂O production are regulated by the Kyoto protocol (1997) under the United Nations Framework Convention on Climate Change (UNFCCC). The countries do not have the same emission targets. For example, the USA's target would have been -7% between 2008 and 2012 if they had ratified the protocol [UNFCCC a, no date]. To reach this aim, the countries can create national measures or use three mechanisms: the carbon market (emission trading), the Clean Development Mechanism (CDM, see below) or the Joint implementation (a country from the Annex B of the protocol, see Appendix III, can earn emission reduction credits from a project in another Annex B country). National or international strategies exist to reduce the GHGs directly or indirectly, e.g. In the case of the Nitrates Directive for the protection of the water against NO₃⁻ that comes from agriculture and that could be used for denitrification and produce N₂O. The Gothenburg Protocol (1999) to Abate Acidification, Eutrophication and Ground-level Ozone is included in the Convention on Long-range Transboundary Air Pollution (CLRTAP) and provides abatement options and economic instruments to reduce NH₃ emissions from agriculture. [Chadwick *et al.*, 2011] [UNECE no date]

30 to 50% of the total N₂O emissions from agriculture could come from wastes from animal production systems [Oenema *et al.*, 2005]. The assessment of the percentage of manure N₂O emissions includes manure spreading, manure management in animal housing and stores, and excludes emissions from urine and feces from grazing livestock. This percentage varies from country to country, for example, in the UK and Japan, manure contributes to 16% and 50% of agricultural emissions in 2007 respectively; this difference comes from different use of fertilizer, crop, livestock, or management. Globally, 12 to 41% of the agricultural CH₄ emissions come from manure. Differences in these emissions among countries come from the duration of manure storage, the proportion of ruminant livestock and the extent of rice production and biomass burning [Chadwick *et al.*, 2011]. So, each country needs legislations adapted to their amount of emissions to respect their Kyoto protocol commitments. The manure management legislation in the Netherlands in 2008 forbids to discharge livestock effluent to surface waters (collection and storage of feces and urine) and to apply slurry in the season without plant growth or when the soil is frozen (need storage). The establishment of new livestock farms, the expansion of existing farms in areas with a high livestock density and the application rate of N are restricted [Van der Meer, 2008].

In developing countries the CDM projects are important. It enables some projects, whose aim is to reduce emissions, to earn Certified Emission Reduction (CER) credits and to sell them to developed countries. These countries will then use these credits to meet their emission targets under the Kyoto Protocol. Thus, this mechanism can benefit both developing and developed countries. It allows developing countries to develop new technologies and achieve sustainable development while decreasing their own GHGs emissions, and provides developed countries with more flexibility to meet their commitments under the Kyoto Protocol. A lot of CDM projects exist in China (49.73%), India (19.47%), Latin America or Brazil. On August, 14th 2012, 4464 projects were registered, whose

163 in agriculture (36.2% large scale, 63.8% small scale) [UNFCCC b, no date]. Some countries such as China have introduced many laws and programs under some UN conventions, which can also achieve mitigation benefits related to land use. For example, under the UN Convention on Biodiversity, China created a program to restore croplands close to lakes, sea, or other natural lands as conservation zones for wildlife (this could increase soil carbon sequestration but also CH₄ emissions) [IPCC, 2007].

In many regions, non-climate policies related to macro-economics, agriculture and environment have a higher impact on agriculture pollution mitigation than climate policies. Even if agriculture has good technical potential for mitigation, only little progress has been made to apply these mitigation options because of barriers that cannot be easily overcome [IPCC, 2007].

B. Mitigation options

Many options exist to reduce the GHGs emissions, some of them focus on one GHG, others are efficient only in laboratory experiments, and some are widely studied and discussed in the literature. According to the evidence found in studies about the effectiveness of these mitigation practices, some options will be selected to be compared. While there are some effective measures which reduce the emissions only indirectly, e.g. genetic selection for more efficient animals, these measures are not taken into account, but if they did, they could increase the abatement potential by 2/3 [Moran *et al.*, 2008]. Enteric options will be presented here but not taken into account in the rest of the study.

a. Interaction between mitigation options and GHGs emissions

i. Summary of possible options

Some reviews have been done for GHGs mitigation options. Clemens's study (2001) sets apart the preventive measures, which reduce C and N input or output related to animal husbandry (the best one, according to criteria such as the emission reduction potential, the efficiency of N conversion, or the effect on yield, is animals with a high productivity fed with an optimized diet to reduce CH₄ production), and "end of pipe" measures, which reduces GHGs production from C and N in the system of animal husbandry (the best one is the anaerobic digestion of the manure).

○ Measures to reduce enteric emissions (table 1)

Mitigation options	Comments
Preventive measures for ruminants	
Optimizing the diet (more concentrates, less forages, or improve forage quality)	Can reduce the CH ₄ emissions especially in developing countries (for example, less crude fiber)
High performance animals, herd management	CH ₄ decreases when the product unit increases (for example, lower emission/unit of milk produced)
Anabolic steroids	5-10% reduction of the GHGs emissions
Hormone treatment	Increases milk production by 10-20% and reduces animal stock → reduction of 9% of the CH ₄ emissions in the USA
Increasing the reproductive performance, selecting the individuals for the reproduction	Decrease of the GHGs emissions
Change bacterial flora of the ruminant stomach	
End of pipe measures	No technology available

Table 1: Enteric emissions mitigation options [Clemens *et al.*, 2001]

The anabolic steroid and hormone treatment options can be effective, but they are forbidden in some countries such as Germany, Canada, EU because some residues remain in the final product. As non-ruminants do not emit a lot of enteric emissions, these mitigation options are not relevant for them.

For ruminants, the most effective CH₄ mitigation dietary measures could be the increase of the level of starch or soluble carbohydrate to increase the production of propionate instead of CH₄, the change of the diet (less fiber) to increase the productivity, or the decrease of methanogens. But only the two first solutions are feasible because the third option would lead to the addition of probiotics for example and many consumers are against this. The change of the diet could decrease enteric CH₄ emissions but also change the composition of the manure and thus the greenhouse gases production from this source [Monteny *et al.*, 2006]. Moreover, the use of additives has an effect on rumen microflora population, which could change the fermentation and lead to lower emissions (but some additives, considered as medicines are not allowed in some countries including those in the EU).

So, it appears that among these different options, the change in the diet², the selection of the animals and genetics (better breeding, feeding methods and husbandry can lead to 10-14% less CH₄ emissions from dairy in Germany (30% less CH₄ emissions over the last 40 years in this country) [Clemens *et al.*, 2001]) are efficient and feasible options to reduce the enteric emissions.

² especially in developing countries because in developed countries the diet is already optimized, which can lead to 20% less CH₄ emissions per cow per day but 21% more CH₄ emissions from the total herd if an intensive production system becomes an extensive one with more cows and a restricted diet [Monteny *et al.*, 2006], 20-30% less ammonia emissions according to Powell *et al.* 2008, less N excretion, and other potential benefits according to Chadwick *et al.* (2011) and Oenema *et al.* (2005)

○ Measures to reduce manure GHGs emissions (table 2)

Mitigation options	Comments
Preventive measures	
Reduction of the N output of the excreta	By reducing the animal number for example
Optimizing the diet of the animals	Improve the digestibility which could decrease CH ₄ emissions
Influencing and controlling microbial processes in the excreta	For the non grazing systems so that the excreta can be collected, the grazing systems are uncontrolled
Adding straw to solid manure	Will reduce NH ₃ emissions but could increase N ₂ O emissions; mixing 50% straw with cattle manure at the beginning of the storage reduced CH ₄ and N ₂ O emissions by 45% and 32% [Chadwick, 2011]
Compact farmyard manure	Will reduce NH ₃ but increase CH ₄
Quickly remove the excreta into biogas plant while using a storage in a closed system	Will reduce CH ₄ and N ₂ O emissions (10%) [Monteny <i>et al.</i> , 2001]; in pig houses, emissions can be 40% lower than in houses where channels are not cleared frequently. [Haeussermann, 2006]
Outdoor slurry treatment (combination of aerobic (nitrification) and anaerobic (denitrification) treatment) (example of the Netherland's veal calf)	Could lead to an ammonia free slurry. Between 10 and 20% of the slurry N can be lost as N ₂ O from aerobic slurry treatment. [Monteny <i>et al.</i> , 2001]
Adding lactic acid until pH 4.5	90% less NH ₃ and CH ₄ , decrease of N ₂ O emissions [Monteny <i>et al.</i> , 2001]
Total solid content: at least 18% (more aeration)	Decreases CH ₄ and N ₂ O emissions [Monteny, 2001]
End of pipe measures	
<u>Anaerobic digesters</u>	Improve energy efficiency, can reduce 85% of CH ₄
<u>Housing system and manure storage</u>	
Hot fermentation	Could remove 60% of the N in the liquid manure (reduction of the CH ₄)
A cover placed on the excreta surface or a biofilter	For nitrification of the NH ₃ (but NO ₂ emissions would increase)
Adding gypsum (CaSO ₄) to pig slurry (experiment in Germany [Berg <i>et al.</i> , 2008])	CH ₄ flux decrease linearly with the quantity of added gypsum, no NO ₂ emission detected
<u>Field application</u>	
Influencing the balance NH ₃ -NH ₄ ⁺ (acidification, addition of CaSO ₄ to modify the pH)	No or a few CH ₄ is emitted after land application of the excreta; a solution with a low pH → no NH ₃ emissions
Incorporation of slurry	Reduce NH ₃ but increase N ₂ O emissions
<u>After slurry application</u>	40% of the NH ₄ ⁺ applied with liquid manure reaches the soil microorganisms and is available for the plants (the rest volatilized as NH ₃). These 40% are a potential source of N ₂ O. The injection of liquid manure avoids the NH ₃ volatilization and about 90% of the NH ₄ ⁺ could be available for the soil microorganisms

Table 2: Manure emissions mitigation options [Clemens *et al.*, 2001]

As shown in table 2, there are many mitigation options for manure. For the preventive measures, optimizing the diet for cows while decreasing the crude content and the use of proteins with low degradability in the rumen could decrease the N excretion. For sows and fattening pigs, improving the amino acid content of the diet could also decrease this N excretion (the change in the feeding method could lead to 12% less N excretion [Clemens *et al.*, 2001]). Moreover, composting can lead to lower inorganic nitrogen (available for the plants), lower total carbon concentration, higher dry matter, higher total mass losses (water + dry matter), higher losses of C and N but it allows the transport of up to twice more phosphorus than fresh or stockpiled manure [Larney *et al.*, 2006].

For the “end of pipe” measures, cooling the manure (<10°C), (21% less CH₄ emissions for pig slurry in-house), reducing the pH (with lactic acid), removing manure from indoor storage pits (if a sufficient outdoor storage capacity and other measures to prevent outdoor CH₄ emissions are available), and a better management of the bedding (minimize compaction, add litter, remove regularly) are other CH₄ mitigation options. Nitrification inhibitors can be used to decrease N₂O emissions, the control of nitrification/denitrification is important to have a greater flux of N₂ instead of N₂O (the factors controlling N₂O/N₂ ratio are not perfectly well-known). The interaction between manure and fertilizer nitrate is important for N₂O emissions especially in the Nitrate Vulnerable Zones³.

Anaerobic digestion (which will be detailed below) will first decrease the amount of CH₄ emitted but could also increase the amount of NH₃ available for the plants, have an impact on the quantity of C (the anaerobic digester will use more C for the biomass or for CH₄ production, less C in the slurry will be available for the denitrification), and will reduce the N₂O emissions after land spreading [Monteny *et al.*, 2006]. We can deal with the climate change problem while using CH₄ for energy production (reduce the emissions of CH₄ and CO₂ from fossil fuels). Finally, the use of anaerobic digestion and electrochemical oxidation has been tested for dairy manure in Japan by Ihara *et al.* (2008). Indeed, anaerobic digestion can recover biomass energy and treat animal waste for C recycling but it does not allow much denitrification. Hence the need for electrochemical oxidation of the NH₃ produced, which requires electricity. This study evaluates the feasibility of using electricity created by a biogas plant for the electrochemical oxidation of ammonium nitrogen in anaerobically digested effluent. The author found that 24 to 33% of the electricity required for the electrochemical oxidation can be supplied by the biogas plant, which is not very efficient. But electrochemical oxidation of digested effluent from a biogas plant for dairy manure is a good option for the treatment of NH₄-N. This oxidation and the use of NaCl decrease NH₄-N and COD (by 28.9% for COD and almost 100% for NH₃ after 5h). Indeed, during the indirect oxidation, the electrochemically generated oxidants destroy the pollutants and decrease NH₄-N in the solution. During the direct oxidation, the organic matter is destroyed on the oxide anode by electrochemical conversion or combustion. Indirect oxidation is dominant during electrochemical oxidation of the digested effluent [Ihara *et al.*, 2008].

³ Area of land that have or could have an excess of nitrate (more than the limit 50 mg NO₃/L) and where farmers have to take measures to decrease the NO₃ concentration (less fertilizer use or use it with a better timing, better management of the manure application to land...) otherwise they will have to pay a fine

- Packages of options and interactions between measures

Finally, the use of several mitigation options is feasible. For example in the UK, the use of ionophore, improved genetics and productivity for beef and dairy, and anaerobic digesters for beef, dairy, poultry and pigs could lead to the reduction of 5% of the emissions [Moran *et al.*, 2008]. Moreover, there could be some interactions between enteric and manure emissions. Indeed, the adoption of one option to reduce emissions from one source could also have an effect on other emission sources. The typical example is the change in the diet, which could lead to less enteric emissions but will also change the composition of the manure and thus, could decrease the emissions from this source.

Some options can decrease GHGs but others, in some conditions, can increase them or decrease one of them and increase the others. A study done by De Klein about the N₂O mitigation options in 2008 concludes that nitrification inhibitors, managing animal diets and fertilizer management had the best potential for reducing emissions in the short-term. But some practices could increase CH₄ emissions (practices that increase the efficiency of N in the soil-plant system), so all GHGs need to be taken into account to be sure that the mitigation of one GHG will not lead to the increase of another one. Schils *et al.* (2006) showed that the reduction of N fertilizer used and grazing times could lead to the mitigation of 50% of the N₂O emissions in Dutch dairy farms, but only 26% of the total GHGs emissions will be reduced. Indeed, for example, if N₂O emissions decrease but CO₂ or CH₄ emissions increase, then total GHGs emissions could increase [De Klein *et al.*, 2008].

Dinuccio (2008) made a study about the treatment of the slurry by solid-liquid separation, which creates a nutrient rich solid fraction that can be transported at lower costs to deficit areas. GHGs emissions have been measured during the storage of pig slurry such as the solid and liquid fractions obtained by mechanical separation in laboratory. The study found 7.8% solid and 92.2% liquid produced after the separation. It also shows that this separation, for the solid phase, increases the pH, doubles the total nitrogen, decreases the total ammonia-nitrogen, and leads to higher volatile solids in total solids whereas it is the contrary for the liquid phase. The main GHG emitted from liquid manure (and also for rough slurry) is CH₄ (and then CO₂, and NH₃). N₂O emissions are low during slurry storage (anaerobic conditions). The main GHG emitted from solid fraction is N₂O (and then CO₂ and CH₄) because solid fraction produces a fibrous product, so the air goes into the upper part of the solid fraction samples, where nitrification and denitrification occur. NH₃ and CH₄ emissions are low. So, if we combine solid and liquid, N₂O emissions increase, CH₄ and CO₂ emissions increase by 3% and 10% respectively, NH₃ emissions decrease. In general, GHGs emissions increase by 25%. So, solid liquid separation is not a good option for the environment due to high emissions of CH₄ from the liquid fraction and high emissions of N₂O from the solid fraction [Dinuccio *et al.*, 2008]. But this study has been done from manure of one farm in Europe, so the results are specific to this area. Different results may be found in other agro-climatic conditions.

However, only a few adverse effects have been found for anaerobic digesters. For example, their use could decrease the carbon supply in the soil, which could decrease the organic matter supply, and thus have an effect on the mineral transfer in the soil. Their use could also lead to some issues about the cultivated land for food or energy purposes.

Thus, among these options, the ones that lead to a decrease of one GHG but an increase of another one may not be considered as efficient measures: literature about adding straw leads to different results, in some condition (little amount of straw and litter used which will create wet and dense areas like anaerobic ones), N₂O emissions could increase; the compaction of farmyard manure; slurry incorporation. Moreover, lactic acid is considered as a biochemical pesticide which is strictly regulated and can face consumer opposition and the addition of gypsum has been tested only during an experiment. So these options cannot be considered as feasible either. The efficiency of changing the diet explained before is valid for enteric and manure emissions. The reduction of the animal number is feasible only if their performance and productivity increase. Finally, removing excreta in a biogas plant, treating the slurry and using a cover are options used within the anaerobic digester technology. This method is very detailed in the literature and is well developed in the developing and developed countries (USA, Germany, Vietnam...). Its efficiency can be up to 85% less GHG (CH₄) in the USA for example and the digesters, according to their type and localization, can be quite cost-effective. According to these criteria (environmental, studies and international discussions about this option), the anaerobic digestion, while using a digester, can be one of the best options to reduce the GHGs from manure.

ii. Co-benefits from GHGs manure mitigation options

Land application of livestock manure increases soil OM, C content, soil structure and aeration, water-holding capacity and cation exchange capacity. Thus a good use of manure can improve soil quality and yields. [Van der Meer, 2008]. Increasing on-farm N-use will slow down nitrate loading and eutrophication of surface and coastal water. The use of N more efficiently will decrease the need of fertilizer, and so the quantity of CO₂ emission (because CO₂ is created while producing these fertilizers). Some practices to reduce CH₄ emissions can also improve crop and animal productivity (like changing the diet or improving the animal breeding). Moreover, the use of CH₄ for energy could lead to less expenditure on energy and so could decrease CO₂ emissions. Increasing soil organic matter levels can lead to improved fertility and soil sustainability (better water storage capacity, increased water infiltration, reduced erosion, increased soil buffering capacity and storage of essential plant nutrients) [Paustian *et al.*, 2004]. Composting can lead to less haulage requirement and can remove viable weed seeds, bacteria and human parasites [Lamey, 2006]. It can also reduce the manure volume and weight. Finally, manure is a good product for agriculture. It contains N, P, K, nutrients, improves infiltration and aggregation, decreases the energy needed for tillage. Organic carbon and mineralizable N in manure-amended surface soils are 22 to 40% greater than in non-manure amended soils receiving fertilizer and/or herbicide. The conservation of N could reduce the cost of crop production, so manure has economic and energy efficiency potential. But the use of excess manure could have adverse effects: soil and water pollution, acidification, less water infiltration, which has an impact on soil-exchangeable K and P. The fast removal of the manure from feedlots can reduce the nitrate movement into the soil, maintain aerobic conditions and decrease odor [Eghball *et al.*, 1994]. According to these environmental or social benefits, emissions mitigation from manure is an important issue. This is why we will focus on this source.

iii. Comparison example of different methods to reduce manure GHGs

A study has been done by Kaku in Thailand in 2008 about the comparison between GHGs emissions with and without mitigation options for broiler manure in the context of a small-scale CDM, which can be used to have credit in the ASEAN and Japanese livestock industries. This study estimates GHGs emissions from three different waste management systems in the broiler industry in Thailand in an international market (mainly for the Japanese customers): incineration, drying without energy input (with sunlight), drying with energy input (thermal energy). The CH₄ emissions for one management of broiler excretion are obtained by multiplying the emission factor for a treatment with the amount of organic matter in broiler manure. CH₄ and N₂O emission factors for sunlight drying are 0.20%, CH₄ and N₂O emission factors for thermal drying are 0% and 2%, CH₄ and N₂O emission factors for incineration are 0.40% and 0.1% respectively. From 1994 to 2003, the GHGs emissions increased of 26% because broiler and pork were the favorite meat in Thailand and decreased of 37% in 2004 (baselines) because of the influenza (less production). If we use energy, GHGs emissions will be reduced by 57% and incineration will increase GHGs emissions by 17% if we compare to the no mitigation option scenario (see Appendix IV) [Kaku *et al.*, 2008].

Hishinuma in 2008 compares different methods of mitigation (composting and biogas plants) in Japan, where GHGs emissions from manure treatment and application represented 26.3% of the agricultural GHGs emissions. Three cases are observed for 100 cows: composting at a compost depot and then application (case 1), solid and liquid composting and then application (case 2), biogas plant for slurry treatment and then application (case 3). Efficiency of NH₃ reduction and fuel consumption for splash plate (spreading slurry to the air), band spread (spilling to surface through hoses) and shallow injection (SI) into the soil have been compared, and CO₂, CH₄, N₂O, NO, SO, NH₃ are also taken into consideration for each process. No emissions related to the energy in the case 3 are observed because a co-generator is used instead of electricity or fuel. The lowest NH₃ emissions are for case 3 but it requests fuel for the manure application. GHGs emissions are the highest in case 2 and the lowest for case 3 (because of lower emissions during manure treatment and higher N₂O emissions from composting). Thus biogas plant is the best option. Acidification gases emissions from manure treatment were divided by 2 for case 3 compared with other cases. However, NH₃ emissions from digested slurry application were relatively high. Biogas plant with digested slurry application and with SI seems to be the best option according to this study. [Hishinuma *et al.*, 2008]

b. Choice of the studied technologies to reduce manure GHGs

According to what we said before, manure appears to be an important GHGs source and many mitigation options exist to reduce the amount of the gases emitted. The benefits from manure mitigation options are numerous (environmental or economic).

Especially, it appears that among all the mitigation options that exist in the literature, anaerobic digesters, especially the largest ones, seem to be one of the best technologies to reduce GHGs emissions from manure: in 2005, 39% of the agricultural non-CO₂ emissions came from livestock, whose 7% from manure (the digester could help to decrease this percentage) [IPCC, 2007], many studies about this, a lot of environmental, agricultural and social benefits, high effectiveness to reduce GHGs, no important adverse effects, can be cost-effective (see below)... Thus this study will focus on the comparison and cost-effectiveness analysis of several anaerobic digesters to reduce the GHGs emissions, especially CH₄ emissions, from manure.

c. Anaerobic digestion

i. Background

Anaerobic digesters are used to treat biodegradable organic matter, such as manure, by the use of bacteria which will create CH₄ biogas. The aim of this option is to recover the CH₄ before its emission in the air, and use it for electricity, offsetting purchases electricity, heat, offsetting purchases of propane or natural gas, or hot water production, to reduce household and farm operating costs [USEPA, 1999].

Anaerobic digestion takes place in six steps (see Appendix V):

- Hydrolysis of solid organic particles or high molecular weight compounds (which are too large to permeate the cell membrane). It is catalyzed by extracellular enzymes released by fermentative and/or acid forming bacteria.
- The carbohydrate and protein hydrolysis will create sugars, lipids and amino acids, and they will become volatile fatty acids (VFA), H₂ and CO₂ by fermentative bacteria.
- H₂ producing acetogens oxidize VFA and long chain fatty acids into acetic acid, H₂ and CO₂. These bacteria work with methanogens which consume the H₂ produced during oxidation.
- CO₂ and H₂ will be transformed into acetic acid by homoacetogenic bacteria.
- Acetic acid will be degraded into CH₄ and CO₂ by acetoclastic methanogens.
- H₂ utilizing methanogens will reduce CO₂ to CH₄.

This process can be done at psychrophilic (10-25°C, but at a low biogas production), mesophilic (more common, 30-40°C) and thermophilic (50-60°C, the biogas production is faster but more difficult to manage) temperature with a batch reactor (5 operations: fill, react, settle, draw, idle), a sequencing batch reactor (for farm scale operations), and continuous flow reactors (plug flow reactor). [Massé *et al.*, 2011]

An anaerobic digester can be fed with manure, water, plant matter, straw and other materials. Manure can bring fresh bacteria and stabilize the pH (usually at 7.5-8) and so the environment. The OM in liquid manure is lower than in solid manure. The plant matter such as crop, fruit or vegetable waste have a high CH₄ production potential and can easily be assimilated by bacteria. A balanced food ration (which depends on the fat and protein quantity, the C/N ratio or the NH₃ concentration for example) is essential for the well-running of the digester (otherwise, the biogas production will be lower and the digester could be damaged). [ADEME, 2011]

Such a system has 4 components: a manure collection system, the anaerobic digester (to stabilize manure and optimize the CH₄ production), a biogas collection system (collected and piped to a combustion device) and a gas use device (heat or electricity). [AgSTAR, no date] (see Appendix VI)

There are 8 different kinds of biogas recovery systems (table 3):

Biogas recovery system (= anaerobic digester)	Description
Large-scale covered anaerobic lagoon (13% of the biogas recovery system in the USA)	A flexible cover is installed over the lagoon, the CH ₄ is recovered and piped to the combustion device. This method is the cheapest one but inappropriate at low temperature. It requires low manure solid concentration (< 3%) for swine/dairy and the CH ₄ can be used on-farm. This technology is not heated so the gas flow can vary a lot.
Plug flow digester (51% of the biogas recovery system in the USA)	Tank with a rigid or flexible cover and a heated underground (same temperature and gas flow, used in cold climate), and limited to dairy manure because it requires 11-13% of solids content.
Complete mix digester (26% of the biogas recovery system in the USA)	Enclosed heated tank with a mechanical, hydraulic, or gas mixing system. This method is better with diluted manure and requires 3-10% of solid content. The wastewater spends 15-20 days in the tanks. Used in all climates, especially in warm one, the manure being flushed out of barns with water.
Fixed-film digester	Adapted to low solid content (3%, manure diluted with water) in warm climate. The tank stays in inert environment and the bacteria grow as a biofilm.
Dome digester	Small-scale and unheated. A cylinder in the ground is divided in two by a wall, which is used in developing countries like China and India. The biogas is used for cooking and other energy needs.
Polyethylene bag digester	Small-scale and unheated, used in developing countries and the biogas is destined for cooking or other energy needs. This option is a simple hole in the ground covered with a plastic bag with an area for manure and pipes for the biogas produced.
Covered lagoon (small-scale)	Cheaper than a large-scale one, the biogas is also used for power, cooking, and other farm use.
Flexible-bag digester	Cheap and used in developing countries, the biogas is collected with a plastic bag.

Table 3: The biogas recovery systems (or anaerobic digesters). Source: USEPA a 2006 and AgSTAR no date

The four first options are applied only in the USA, EU-15, Japan, Australia and some other developed countries and also in Eastern Europe, Central and East Asia, China, and South Korea according to the climate, the environmental regulations or the costs. They are estimated to reduce CH₄ emissions by 85% (maximum) compared to the baseline (when CH₄ is released into the atmosphere) as mentioned part I.B.a. [USEPA a, 2006]. Other studies find differences according to the animals: 62 and 70% less CH₄ from dairy and hogs [Chadwick *et al.*, 2011], or according to the climate: 50% less GHGs from the farm-scale, centralized digesters in cool climate, 75% less GHGs in warm climate in Europe [Bates, 2001]. The four other options are applied in the other part of the world, in China and in some countries in East Asia, namely especially developing countries. They could reduce emissions by 50% (between 23 and 53% according to Hristov *et al.* (2012)). If an option has engines and equipment for electricity production, it will need twice as much labor than options which only produce heat. The animal production yields do not change with these options but other revenues could come from the use of CH₄ for heat and electricity. [USEPA a, 2006]

ii. Efficiency of this mitigation option

- Environmental, agronomic and socio-economic benefits (figure 2)

environmental	agronomic	socio-economic
<ul style="list-style-type: none">• Production of renewable energy, substitute of fossil fuel and C neutral (photosynthesized CO₂ of organic wastes will become CO₂ and CH₄ that will be used for electricity and heat, so they will return in the atmosphere)• GHG mitigation from manure storage, use of CH₄ for electricity and heat, fight against climate change and biodiversity losses• Impact of anaerobic digester on N₂O and NH₃ emissions from land-applied manure (23% less N₂O than with raw manure) and on water quality (70% less organic pollutants in manure, pathogens destroyed at 50-60°C or at 20°C during a few weeks)• Less waste transport [ADEME 2011]	<ul style="list-style-type: none">• Conservation of crop nutrient, decrease the use of fertilizer [Paustian 2004]• Increase the mineralized fraction of N and P• Reduce swine manure total and volatile solid concentrations by 80%, better manure homogeneity, lower viscosity, and uniform application• Preservation of the agro-ecosystems [IPCCb 2007]• Veterinary safety	<ul style="list-style-type: none">• Reduces odor and recycles nutrients back to farmland [Massé 2011]• Small impact on the landscape• Not very noisy• Possible creation of a recycling subsidiary to promote the organic waste• Green energy could be provided to companies• More activities can be done about the building and the running of anaerobic digesters• More energy independancy if enough biogas is created• Energy and money savings• Contribute to the national target of GHG mitigation

Figure 2: Benefits of the anaerobic digestion. Sources: Massé *et al.* 2011 for environmental and agronomic benefit, ADEME 2011 for socio-economic benefits.

Anaerobic digestion can lead to many benefits (figure 2). The GHGs mitigation from manure storage can be realized provided that a bioreactor eliminates fugitive CH₄ from the full bioreactor, the retention time is enough to extract most of the energy from the organic substrates and, the long term storage tank receiving the bioreactor effluent has a gas tight cover to collect and recycle residual CH₄. Moreover, the anaerobic digestion could be a potential solution for mortality disposal (reduces the risk of farm contamination related to transport of infected livestock carcasses but this is not allowed in the USA, and Europe made strict rules following the BSE case). [Massé *et al.*, 2011]

- AgSTAR guide

AgSTAR (see Appendix VII) developed a guide to find the place in the USA where the best opportunities are present to install and operate biogas recovery systems with dairy and swine manure. The profitable systems depends on the ability to recover the capital and costs at a good rate of return and generate a long-term income stream, which depends on the size of the operation (costs of construction and operation decrease when biogas system size increases and better financial returns can be made for a herd size over 500 cows or over 2000 heads in theory), the manure management method (liquid, slurry, semi-solid state, collection frequency), local energy costs (electricity price from the local electric utility), the carbon price, the baseline CH₄ emissions and reductions from the farms. This study concludes that for swine, 85% of the electricity generating potential is concentrated in 10 states, with North Carolina and Iowa (big pork producing states) each accounting for 20% of

the total. For dairy, 80% of the electricity generating potential can be found in 10 states, with California accounting for 40%. [AgSTAR, no date]

C. Costs of anaerobic digesters and technical and economic feasibility assessment

a. Costs and cost-effectiveness

The cost-effectiveness of abatement technologies (anaerobic digesters or other options listed in I.B.a) depends on the cost of the technology, revenue impacts, GHG emission reductions, and GHG regulations, including the potential for emissions trading and/or any penalties imposed for non-compliance. Thus, the cost-effectiveness of these technologies will vary from country to country [De Klein *et al.*, 2008]. This cost varies with the size and the type of the system, the type of livestock operation, and the site-specific conditions. An analysis has been conducted by AgSTAR from 28 dairy farms, of which 10 have complete mix digesters, 16 have plug flow digesters, 2 have covered lagoons, based on the prices of 2005-2008. The variability in the costs in this analysis is based on the different equipments used. So only the costs of system components that are included in the available cost estimates are taken into account. Total capital cost for plug flow is higher than the complete mix one. Other components are also included in the price “equation” like hydrogen sulfide treatment or utility charges [AgSTAR, 2009].

o Differences among the digester type

A study by USEPA (1999) analyses the costs of emission reductions. The most feasible and cost-effective option for the reduction of the manure CH₄ emission is the CH₄ recovery. Its cost depends on the recovery type, the option chosen and the farm size. The cost of the covered lagoon for dairies is \$150 000, for a break-even herd size of 500 heads which provides \$29 000 annual revenue. The break-even herd size and the annual revenue are smaller for a covered lagoon in dairy farms than with a complete mix and the costs are lower too. The same observation can be made for hogs. Indeed, the cost for a covered anaerobic digester in 1997 (includes lagoon, cover, gas piping) was \$245 - \$380 per milk cow and \$130 - \$220 per hog. Whereas, the cost for a complete mix digester (includes vessel, heat, mixing system, gas piping) was \$235 - \$410 per milk cow and \$130 - \$260 per hog. The engine generator cost \$160 - \$260 per cow and \$32 - \$90 per hog. It cost also \$750/kW. [USEPA, 1999]

Finally another study has been done in Kenya by Ochieng (2010) to test the performance of Plastic Tube Digester (PTD) installed by a company called Pioneer Technology, and to collect data to continue or not the implementation of PTD in Rwanda. Five counties were selected for the visiting farms (the others are similar to these ones). 87% of the digesters are in rural areas. According to Pioneer, the cost is \$525 and \$810 for a standard PTD (6m³, 1 dairy cow, 2.4m³ of gas produced/day, 65% of the digesters installed) and for a large PTD (16m³, 1-3 dairy cows, 3.2m³ of gas produced/day) respectively, whereas the study on the field found a cost between \$250 and \$562.5 (some of them have not been installed by Pioneer but by other companies whose some of them joined Pioneer in 2006, and the material price for PTD increased so Pioneer’s competitor found prices cheaper). It appears that a 6m³ fixed dome in Rwanda costs \$473, a plastic tube digester in Rwanda costs \$548, \$351.38, \$461.29 (estimations, locally made with no subsidy, locally made with subsidy,

imported from Kenya with subsidy respectively), a plastic tube in Kenya costs \$548. Thus a locally produced PTD with subsidy is less expensive than a dome digester of equal size, but the PTD production costs in Rwanda are the same than the one in Kenya. This study found that 82.4% of the digesters produce gas regularly, and 5.9% of them had holes, easily repairable, in the bag due to animals or children, 8.8% do not work because they burst or thick scum appeared due to bad feeding. For those receiving gas from the digester, 100% have the cooking stove working and produce enough heat, but in the evening, cooking and heat can be limited because of the low gas production at these times, and on the contrary, during mid-day on sunny days, the production is high. So gas storage could be the solution but none of the farms have one. Thus, this study found that these digesters are working quite well. The biogas produced is used for cooking but not for lighting (too low gas pressure) and leads to less use of charcoal and firewood and less indoor air pollution. The slurry is used as a fertilizer and soil conditioner. Moreover, the payback period (investment costs/savings) can be found being based on firewood use (43 months for fixed dome digester, 29 for PTD), on biomass residue (66 months for fixed dome, 43 for PTD) or on charcoal. A family of 5 persons will use 64.7kg of charcoal/month. The payback period found is 17 months. As the price should increase, this period is shorter and PTD is attractive. Health expenditure decreases, 10% of the farmers think they improved their way of life thanks to the convenience and cleanliness of the gas, and benefits were obtained from the use of slurry as a fertilizer or soil conditioner. Moreover, infrequent feeding, over-feeding and under-feeding lead to low pressure and/or low gas production. With good maintenance, and education including good extension services (like visits, support...), these PTD's can last up to 15 years. Finally, this study showed that 5.9% of the farmers stopped their plastic tube and built a masonry digester because of the increase in the need of energy (lighting and cooking) and because of the low gas pressure in the morning and late evening (long cooking time). It looks like the PTD is recommendable in Rwanda but farmers will need support and training, skills to repair the digester, materials and the owner have to be involved in the funding of the digester. [Ochieng, 2010]

○ Differences among the country conditions, scale and C prices

The efficiency of this mitigation option depends also on the country (climate, economics, projects, acceptability...). Liang *et al.* (2008) did a study in Malaysia to evaluate the viability of converting biogas from wastewater treatment system in pig farms into electricity. This paper explains the opportunities and challenges during this study and then shares the experience with farmers and carbon credit trading companies to prepare for an eventual future project. However, to achieve the carbon emission reduction fixed by the CDM project, between 100 000 and 130 000 pigs are needed. Pig farm size is between 100 and 20 000 pigs in this country. So the chance to develop a CDM project is low. This study concludes that in Malaysia, anaerobic wastewater treatment is a good source of renewable energy, can decrease the GHGs emissions by 9.4% (compared to the total baseline emissions found for this project), can enhance the quality of livestock wastewater, and have a quite short payback period (6 years). But this technology seems to be applicable or successfully practiced only in large scale industries (like in developed countries). For smaller livestock farms in developing countries, there will be some problems that prevent the use of this technology: reduction of water usage, sometimes no real support by the government for such projects (even if they have signed the Kyoto Protocol), not the same electricity demand at each time of the day, which leads to a

lack of electricity produced by the digester at a moment of the day (early morning-midday), and an excess the rest of the day, a lack of mechanisms for selling the electricity. [Liang *et al.*, 2008]

Baylis *et al.* (2011) explained that in Canada, only farms with more than 675 dairy cows are recommended to use an anaerobic digester (using three price scenarios, and given electricity (\$0.10/kWh) and C (\$15/tCO₂eq) prices). However, this statement can be discussed because no difference has been made between fixed investment and cow investment costs. This herd size depends also on the model used. Hog farms would have to produce almost 2000 hogs/year to economically justify purchasing such a technology. Thus, for an average Canadian hog operation (1700 head), C prices will need to be a few dollars higher than the baseline taken in this study (\$17/tCO₂eq) to justify the use of a digester (the C prices depend on the cost of the operation). C prices are very important to enable the use of a digester (\$13/t in the USA [Key *et al.*, 2011]). Moreover, all hog operations in Canada use liquid manure storage, so digester systems are widely applicable as a CH₄ mitigation option. The model is also sensitive to electricity prices. In Ontario, when the electricity price changes from 0.10 to 0.14 \$/kWh and anaerobic digester becomes feasible for 200 dairy cows operation and for less than 500 hogs operation. Sometimes, the digester would not be adopted for electricity production without renewable energy subsidies or higher electricity prices [Baylis *et al.*, 2011]. This is why only a few digesters exist in France, the electricity price (46-78€/MWh) is not enough, despite increases in these prices to 110-140€/MWh in 2006 (became higher than in the US at this time, where the price was 8.9ct/kWh [USEIA, 2007]) [Levasseur *et al.*, 2007]. In Germany, a higher price (150-210€/MWh) allowed a lot of digesters to be built. [Levasseur, 2006]

The anaerobic digestion cost-effectiveness criteria are: the promotion of the heat produced (subsidy, use the heat for the house, the animals building...), the optimization of the biogas produced, and economies of scale. The investment unit cost decreases with the increase of the electric power of the operation. The farm size and especially the amount of by-products introduced in the digester can increase the biogas production. In France, 53%, 44% and 3% of the pig farms, which represent 15%, 69% and 3% of the sow population, have less than 100, between 100 and 500, and more than 500 sows respectively (data taken from a study done by SCEES (Service Central des Enquêtes et Etudes Statistiques) in 2005). Three cases of anaerobic digestion at 38°C have been compared: only swine liquid manure (case 1), manure and corn silage (case 2), manure and waste of vegetables and fat (case 3). Each case contains as much manure as by-products. The indemnification and the transport costs are not taken into account. The whole investment is funded by loans. The investment return time (IRT) has been calculated for the three scenarios (see Appendix VIII). For the case 1, the energy produced by the co-generator is not enough to heat the digester at 38°C in Brittany (need 88 MWh/year for a 100 sow's farm whereas only 80 MWh/year is produced). Thus this project is not feasible technically and economically. The amount of dry matter (4%) is not enough to allow the anaerobic digestion. The case 2 does not seem cost-efficient because of too high investment and corn silage market prices (18€/t should be enough to have a 10 years IRT, which is far below the currently prices) and probably also because the electricity prices are too low. The energy promotion is not enough. However in Germany, this kind of process (liquid manure and corn silage) exists with a subsidy of 0.06€/kWh for energetic culture use. Finally the case 3 seems the better one. Indeed, enough use of organic wastes (free and/or with a high anaerobic digestion power) could lead to lower IRT even for small farms. The promotion of the heat produced has little impact on the cost-efficiency

of the scenarios that already have a low IRT. Between 0.4 and 3.9% of the primary energy can be promoted (that could be higher if the temperature change and if the NH_3 and CO_2 concentration are lower). In French pig farms, the use of organic wastes with a high anaerobic digestion power is a necessary and sufficient condition to obtain a cost effective anaerobic digestion project. However, the use of an energetic crop is not cost-effective and the promotion of the thermal energy is not enough to improve the cost-effectiveness of the projects. [Levasseur *et al.*, 2007]

b. Technical and economic feasibility assessment

A guide has been prepared by AgSTAR in 2004 [USEPA, 2004] for the selection of an appropriate and cost effective biogas technology option. First of all, we must match a digester to the facility, which depends on the climate and the solids content of the manure. Complete mix and plug flow digesters can be used in all climate and need supplemental heat (waste heat can be captured from a generator) between 35 to 55°C. Lagoons do not use supplementary heat (because not enough waste heat) and need large capacities, so this option is feasible only in moderate or warm climates. In cold climate, lagoon can also decrease odor and GHGs emissions, and they should be equipped with flare systems to combust the biogas. The “as excreted” total solid content (TSC) is between 9 and 25% according to the feed and the animal type (25% for caged layers, 9.2-10% for swine). The solid concentration increases if we add bedding and decreases if we add water. Secondly, we need information about the climate, farm type (size, manure collection and treatment method), livestock population, manure management, energy information (rates, electricity and propane costs). And then, we can estimate the costs and revenues of the project. And finally, three techniques can be used to assess the economic feasibility of a project (figure 3):

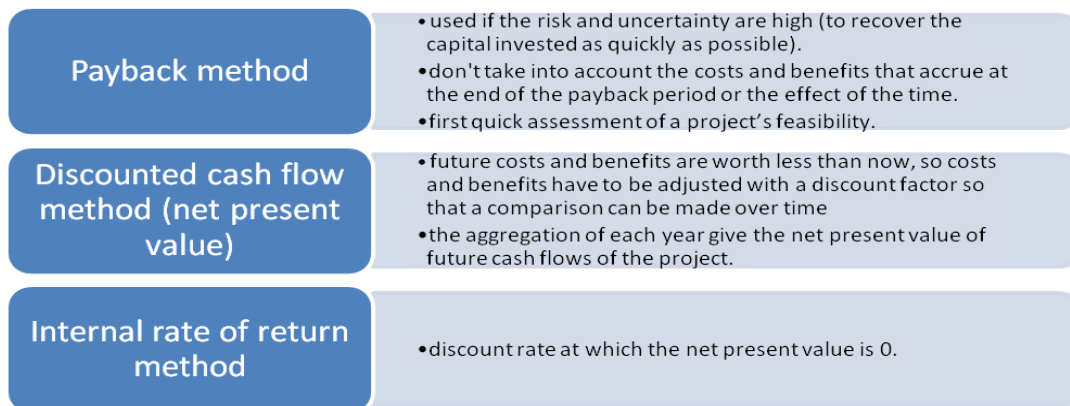

Figure 3: Methods to assess the economic feasibility of a project [USEPA, 2004]

D. MAC curves' usefulness: information given by these curves

Many organizations, consulting companies or researchers produce MAC curves (USEPA, McKinsey & Company, ICF international...). For example, the USEPA (2006) global analysis on the abatement potential of non- CO_2 GHGs looks at all non- CO_2 GHGs (CH_4 and N_2O that come from energy, agriculture and industry, and other GHGs that come from industry), the four emitting sectors of the economy (energy, agriculture, industry, waste) and all regions in the world. Previous studies made by USEPA (in 2006, 2001 and 1999) and the European Commission (in 2001) have been done to estimate the potential CH_4 and N_2O emissions reductions from all sectors and quantified costs and

benefits of these reductions. The points in the MAC determine the abatement potential for mitigation technologies at a given break-even price. Energy and agricultural sectors have the greatest potential for mitigation of non-CO₂ GHGs, whereas waste sector has the lowest potential. Of all the gases, the largest potential for mitigation is found for CH₄. Hence the importance to find mitigation options for this gas. At \$0/tCO₂eq, CH₄ mitigation is 500 MMtCO₂eq whereas N₂O mitigation is about 100-150 MMtCO₂eq. The N₂O curve is quite inelastic whereas the CH₄ mitigation curve is quite elastic (a small increase of the price will lead to a high increase of the CH₄ mitigation). China, USA, EU, India, Brazil emit the most non-CO₂ GHGs, so they can offer the biggest mitigation opportunities. Significant emissions reduction can be done at 0 or low C prices (see Appendix IX for MAC curves).

This report found that enteric fermentation is the second largest source of global agricultural non-CO₂ emissions (32% in 2000, 27% in the USA, 2% of all GHGs emissions). Global enteric CH₄ emissions represented 1799 MMtCO₂eq in 2000 and are supposed to increase more than 30% up to 2020. The livestock manure is the fourth largest source of global agricultural non-CO₂ emissions (less than 8% in 2000, 13% in the USA, 1% of all GHGs). Manure CH₄ and N₂O emissions represented 421 and 24 MMtCO₂eq in 2000. CH₄ and N₂O will increase by 24% up to 2020. At 0\$, the report found that the global mitigation for livestock management in 2020 is 3% (if the number of animals is constant) and 5% (if the production is constant). At 60\$/tCO₂eq, this mitigation is 7% (constant number of animals) and 10% (constant production) [USEPA a, 2006]. The USA have the greatest potential to reduce GHGs emissions if the number of animal is constant. If the production is constant, the MACs are quite different. The mitigation is larger at any price with this assumption. If options increase yields, a constant production can be obtained by decreasing the number of animals by the amount of the increase in productivity. Some mitigation options increase net GHGs emissions per animal but increase productivity much more, so we can have lower emissions per unit of output. But if a constant number of animals is assumed, then these options will lead to an increase in emissions. [USEPA a, 2006]

II. Methodology and results

The aim of this study is to build a model to calculate the break-even price of anaerobic digester technologies, and finally build a set of MAC curves for these technologies applied to dairy and hog producers in the USA and Vietnam, to know the cost-effectiveness of these options. We will use a “static” model. The costs and revenues are represented annually and the baseline emissions and prices do not change relative to 2010.

A. Model constructed for this study

First of all, we need to define the baselines for each sector. The abatement potential (horizontal axis of the MAC curves) then needs to be calculated for each option, and then the break-even price (vertical axis) can be found. The MAC curves can then be built.

a. The baselines

The USEPA (2006) model used the emissions projections from the USEPA's *Global Anthropogenic Non-CO₂ GHG emissions 1990-2020* [USEPA b, 2006].

In this study we use the baseline developed by USEPA (2011). In this database, historical estimates are reported from 1990 to 2005, every 5 years, and then, projections are done from 2010 to 2030 with a linear extrapolation. This USEPA (2011) report collected baselines from nationally-prepared GHGs reports, which give information consistent with the *Revised 1996 Intergovernmental Panel on Climate Change Guidelines for National Greenhouse Gas Inventories* (IPCC Guidelines), the *IPCC Good Practice Guidance and Uncertainty Management in National Greenhouse Gas Inventories 2000*, and the *Revised 2006 Intergovernmental Panel on Climate Change Guidelines for National Greenhouse Gas Inventories*. If information were missing for a country then IPCC default methodologies found in these previous IPCC documents, international statistics, and the IPCC Tier 1 default emission factors were used (growing emission rate) [USEPA, 2011]. These new baselines appear to be higher than the previous version published by USEPA in 2006. Thus, the potential to reduce the GHGs emissions is also higher and the corresponding break-even price could be lower.

b. Evaluation of the mitigation options

The previous step provided the GHGs emissions (total or per gas) for each country. Now, the use of some technologies is considered. Whereas the USEPA (2006) study used especially three other reports (USEPA (2001), USEPA (1999), European Commission (2001)) to evaluate the technologies and the CH₄ mitigation options costs, this study will just focus on the anaerobic digesters for the USA and Vietnam cases, according to information that have been found in the literature or thanks to personal communications. The sources for each one of the parameters for the abatement potential (baseline, technical applicability, efficiency to reduce the GHGs and implied adoption rate) and the break-even price (costs, revenues and yield) calculation will be presented later.

o The abatement potential

The abatement potential of an option can be found with the formula presented in figure 4:

$$\text{TAP} = \text{TA} * \text{IAR} * \text{RE}$$

Figure 4: Abatement potential calculation

With TAP = Total Abatement Potential (%), TA = Technical applicability of an option (%), IAR = Implied Adoption Rate (%), RE = Reduction efficiency (%).

The technical applicability is the percentage of baseline emissions from a single emission source to which a given option could be applied. For example, if an option applies only to the swine farms, then the technical applicability for this option is the percentage of emissions from swine relative to total emissions from livestock (swine and dairy in the anaerobic digester case). However, all swine options may not be applied to all swine emissions, thus the definition used in this study could be modified. In this study, the implied adoption rate is defined as the observed share of the digesters in the country in the 2010 baseline. Thus, it depends on the economic costs and benefits of each measure (some have a higher investment cost, others allow more electricity savings), the suitability to the climate in a particular location (a warm climate is requested for the non-heated digesters), non-

financial objectives of adopting the technology (e.g. solving odor problems), the livestock situation in a country or region (some counties/countries raise more animals or one type of animals than others and intend to animal production) and other parameters (See part II.D.a.). All these parameters will have an impact on the farmer choice for a digester type. In USEPA (2006) a different but equally strong assumption about the implied adoption rate was made: if there are n options, then each option is applied in equal 1/n shares of total emissions from each source, which may be unrealistic. This study will test alternative assumptions about this rate. The reduction efficiency is the percentage reduction achieved with the adoption of the option, taking into account the leakage⁴. The regional abatement potential of an option can be calculated using the formula in figure 5:

$$ER = TAP * B$$

Figure 5: Regional emission reduction potential

With ER = amount of emissions reduced by an option, which is the regional abatement potential (MMtCO₂eq), B = baseline (MMtCO₂eq) for each sector and region.

o The break-even price

The break-even price P is the carbon equivalent emission price that perfectly offsets the cost of the digester, i.e. the price that equalizes the net present value of the benefits and the net present value of the costs. The break-even price represents the cost-effectiveness of the technology and this price is initially used to rank the technologies one by one, without any consideration about their allocation in a country/sector. Thus, while figure 5 will be used to estimate the total emission reduction, or the horizontal axis of the MAC curves (MMtCO₂eq), this equation, without the implied adoption rate, will only be used to calculate the break-price P (expressed per Mt output) (figure 6).

$$\sum_{t=1}^T \frac{(1 - TR) * (P * ER + R) + TB}{(1 + DR)^t} = CC + \sum_{t=1}^T \frac{(1 - TR) * RC}{(1 + DR)^t}$$

Figure 6: Profit equation

With P = Break-even price (\$/MtCO₂eq), ER = emission reduction potential of the technology (Mt CO₂eq), CC = capital cost (investment cost in \$), RC = recurring cost (O&M) of the option (especially the labor costs in \$/year), R = revenue from energy production, sales of by-products (like compost), livestock revenue... (\$/year), TB = Tax break = CC*TR /T, T = lifetime of the digester, TR = tax rate (40%, [USEPA a, 2006]), DR = discount rate (10%).

The revenue could be: the value of the recovered gas (CH₄ used as a gas or for electricity, so the energy savings), the value of the mitigation of a gas like CH₄ according to a gas price (\$/tCO₂eq) and other benefits of the abatement (other than the decrease of the GHGs, like the increase of the yields or commercially valuable by-products such as the compost for example). The costs could include: the one-time capital costs (investment, equipment which could be considered as capital costs), the annual

⁴ Corresponds to the difference between the biogas production potential of a digester and the amount of gas actually used. This loss of gas occurs because of physical and design leakage in the biogas system for example.

operation and maintenance costs and the labor. The transaction costs are not taken into account in this study. In the present study, the MACs are constructed for 2 countries and real 2010 prices are used (i.e. prices from different time periods are corrected by the inflation rate, see part II.C.b.). Here we compare the benefits and costs in the baseline situation, where there are no digesters adopted, and the situation where there is adoption. For the benefits, the introduction of the technology will lead to an increase in the energy revenue (when there is an electricity production) but there is no change in the livestock production revenue and we suppose the digestate is not sold (indeed, the farmer often spread their own manure on their field, but selling their digested manure does not appear to be a common practice) and that the fertilizer savings associated with the use of the digested manure as a fertilizer does not change between the two situations (that means that we suppose the N and P content of manure before and after digestion does not change which is a strong but necessary assumption, given the lack of information found on this topic). Thus, R only includes the electricity savings. These latter have been calculated using a formula, which is actually quite close to the one found the study done by Minchoff in 2006. In addition we used more parameters to show the difference in the efficiency of the heated digester (plug flow or complete mix) and the unheated one (lagoon) to capture the methane. The formula to calculate the electricity produced is this one (figure 7):

$$\begin{aligned}
 EP &= BP * 600 * ColLE * ConvE \\
 ElecP &= EP * \frac{1}{3412} \\
 R &= price * ElecP
 \end{aligned}$$

Figure 7: Electricity revenue-savings calculation

With EP = electric Energy Produced (Btu/d), BP = Biogas Production (ft³/d), 600 = energy content of the gas (Btu/ft³), ColLE = Collection Efficiency of the digester to collect the methane (%), ConvE = Conversion efficiency of the digester to convert the energy into electricity (%), ElecP = Electricity Produced (kWh/d), R = Revenue electricity (\$/d), price = electricity price (\$/kWh).

We suppose that 60% of the biogas is CH₄ and the heat potential of the methane is 1000, the efficiency of the digester to collect the CH₄ is 99% for the heated digesters (plug flow, complete mix, fixed film) and 75% for the non heated one (lagoon), and the efficiency to convert the biogas into electricity is 25% [Lazarus *et al.*, 2011]. At this time we can have the electricity produced in Btu/day, so we convert it into kWh/year while multiplying by 1/3412 * 365. And then the revenue can be obtained while using the electricity price (which changes among the states⁵). Thus we have the total energy savings (electricity sold or savings if we assume the selling price of the electricity is the same than the buying price).

For the recurring costs, only the labor costs change compared with the baseline situation where there is no digester. So RC is the change in the labor costs (LC).

The sources of the costs, revenues and prices found for this study will be presented later.

In this study, we assess the net costs before tax (TR = 0). Thus the formula used for the break-even price calculation is presented in figure 8 (see Appendix X for explanations):

⁵ Source: <http://www.eia.gov/electricity/state/> visited on the 7/7/12

$$P = \frac{CC}{\frac{ER}{T} * S} + \frac{LC/T}{ER/T} - \frac{R/T}{ER/T}$$

Figure 8: Break-even price with annual parameters and before tax

With S = annuity factor = $\frac{1 - \left(\frac{1}{(1 + DR)^T}\right)}{DR}$ (see figure 9 for explanations)

The present value PV of a price Pr is:

$$PV = \sum_{t=1}^n \frac{Pr}{(1 + DR)^t}$$

$$\longleftrightarrow PV = \frac{Pr}{1 + DR} + \frac{Pr}{(1 + DR)^2} + \dots + \frac{Pr}{(1 + DR)^n}$$

$$\longleftrightarrow PV = \frac{Pr}{1 + DR} * \left(1 + \frac{1}{1 + DR} + \dots + \frac{1}{(1 + DR)^{n-1}}\right)$$

$$\longleftrightarrow PV = \frac{Pr}{1 + DR} * \frac{1 - \left(\frac{1}{(1 + DR)^n}\right)}{1 - \left(\frac{1}{1 + DR}\right)}$$

$$\longleftrightarrow PV = Pr * \underbrace{\left(\frac{1 - \left(\frac{1}{(1 + DR)^n}\right)}{DR}\right)}_S$$

Figure 9: Explanation of the annuity factor calculation

As mentioned, we use a static framework, thus we do not project changes in annual emissions, productivity, or prices for capital labor and outputs. Thus, while the technologies are assumed to have a 20 year lifespan, we focus on the 2010 base year, and the estimated present values reflect the situation in 2010. All parameters are expressed as annual amounts including the capital cost which is annualized by dividing by the annuity factor. The value of the discount rate has been fixed at 10% but a sensitivity analysis will be conducted for this parameter (see part II.D.b.).

Thus we can have the results without taking into account the tax (social perspective). If the tax rate is taken into account (40% [USEPA a, 2006]), the break-even price can be found with this formula (figure 10, see calculation Appendix X, every parameter is annualized):

$$P = \frac{CC}{ER * (1 - TR) * S} + \frac{LC}{ER} - \frac{R}{ER} - \frac{CC * TR}{T * (1 - TR) * ER}$$

Figure 10: Break-even price after tax

As each digester is independent from the others, the adoption of one option will not affect the effectiveness of other one. Thus we will not need to account for interactions between measures, which may be necessary when considering multiple mitigation options for enteric fermentation emissions.

○ Constant population/production

The MAC curves can be built in two different ways. We can choose to construct the curves assuming constant animal population (total production changes because of the change in the yield/ha and the productivity/animal) or assuming constant production (the population changes with the modification of the yield/ha to have the same final production). A lot of mitigation options could actually increase the emissions per head but also the productivity. Thus they decrease the emission per unit of output. In practice, we can have a reduction of the GHGs emissions with the increase of the productivity through these mitigation options while reducing the number of head in equilibrium to meet the global demand. Finally, we can observe a decrease in the GHGs per unit output (the aim of this study and of the mitigation options) even if there is an increase of the emissions per head. In this study we choose to be at constant production, so every value has to be expressed per metric ton of output.

c. Building the MAC curves

To build these curves we need to first calculate the break-even price, P , and the abatement potential, ER . The options are then classified in an ascending order of P and the incremental value of the abatement potential is calculated. Each point represents the price for an option and its associated GHG emission reduction. The MAC curves therefore represent the marginal costs of each unit of emissions reduced, based on the mean net costs of these reductions by each option. As mentioned, ER is typically reported on the horizontal axis and the unit costs on the vertical axis. The adoption rate depends on the number of available options and assumptions about the share of farms to which each option can be applied to. If the same distribution of the options used by the farms in baseline is assumed, then it means that the market share of each option will not explicitly consider their cost effectiveness, otherwise the most cost effective option would be applied uniformly everywhere, which may be an even less realistic assumption (see II.D.a.). Further social factors affecting the use of an option in a particular market are not taken into account. Because of their qualitative nature they are difficult to quantify. Given the way the implied adoption rate is calculated in this study, the observed distribution of the digesters in the baseline is of critical importance in assessing the total abatement potential for the anaerobic digesters in the US and Vietnam.

d. Assumptions

For this study, some assumptions were made. To calculate the abatement potential and the break-even price, we suppose that:

- We do not take into account environmental policies that can encourage some technologies, or the effect of some possible information or administrative implementation barriers
- We do not take into account the indirect emissions reductions e.g. the one that could come from the substitution of the electricity from the grid with the electricity produced on-farm
- We do not take into account the qualitative parameters such as the social factors
- The lifetime of the technologies is assumed to be 20 years, except for the Vietnamese polyethylene bag whose lifetime is 3 years
- We chose to do a static study: each parameters do not change during the 20 years horizon time, and the technologies themselves do not change

- Because of the lack of data in the dairy sector in Vietnam, we will study only the pig sector, and the list of the existing technologies and their share have been obtained thanks to expert judgment
- The implied adoption rate found in 2010 (see below) is assumed to stay the same over the 20 years time horizon (static study). The rate found for the USA for each kind of digester and for dairy and pig sector comes from the list of digesters made by AgSTAR and we assume this list is the biggest one for this technology in this country. The rate found for Vietnam (total share without any distinction between dairy and pigs) is assumed to be the same for pig sector.
- The technical applicability related to the 2011 baseline used in this study is assumed to be the same than the baseline used in the USEPA's 2006 model (no such information has been released for the 2011 report, so it was not possible to calculate it again)
- The reduction efficiency is 70% for hogs and 62% for dairy in the USA (AgSTAR source) and 60% for Vietnam (expert judgment)
- The P calculation does not take into account the transaction costs because of the lack of data
- The labor costs are the only variable costs that change with the adoption of the digester, and we suppose that the number of hours required for the digester used in the American model are the same in 2010 (very few information exist about this) so that we can borrow this information from this source. Due to a lack of information, the price will be assumed not to change also but it will be corrected for inflation between 2000 and 2010 (the price used in this study is from USEPA (2006) but expressed in 2010 US dollars)
- We chose to consider only the changes in the electricity savings for the revenue (efficiency of the digesters : 25%), and assume that the fertilizer savings do not change as explained before
- We assume constant production
- We take into account the digesters operational in 2010 to determine the distribution of digesters (implied adoption rate), no matter when they have been built. Then, all the digesters present in the country until the baseline 2010 are considered here (those that have been built after are not taken into account). That means that each digester has a given and maximum share of the adoption rate at any C price. Thus, we can study the 2010 situation and the potential of each kind of digester to abate the GHGs according to their real distribution in the country. The costs of the digesters in particular, expressed with the dollar value of the related study or of the year they have been built, will be converted in 2010 US dollar.

One of the aims of this study is to test some of the assumptions used by the USEPA (2006) (table 4 lists the assumptions that will be tested), which estimates the GHG abatement potential for many countries in the world and for many technologies or options (anaerobic digester, improved feed conversion, antibiotics, propionate precursors, intensive grazing for example). Given its global scope and wider range of mitigation options, a lot of assumptions were necessary which may not reflect the reality and which should therefore be evaluated.

USEPA (2006) tested assumptions

Data

- If we lack data about revenue for a region, the model is based on 2 ratio: average prices of natural gas or of electricity in this region/ average prices of natural gas or of electricity in the USA, GDP per capita in a given region/ GDP per capita in the United States
- The share of each technology is supposed to be 1/n if n technologies are available
- No distinction is made across the farms with regard to scale and localization and the impact of these factors on adoption

Model and calculation

- Can extrapolate the abatement potential and the costs from one representative farm to the entire country, without any consideration of the spatial and temporal differences within the biophysical and management conditions
- Discount rate fixed at 10%
- Tax rate fixed at 40%
- The large scale digesters are assumed to have a 20 years lifetime and 10 years for small scale

Table 4: List of the USEPA (2006) assumptions tested in this study

B. Geographical scope and technologies considered in the study

The digester technologies that can feasibly be applied in developed countries appear to be very different to those that are feasible in the developing countries. Thus, this study will be based on one example for each case.

a. Example among the developing countries

i. Choice of the country

In the 1980s, the annual per capita meat consumption in developing countries was about 14kg. The main purpose of livestock was not necessarily for food (products too expensive), but often for manure, power, or insurance in case of emergency. Then, population growth and increased incomes led to an increase in meat consumption (up to 28kg/capita/year in 2002 [FAO, 2006]), especially for monogastrics meat, like pigs, whose number of animals increased four-fold between 1980 and 2004 [FAO, 2006]. Pig manure managed in liquid is responsible for a huge part of the CH₄ emissions. Consequently, this growth led to environmental and disease problems (influenza for example). South-East Asia has especially become an important place for manure collection and livestock and the GDP per capita grew by 3.6% from 1991 to 2001 [FAO, 2006]. Finally, many CDM projects and anaerobic digesters have been built in this area to address some of the environmental and economic challenges of manure management in this region.

Vietnam is the 20th biggest CH₄ emitter in the world. The swine production creates 630 000 tCO₂eq per year [Eastern Research Group *et al.*, 2010]. There are 27 373 100 pigs and 5 916 300 cows in Vietnam in 2010⁶ (5th country in the world in terms of pig number, and 6th for the meat production [GFA b, 2011]) and most of the manure from these sectors is untreated. Vietnam is one of the countries in South-East Asia that has recently grown the fastest (6.5% in GDP between 1998 and

⁶ http://www.gso.gov.vn/default_en.aspx?tabid=469&idmid=3&ItemID=11740, visited on the 19/06/2012

2003, 8% from 2004 and 2007). 20% of the GDP comes from the agriculture, and 20% of this comes from livestock [Easter Research Group *et al.*, 2010]. Meat and milk production increased by 7.3 and 12.6% respectively from 1995 to 2007 and among the meat, pig meat production increased by 148% and cattle meat production doubled in the same period. The consumption per capita also increased from 1995 to 2005 (6.4% for meat and 11% for milk). To meet the demand, the country has also increased its importation of livestock (12.9% from 1995 and 2006) [FAO, 2009]. In 2000, there were only 2000 small scale digesters in the country. In 2007, their number was at least 10 times higher [Easter Research Group *et al.*, 2010]. Biogas technology has been studied and applied in Vietnam since 1960. Then, the technology has been widely applied at different scales, which represents many benefits to the society and the environment. Biogas plant provides fuel for cooking and lighting demand of small farmers. Thus, they have economic benefits and improve household conditions and quality of life. By using biogas, farmers reduce the use of firewood, its collection and/or purchase, the indoor air pollution caused by combustion of firewood and reliance on forest resources of the community. They can also use the biogas for electricity production, but this practice is for the moment not well developed in Vietnam. Finally, during the period 2001-2010, the government created many policies to encourage the development of a sustainable livestock sector [Nguyen Quang Dung, 2011]. Thus, MAC curves will be developed for this country, to assess and demonstrate the economic performance of some options that are relevant for developing countries.

ii. Studied technologies

The studied technologies for this country will be: the VACVINA digester, the domes KT1/2, the composite digester and the polyethylene (or plastic) bag. These digesters are not the only one in Vietnam. Indeed, other types also exist such as the TG-BP or the EQ model. However, the TG-BP is an old version of a digester (KT1/2 and EQ are improved versions) and the EQ model is not well spread (only about 200 units in Vietnam). The plastic digester bag (polyethylene bag) with separate gas storage bag (between 2 and 10m³) is dominating in some southern provinces (see a picture of this very simple technology Appendix XI). The number is very high but difficult to quantify because the material is easily available on local markets. The KT1 and KT2 (from 8 to 15 m³) are spherical shaped fixed dome digesters. They are the most popular rural biogas plant models after the plastic bag. The covered anaerobic lagoon is a simple technology in Vietnam. The sheet for covering the lagoon to store the biogas is made of HDPE. The bottom of the lagoon is sealed by compacted soil, covered by HDPE or made of concrete. [GFA a, 2011]. The VACVINA digester is an improved version of the dome and aboveground covered digester to overcome the disadvantage of these two technologies and keep the benefits. But this digester is still being tested in some provinces and it appears to be more efficient than the basic dome [Hai Anh, 2010]. A more detailed description of each one of these technologies can be found in Appendix XI. These digesters are made to fit the very small herd size that we can find in some developing countries: farm-scale and very basic. These digesters enable farmers to save money from heat generation (the heat produced by the digester is used on farm or for cooking), they can decrease the GHGs emissions, and if a CDM project is developed, the decrease of the emissions in Vietnam leads to carbon credits and developed countries can meet their targets with respect to the Kyoto protocol. A study done by Huu Luu *et al.* in 2011 about the comparison of 2 biogas digesters in 3 regions in Vietnam, explains that 97% of the biogas users have pigs and 3% of the digesters users have only dairy cows (44% have both pigs and cows).

Thus, and also because of the lack of information about the dairy sector in Vietnam, only the digesters in the pig farms will be taken into account and we will suppose that the share given before represents the share of each technology for the pig farms.

We can classify the costs into 3 categories: the capital costs (first investment for the digester, the engine-generator, the cost of the engineering design, the installation), the labor costs, and the other input costs (material and supply, services, running costs...). As explained before, only the capital costs and the labor costs change. These two costs do not have the same share of the total costs (figure 11) and so, will not have the same impact on the break-even price.

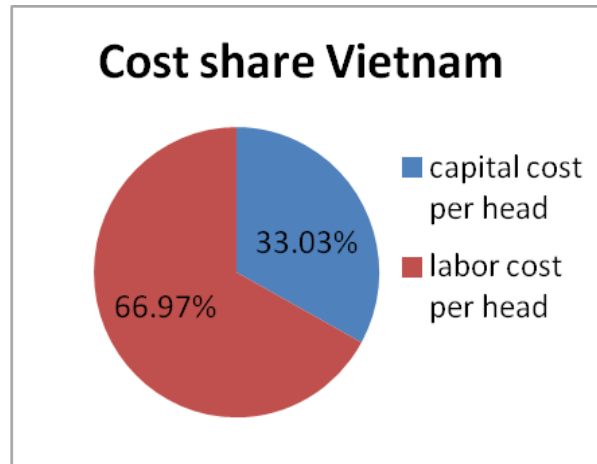

Figure 11: Cost share for the Vietnamese technologies

In Vietnam, the capital costs of the digesters are not very high, and farmers often have help from a project to build a digester. However, even if the labor price is really cheap in Vietnam, they need maintenance and repair (some of the digesters can last only 3 or 10 years) and the technicians often need training, so they need labor time. This observation also demonstrates the “induced innovation” theory (Ruttan and Hayami): the economic system, and so the relative factor scarcities, has an effect on the prices and the innovation. Thus, the share of the labor costs is more important in this country.

b. Example among the developed countries

i. Choice of the country

The situation in developed countries is quite different. Indeed, the consumption of livestock products has not increased much in recent decades, as the population growth has been low and markets have reached a relatively stable equilibrium for the supply and demand of livestock products. One reason consumption is not growing is that people are concerned about health issues from high intake in livestock food which could lead to diseases or cancers for example. Thus, livestock production only increased by 22% only between 1980 and 2004 (ruminant production decreased and monogastric production increased, especially poultry which is acceptable to all religion groups) [FAO, 2006]. Even if the production did not increase a lot over the past years, the GHGs emissions from the developed countries agriculture are still very important. The increase in the population in these countries will also have an impact on livestock production and GHGs emissions. Thus, and for many other reasons, manure management in these countries could and should be improved.

In the USA, meat and milk production increased by 1.8% and 1.5% respectively from 1995 to 2007. For meat, pig and cattle production increased by 22.9% and 4% respectively. Thus compared

with the production growth in a developing country such as Vietnam, we can see that the evolution of the livestock production in the USA is low. The consumption per capita of meat barely increased from 1995 to 2005 (0.8%) and even decreased for milk (0.1%) [FAO, 2009]. Finally, the USA was the second biggest polluter in the world in terms of CO₂ in 2008 and the 4th one in 2005 in terms of agricultural CH₄ (France is 18th)⁷, and has the highest emissions from manure in the world, many anaerobic digesters have also been built in this country, and they have a special program about digesters (AgSTAR). Thus, we can discuss the efficiency of some options especially used in the developed countries, through the example of the USA.

ii. Studied technologies

The studied technologies for this country will be: for the dairy sector, the plug flow, complete mix and covered lagoon digester with and without an engine for electricity production, and the fixed film digester without engine; for the pig sector, the covered lagoon with and without engine, the plug flow and complete mix digester with engine. A small description has been made part I.B.c.i (see Appendix XII for more details). Some other technologies can be found in the USA but not enough data were available about them.

As for Vietnam, only the capital costs and the labor costs change. These two costs do not have the same share of the total cost (see figure 12):

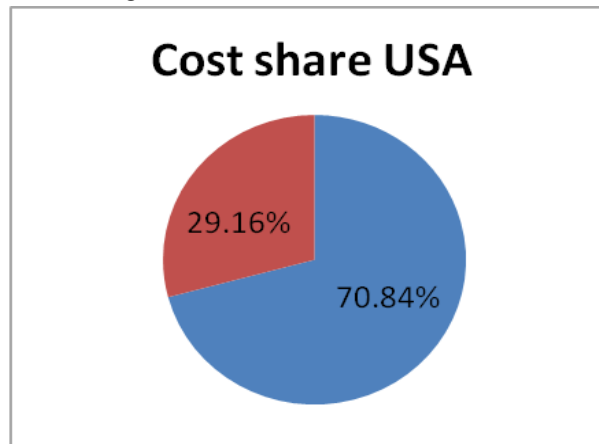

Figure 12: Cost share for the USA technologies

In the USA the capital costs are the most important, that is why the farmers need incentives from the state (to sell electricity) to install a digester.

The change of each of these costs will not have the same impact on the break-even price. Even a “correction” of the capital costs with the inflation rate (which is +26.6%⁸ from 2000 to 2010 in the USA) will have an impact on the break-even price and on the order of the most cost-efficient technologies (see Appendix XIII that also presents this change for Vietnam, where the inflation was +108%⁹ from 2000 to 2010).

⁷ World bank database

⁸ Source: <http://www.bls.gov/cpi/#tables> visited on the 25/07/12

⁹ Source: <http://datbank.worldbank.org/ddp/home.do> visited on the 25/07/12

C. Data research and results

a. Data used in this study

Many types of data are used in this model to calculate the emission reductions and the break-even prices (in \$/Mt output or in \$/head) (table 5).

Main data	Secondary data
<ul style="list-style-type: none"> • Capital costs (\$) • Lifetime • Change in labor costs • Change in Energy Revenue/Energy Savings • Change in livestock revenue (0) • Total regional baseline GHG emissions from livestock production (MMtCO₂eq) • Total regional baseline CH₄ emissions from enteric fermentation and from manure and total baseline N₂O emissions from manure (MMtCO₂eq) • Technical applicability enteric CH₄, manure CH₄ and manure N₂O (%) • Economic applicability (% , implied adoption rate here) • Percentage Change in CH₄ emissions from enteric fermentation and manure, percentage change in N₂O emissions from manure • Discount rate • Tax rate 	<ul style="list-style-type: none"> • Number of animals • Animal production (Mt) • Yield (kg/head) (the digesters do not change the yield) • Labor price • Labor hours per head with and without digester (and so the change in labor hour) • Electricity price (\$/kWh) • Biogas production (ft³/d) • Digester efficiency to collect, destroy and convert the CH₄ in electricity (%) • Share of the digesters

Table 5: List of the data requested in the model

These data are requested per country, per digester type (e.g. covered lagoon, fixed film, complete mix, plug flow, VACVINA, domes KT1/2, composite, polyethylene bag) and per animal type (dairy, pigs) for the base year 2010.

b. Data sources and application of the model

i. Data research

The main difficulty about the analysis of the model was finding year 2010 data, especially in Vietnam. In the absence of these data, a number of assumptions had to be used in combination with the available data to build the model in the USA and Vietnam.

USA

The capital costs (\$/head) have been found in a report done by USDA NRCS in 2007 [Beddoes *et al.*, 2007] and in a study done by Gooch in 2009 [Gooch *et al.*, 2009]. These reports were the most comprehensive sources found, so, for each technology, a mean has been estimated from the data in these sources. First of all, the values have been corrected with the inflation rate from 2006 to 2010 for the NRCS study, and from each start-up year to 2010 for Gooch *et al.* (2009) study, to be expressed in 2010\$. Then, to have these values in dollar per Mt output, they have been divided by the yield (kg/head), as they were expressed in \$/head, and multiplied by 1000. The yield has been calculated while dividing the production found in USDA National Agricultural Statistics Service¹⁰ (NASS) in 2010 by the number of animals which comes from the same source but has been corrected by not taking into account the number of animals in the farms that already have a digester (which does not change a lot the total number because the number of farms that have a digester is low). According to many studies on anaerobic digesters in the USA, the lifetime of the technologies is 20 years, which corresponds to the lifetime used in the USEPA model. No records are provided about the change in the labor cost. Indeed, it depends on the characteristics of the farm, the size of the digester and of the herd. But we can suppose than the extra number of hours needed for the digester has not changed from 2006. However, the dollar value changed and so, the labor price. Because of the lack of data about labor, we changed the labor price with the employment cost rate (since 2000 because in the initial model, the labor cost with the value of the dollar in 2000 has been used), which is +35%¹¹.

The revenue from electricity savings have been calculated using a formula presented in figure 7 (part II.A.b.) for each farm listed in the AgSTAR website. Then, a mean value has been used for each kind of digester, without taking into account the “extreme” values, namely the one that are too high and not representative compared to the other revenues. The biogas production used for the dairy farms is the one found in AgSTAR website for each farm. For pigs, there are fewer digesters currently used and the difference between these digesters can be big. In this study, the biogas production per head used will be the one given by RCM international LLC (a company that designs and builds some digesters in the USA) through the cost estimates they did for 940 and 2000 pigs. Indeed, this production per head actually does not change if the manure management system does not change and its value is 7.6 ft³/d/head. Thus, because of the lack of case studies for the pig sector, we will use this mean biogas production per head. Then the same methodology is used to obtain the revenue (equation 4).

The updated baseline emissions in this study are those published by the USEPA in 2011¹², for which we suppose the share of the enteric, manure CH₄ and manure N₂O have not changed from 2006 (no published information about the share of each GHG source within these new baseline). The implied adoption rate is the share of the digesters in the USA and will be discussed part II.D.a. This share has been found thanks to the record of the digesters by AgSTAR¹³. Sometimes a part of the gas can escape from the digester because of the leakage. The digester efficiency can thus be lower. The

¹⁰ http://www.nass.usda.gov/Quick_Stats/ visited on the 24/06/12

¹¹ http://www.nass.usda.gov/Quick_Stats/ visited on the 21/08/12

¹² <http://www.epa.gov/climatechange/EPAactivities/economics/nonco2projections.html> visited on the 24/06/12

¹³ <http://www.epa.gov/agstar/projects/index.html> visited on the 24/06/12

digesters could reduce 70% of the CH₄ from swine and 62% from dairy (66% in total, taking into account the efficiency to capture, combust and convert the CH₄ or biogas and the leakage) [AgSTAR, no date]. These figures have also been taken into account in another related study (Baylis *et al.* 2011). Thus, we will use them for the updated model. These values correspond to the “feasible farms” with more than 500 cows or 2000 pigs, but here, we will not take into account these thresholds, will suppose that all the farms could build a digester (actually, 87.6% and 90% of the digesters are in “feasible” dairy and pig farms respectively) but these thresholds will be studied in part II.D.d. Finally, the abatement potential can be calculated and expressed per Mt output, while dividing by the production level in the USA.

Vietnam

First of all, the digester technologies used in Vietnam has been found listed in a report by FAO on biogas in Vietnam [Bockel *et al.*, 2011], and in the description of a project by GFA Consulting group for the Asian Development Bank [GFA a, 2011]. Here, we will consider the dome digesters KT1/2, the VACVINA digester, the polyethylene bag and the composite digester (see Appendix XI for information about these digesters) for pig sector only because of the lack of information about dairy sector. The capital costs for pig farms have been found in an evaluation study [Hai Anh, 2010] (expressed in 2010\$) and thanks to information given by an expert (Pham Van Thanh, who is working for VACVINA in Vietnam) on biogas production in this country (average for a 7m³ digester, converted in 10m³ to be consistent with the information found in Hai Anh’s study). The yield has been calculated while dividing the production by the number of animals¹⁴ (total number in 2010 corrected by not taking into account the number of animals in the farms that already have a digester, but here again this number is quite low). We can have the capital costs per head, and then per Mt output thanks to the yield. The evaluation study of Hai Anh (2010) also gives the lifetime of each technology (20 years except for the polyethylene bag, 3 years). As in the USA, the labor hours do not change but the labor price has been changed with the consumer price index (+108%¹⁵ from 2000 to 2010, no information has been found about the employment cost inflation). The revenue savings have also been found in the evaluation study. As for the USA, the emission baselines are those published by USEPA in 2011. And we also suppose that the technical applicability does not change from 2006 to 2010. The implied adoption rates have been found thanks to the information given by experts (Pham Van Thanh and Matthew Carr from SNV Vietnam) on the number of each technology already available in Vietnam without distinction between pig and dairy farms. We suppose the total share of each kind of digester can be used as the share in the pig farms (see II.D.a. for explanation). Finally, another expert (Vo Chau Ngan Nguyen, lecturer at the Can Tho University, Can Tho city, Vietnam) who is working on this area assures that the efficiency of the digesters to reduce the CH₄ is 60-65%, without any distinction of the technologies. A report done by the Asian development bank in 2011 [GFA c 2011] explains that the leakage of the digester is about 10%, thus we will suppose that 60% of the CH₄ can be reduced. This value, as no publication has been done about that in this country, has been validated by another Vietnamese expert (Pham Ho Hai, vice head

¹⁴ Source: General Statistic Office of Vietnam http://www.gso.gov.vn/default_en.aspx?tabid=469&idmid=3 visited on the 21/08/12

¹⁵ Source: World Bank: <http://databank.worldbank.org/ddp/home.do?Step=1&id=4> visited on the 21/08/12

of the Department of Animal Health of the Research Institute of Agricultural Science for Southern Vietnam (IAS)). Here again the abatement potential per Mt output can be found while dividing by the production (found in the general statistic office of Vietnam).

ii. The MAC curves

○ The break-even price

Two break-even prices have been calculated. The first one does not take into account the tax. The second one gives the results after tax.

○ The MAC curves before tax

USA:

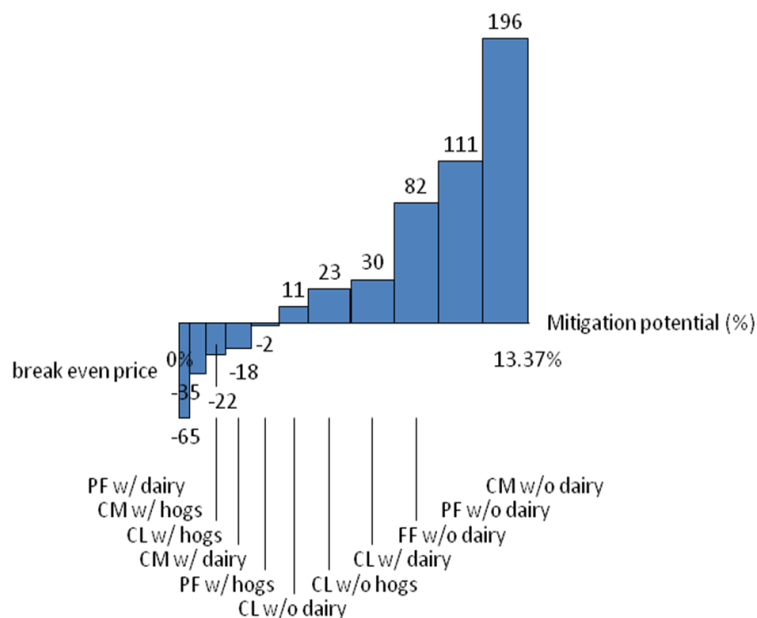

Figure 13: Results of this study for the USA

Figure 13 represents the MAC curves developed in this study for the USA. They present the results for 2010 considering the digesters that were available in 2010. First of all, some break-even prices (\$/tCO₂eq) are negative because the present value of the potential electric revenues can be much higher, in the whole period of 20 years, than the present value of the costs. The MAC curves show the cost of abating each additional unit of emissions. The break-even price represents the value at which the costs will equal the revenues. Thus, if electrical revenues are higher than the costs, then the break-even price will be negative. Thus, the technologies are presented first in the curves are the most cost-effective ones. The more the break-even price increases, the more expensive and the less cost-effective the technology is. We can see that this study found more cheap technologies than the USEPA model (see Appendix XIV) and that hog’s farms have the potential to be also cheaper according to our results (more technologies for hog’s farms found among the cheapest options).

While analyzing the order of the technologies, we can see that firstly, those with engines are the most cost effective and secondly, those applied to pigs are on average more cost-effective than those applied to dairy. Indeed, the digesters for pigs are cheaper. They can reduce more emissions per unit

of output than the digesters for cows (especially if we compare without taking into account the implied adoption rate). Moreover, the benefits linked to the electricity production show that the digesters with engines are more profitable than the ones without. Here we consider existing digesters, namely digesters built in feasible farms in a state where the electricity price is high enough to allow the building of a digester. The results show that the cheapest technologies for dairy farms are the plug flow and complete mix with an engine, which also correspond to what we can find on the field (indeed, among the digesters in dairy farms, these two kinds are the most represented). However, for the pig farms, the results show that the cheapest digesters are the complete mix and then the covered lagoon with an engine. Despite this, we observe that lagoons are the most commonly installed digesters (see part II.D.a.i.). We can see that the characteristics of the digesters (for example the maximal solid content), the climate conditions and the manure management, will play an important role in the farmer's choice about the digester type to applied. Therefore, the cheapest technologies are not necessarily the most applied.

The anaerobic digesters can decrease the amount of CH₄ emitted only, thus the abatement potential actually corresponds to the quantity of CH₄ reduced. Then, this potential (in percentage) can be express according to both the baseline of CH₄ from manure as well as total non-CO₂ emissions from livestock (figure 14).

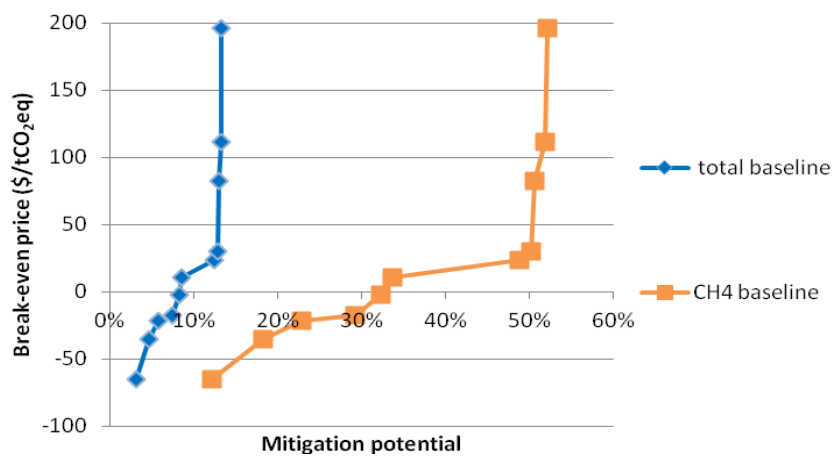

Figure 14: Comparison MAC curves before tax with the abatement potential relative to the total baseline (blue) and relative to the manure CH₄ baseline (orange) in the USA

Thus the incremental value of the abatement potential shows that 13.37% (23.26 MMtCO₂eq) of the total livestock non-CO₂ GHGs and 52.11% of the CH₄ emitted from agriculture in the US can be reduced thanks to this technology with the assumptions used for this model and considering that all the animals, and thus all the farms that do not have a digester yet, could have one. The assumptions will be discussed further.

Vietnam:

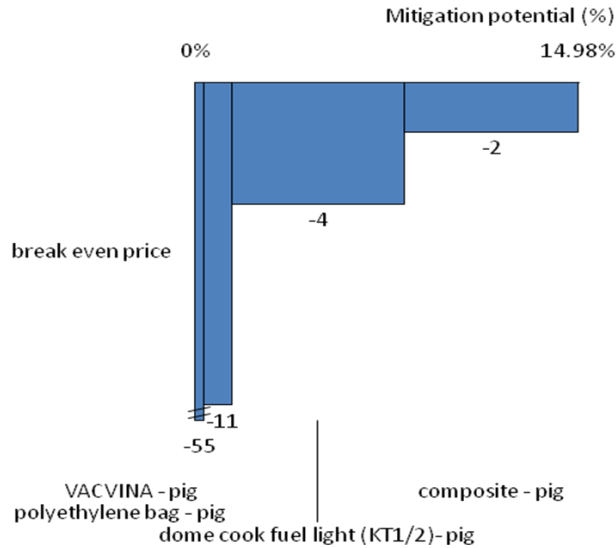

Figure 15: Results of this study for Vietnam

First of all, figure 15 shows that all the technologies are found to be profitable in Vietnam. In comparison, USEPA (2006) found that the lagoon digester had a positive break-even price in Vietnam (see Appendix XIV), whereas this option was not included in this study. A few lagoons do exist in Vietnam but not enough information, especially about the revenue from this technology, was available to be able to build the curves taking into account the lagoon. But as this technology is devoted to large farms only, the initial capital costs could be afforded only by big farms. The other farms will not have the funding, the place, or the number of animals required to run such a technology. Thus, it is likely that the break-even price can be positive for this technology.

The VACVINA digesters are the most profitable, whereas the composite is the least profitable technology and does not reduce a lot of emissions mainly because it is not widely applied over the country. The composite digester is similar to the dome digester, this is why their break-even prices are close. However, the domes contribute to much more mitigation. The polyethylene bag is one of the cheapest technologies in terms of capital costs, but is less efficient than the others and lasts only 3 years. Thus, with capital costs not much more higher than the dome and higher electricity savings, the VACVINA is estimated to be the most cost-effectiveness technology.

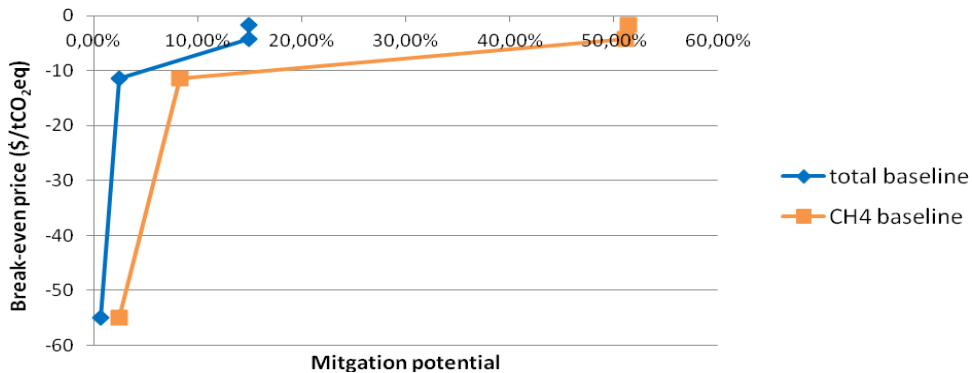

Figure 16: Comparison MAC curves from this study before tax with the abatement potential relative to the total baseline (blue) and relative to the manure CH₄ baseline (orange) in Vietnam

According to figure 16, the anaerobic digesters in Vietnam could reduce 14.98% (2.47 MMT_{CO₂eq}) of all GHGs from livestock and 51.43% of the CH₄ emissions from manure, while generating profits at the same time.

A comparison between the 2 countries is quite difficult. Indeed, the technologies, the materials, the farms aims while using such options (electricity and heat savings for the USA, especially heat savings and for cooking for Vietnam), and the economic situation of the countries are not the same. However, it seems that, according to the results, the Vietnamese technologies are cheaper than the USA ones and can be very cost-effective. This finding can be important for developed countries. Indeed, if their targets to reduce their emissions under the Kyoto protocol is quite high, then, they will need to buy credits from some developing countries that can maybe more easily (because of the material prices, labor prices, help from national programs) reduce their emissions. This is why the results found in this study about the effectiveness of the Vietnamese technologies may be of interest to some countries, such as the USA or the countries that have ratified the Kyoto Protocol, which could invest in these technologies to reach their emissions reduction targets.

o The MAC curves after tax

This study has been done without taking into account the tax rate. If we take this rate into account, then we will have new curves (figure 17), and a new order of the technology.

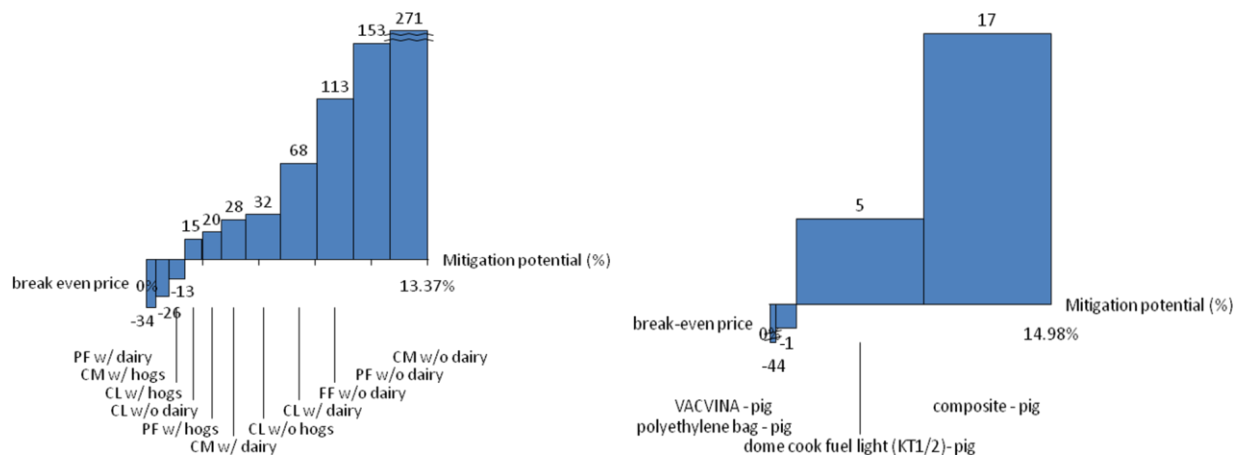

Figure 17: Results of this study after tax USA (left) – Vietnam (right)

To simplify the calculations, we studied the results without tax rate (0%). This latter has been fixed at 40% here. This change has no impact on the abatement potential but it does affect the break-even price (\$/tCO₂eq). The consideration of the tax or not will lead to different results.

First of all, in the USA, all the prices increase if the tax rate is taken into account, which is quite an obvious result. Indeed, we can find more cheap technologies without tax (5 negative prices) than with a tax rate (3 negative prices). Moreover, 60% of these cheap options without tax are for the pig farms, whereas 67% of them when we take into account the tax rate concern the pig farms. That means that after tax, the pig farms appear to have the biggest potential to be more profitable farms than the dairy farms. Finally, the order of the technologies changes. This change can be explained by the formula to calculate the break-even price. Indeed, the fact of taking into account the tax rate will add a new term in the break-even price calculation and decrease the denominator of the first term.

Then, the evolution and classification of the technologies prices will depend on the value of the other parameters such as the capital cost.

For Vietnam, we could see that before tax, all the technologies are cheap (negative break-even price, see figure 15). After tax, all the prices increase but the order of the technologies does not change. We can especially see that the VACVINA digester represents, after tax, a good option to reduce the greenhouse gases emissions and should maybe in the future, have a higher market share so that it will contribute more to the GHG mitigation.

Thus, these results, along with previous MAC studies, could help policymakers to find some technical and economic solutions to decrease the GHGs emissions from farms and fight against climate change. For example in the USA, for a C price (incentives) of \$US 27/tCO₂eq (may be lower in other countries like Japan or EU [Golub *et al.* 2012]), about 15 MMtCO₂eq of gas emissions could have been reduced in 2010 (8.6% of the CH₄ manure and enteric emissions, 33.6% of the CH₄ manure). With these results, we can see that if the incentives are just a few dollar higher (for example, \$32/tCO₂eq), the quantity of GHG (especially CH₄) reduced could have been 5 MMtCO₂eq higher. In Vietnam, we saw that the VACVINA represents a good option to decrease the GHGs. But they are still not very numerous in the country. Thus, it could be possible to create incentives to encourage the building of the VACVINA digester (cheaper), so that their market share will increase, along with their total potential to decrease the GHGs.

- The abatement potential

This potential, as explained before, depends on 4 parameters (the baseline, the technical applicability, the implied adoption rate, the efficiency to reduce the GHGs). No new data has been found for the technical applicability for pigs and cows, but the 3 others parameters have been updated (except the baseline enteric emissions because we are working on the manure emissions). The following curves present the results for the abatement potential of each technology and the total potential for the USA and Vietnam.

USA:

Because of their different distribution (share), the technologies do not have the same potential to decrease the GHGs (figure 18):

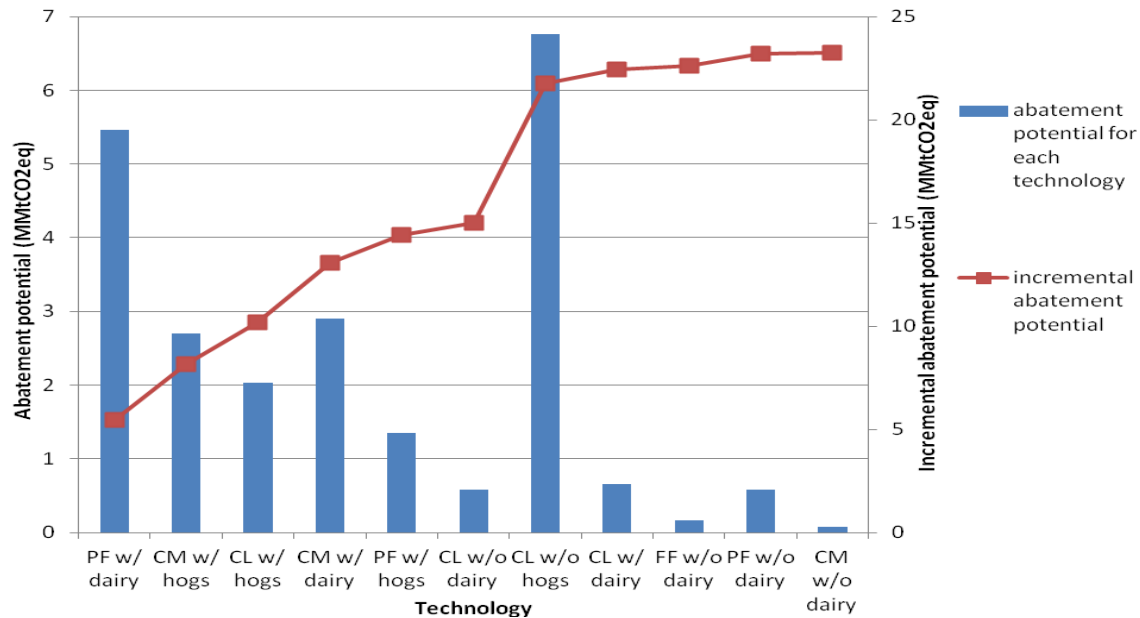

Figure 18: Individual and total abatement potential

We can see that, the 1/n assumption is first not realistic, and then could have given credit to technologies that does not play an important role in the abatement potential (fixed film digesters) and underestimate the number of other technologies and so the abatement potential of these technologies (plug flow digesters with engine for dairy farms and covered lagoons without engine for hogs farms). This is why a discussion will be devoted to this assumption in part II.D.a. As note, the observed distribution of each technology in 2010 is used to determine the allocation of digesters in the country.

We can see that the shape of the incremental abatement potential curve is not a linear curve, unlike the incremental curve based on the USEPA (2006) results, which distribute the share of each technology homogenously (see Appendix XIV for USEPA’s results). This study found that 23.27 MMtCO₂eq could have been avoided in 2010 (which is a little bit less than the agricultural CH₄ emission of Venezuela in 2005), whereas the USEPA found that 28.42 MMtCO₂eq can be avoided thanks to the technologies (which is a little bit less than the total CH₄ emission of Germany in 2005). The difference is about 5.15 MMtCO₂eq (-18%), which almost corresponds to the total CH₄ emission from agriculture in Denmark in 2005¹⁶. Thus, these differences are quite significant.

As mentioned, this study also found that 13.37% and 52.11% of the total (enteric and manure) or CH₄ manure only baseline could have been reduced respectively, which is actually lower than USEPA’s results. This latter may have overestimated the abatement potential of the technologies in 2010.

¹⁶ Source: World Bank visited on the 26/07/12

Vietnam:

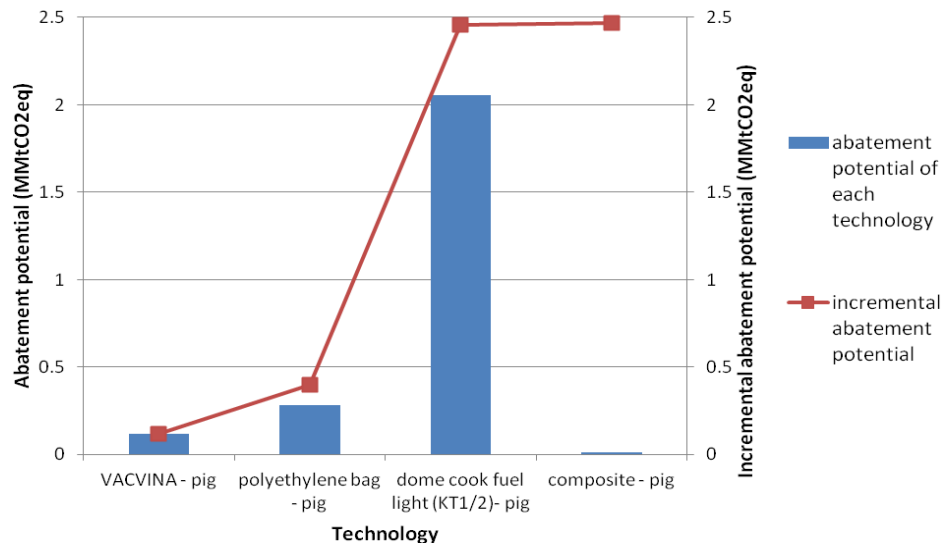

Figure 19: Individual and total abatement potential

In Vietnam too, some technologies do not appear in the USEPA model (composite and VACVINA) and some have not really been found in the reality (lagoon) or have not been taken into account in this study (dairy sector). Here again, the most interesting difference is the adoption rate. Indeed, the technologies considered here are not the same and the curves presented in figure 19 represent the share of each technology in reality: small role to the composite and VACVINA digesters, but the curves show the real potential of the dome and the plastic bag (even if it is underestimated for the plastic bag especially). USEPA’s model found that the Vietnamese digesters in pig farms could have reduced 2.34 MMtCO₂eq in 2010 (see Appendix XIV), which is very similar to this study’s results.

Finally, the results shows that 14.98% and 51.43% of the total (enteric and manure) or CH₄ manure only baseline could have been reduced respectively in 2010, which is also lower compared to USEPA’s results, but here the technologies are not exactly the same, the comparison is more difficult.

D.Sensitivity analysis and more details about the model done in this study

This paragraph will first discuss the strong assumption made by USEPA (2006) about the homogeneous distribution of the digesters and secondly try to prove, with some examples, why having precise data for each parameter is really important to build a model as close as possible from the reality and to what extent a change in one parameter could affect the results. Therefore, we will look closer to: the discount rate, the farm size, the adoption of the technology.

a. Distribution of the digester: the 1/n assumption

i. Share of the digesters

USA:

In the USA, only 191 digesters are currently working (2012) whose 175 have an engine for electricity or heat generation. Among them, 157, 23, 4, 2, 5 are in dairy, pig, poultry, beef and mixed dairy-pig farms respectively. In this study, we will analyze the situation in 2010 for dairy and pig farms. At this time there were 134 digesters in the dairy farms and 20 in the pig farms¹⁷. Thus this technology is for the moment not very well spread in this country, even if it has proved its efficiency and if many new projects are predicted or have already started about these digesters. The market potential to implement them is quite big.

Again, a very strong assumption made in USEPA (2006) concerns the repartition of the digesters in a country. If n technologies exist, then each one of these technologies is assumed to be applied equally, using a share equal to 1/n. Thus, the lack of precise data can be overcome and all the technologies can be considered without economic consideration that could lead to the selection of only the most cost-effective option. The observed share of each technology in 2010 is the one given in figure 20:

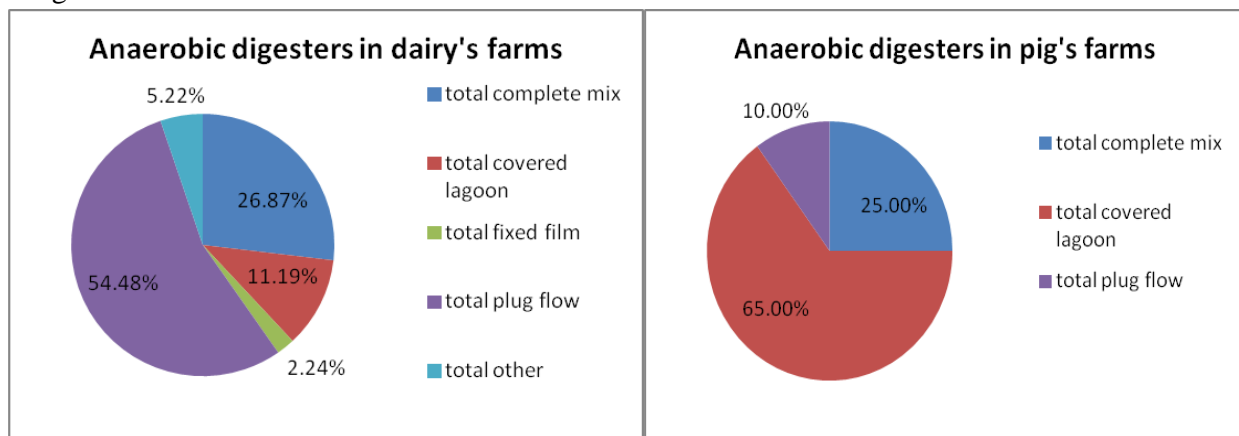

Figure 20: Share of each kind of digester in the US farms (source: USEPA AgSTAR 2012)

Thus, the assumption 1/n is not realistic because most of the digesters in a dairy and pig farm are plug flow and covered lagoon respectively (because plug flow digesters need a high solid content, which can be provided only by dairy cows, and because lagoons are the cheapest technologies and they need a low solid content; the choice of a type of digester by a farmer depends on a lot of parameters which will be discussed below). Moreover, the fixed film digesters currently do not exist in a pig farm and we can find only a few of them in a dairy farm. This results also show that only three types of digesters exist for pigs whereas at less 5 types exist for dairy (the “other” types are often batch reactors). Finally, among the most common type of digesters for pigs, the covered lagoon, 77% of them do not have an engine to produce electricity, which implies that selling electricity from a pig farm is not profitable and that farmers decide to build a digester for other reasons than trying to make a benefit from the electricity selling, for example, save money from heat,

¹⁷ Source: <http://www.epa.gov/agstar/projects/index.html> visited on the 29/06/12

odor control or using the digestate as a fertilizer (45% of the digesters found in the pig farm in 2010 have an engine). However, 90% of the most common digester for dairy, the plug flow, have an engine (86.6% of the digesters in a dairy farm have an engine). So selling electricity appears to be more profitable for dairy farms than for pig farms which can explain why only a few digesters exist in a pig farm. The manure production per day is 83.5lb/1000 lb of dairy cow and 67.3lb/1000 lb of swine¹⁸. Werner *et al.* in 1989 claim that one cattle can produce about 9-15kg of dung (0.4m³ gas) per day and one pig can produce 2kg of manure (0.15m³ gas) per day. Thus, not enough manure is produced by pig farms to have an excess of electricity. Pig farms usually do not produce enough energy to sell the excess power out on the grid at a rate that could help them to be easily refunded or even to exceed the investment, the compensation is not enough. However, dairy farms can produce much more power than they really need in the farm and so, they can have an interesting energy revenue or savings from the selling of the electricity.

Vietnam:

The share of each kind of digester is also different, as explained in figure 21:

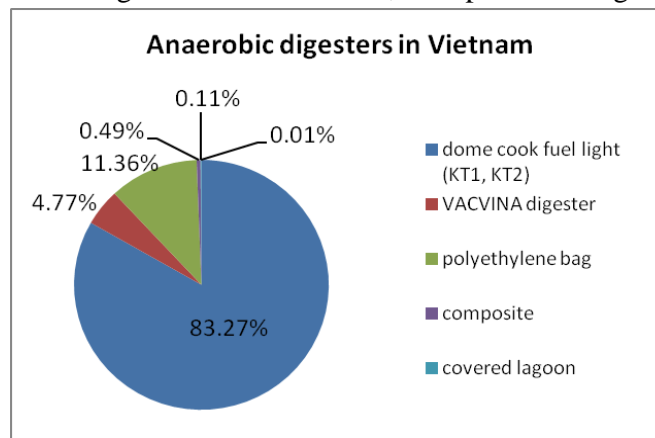

Figure 21: Share of each kind of digester in the Vietnamese farms (source: experts)

In Vietnam, as explained part II.B.a, the technologies are not the same (see Appendix XI for information about the Vietnamese digesters). Most of the technologies in this country are domes KT1 in the North or KT2 in the South due to their affordability. Indeed, they represent 83.27% of the digesters. However, we mentioned that the polyethylene bags number is difficult to quantify, thus they are very likely to be more numerous than the domes. The value here corresponds to what an expert and a researcher who is working for VACVINA (which install the digesters) has conveyed. The composite and the lagoon represent only 0.49% and 0.11% of the total digesters in the country respectively. The rest (0.01%) corresponds to another type of digesters which will not be studied here. Another estimation is that, while taking into account the many plastic bags that there could be in the country, the number of digesters in the pig farms would be about 2 million (but of course it is impossible to check). (Source: La Van Kinh from the Vietnam Academy of Agricultural Sciences).

¹⁸ http://www.nrcs.usda.gov/wps/portal/nrcs/detailfull/national/technical/nra/rca/?&cid=nrcs143_014154 visited on the 29/06/12

Therefore, it is quite important to understand what drive these figures. Indeed, if the assumption $1/n$ is inaccurate, the alternative assumption that the cheapest technology is the most applied is not really helpful neither. Similarly the assumption that the observed distribution for current adopters is representative for the entire country, as assumed in this study, is also imperfect. Ideally, bio-physical parameters and other adoption constraints need to be taken into account. The potential impact of selected biophysical factors on adoption is discussed later in section II.D.a.iii.

ii. *Effects on the MAC curves*

USA:

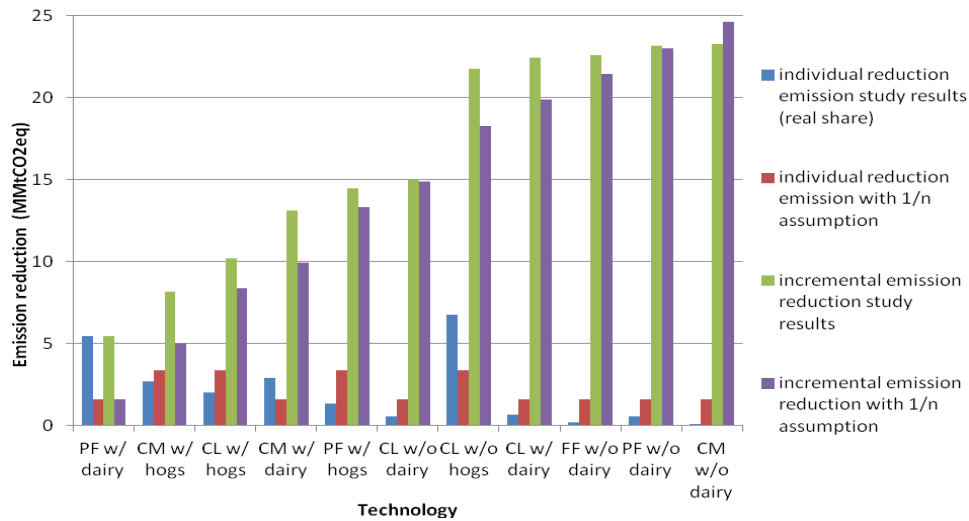

Figure 22: Comparison observed share- 1/n distribution for each technology in the USA

CM = Complete Mix, PF = Plug Flow, FF = Fixed Film, CL = Covered Lagoon, w/ = with an engine for electricity production, w/o = without an engine for electricity production.

The change in the share of each technology will have an impact on the abatement potential but not on the break-even price, thus the classification of the technologies will not change. Indeed, we do a one-by-one comparison of options without taking into account the economic applicability. The options in figure 22 have been classified in an ascendant order of break-even prices.

Many differences can be observed between the observed share and the homogeneous distribution of the technologies assumptions. We can see that most of the time, the reduction potential of each digester is overestimated with the $1/n$ assumption and that the total incremental value of the reduction potential is lower with the real distribution (13.4% instead of 14.1%, or 23.27 instead of 24.61 MMtCO₂eq). Thus, the interpretation that we could do with a homogeneous assumption cannot always be applied in the reality. For example, the plug flow digesters with an engine for dairy farms actually reduce much more GHGs than what could be predicted with the homogeneous assumption because the share of these digesters is higher than the other ones (49.25% in reality, 14.29% with the $1/n$ assumption). On the contrary, the complete mix digesters without engine in dairy farms contribute less to the GHGs mitigation because they are not often use in the US (0.75% in reality, 14.29% in the model). Thus we can discuss the efficiency of a global model at a country scale because of the need to take into account the fact that farmers will prefer one type of digester because it is more efficient or less expensive for example.

Vietnam:

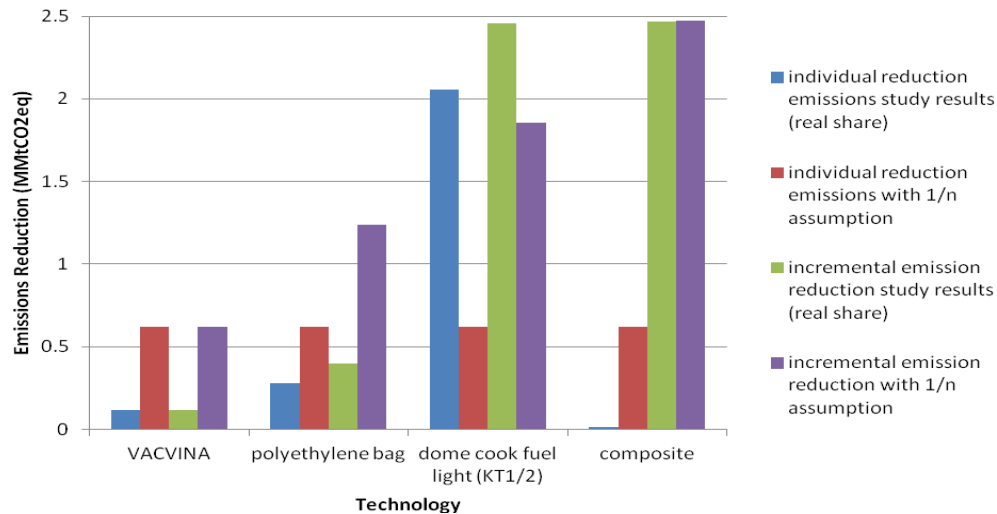

Figure 23: Comparison observed share- 1/n distribution for each technology in Vietnam

For Vietnam, the same kind of analysis can be done except that the technologies considered here are not very numerous (only four) and are not the same than the one found in USEPA (2006). The dome digester and the polyethylene bags are technologies studied here and in USEPA (2006) and found in the reality. But the composite and VACVINA are new technologies. Moreover, the flexible bag, covered lagoon, and the digesters for dairy are not taken into account here because of the lack of data about these technologies. Thus, the MAC curves in this study will actually lead to more abatement potential for the dome because of their share in the country and lower ones for the 3 other technologies (figure 23). The total incremental potential however, is found to be almost the same if we consider the 1/n assumption or the observed share.

iii. Farm profile and scale

Whereas the previous section explained the difference between the digesters distribution and its impact on the MAC curves, especially on the emissions reduction, this section will provide some information to explain the different repartition of the digesters across the country (number of animals, climate and digester distribution according to the states/regions characteristics).

USA:

o The number of animal

The total number of animals that digesters could be applied to in the USA is estimated to be 4 898 789 dairy cows and 55 360 530 pigs. Indeed, in 2010 there were 9 117 500 dairy cows and 64 778 500 hogs in the USA¹⁹. AgSTAR estimated that only the pig farms with more than 2000 pigs and the dairy farms with more than 500 cows have the technical requirements to build a digester (affordable construction costs, energy price, management practices), which actually corresponds to

¹⁹ Source: USDA NASS, <http://quickstats.nass.usda.gov/> visited on the 24/07/12

only 12.3%²⁰ of the pig farms and 3% of the dairy farms. 56.6% of the dairy cows and 86% of the pigs are in such farms²¹. This observation shows that considering all the farms in the USA as a potential farm to implement a new digester is unrealistic. It does not mean that the little farms cannot have a digester, it means that it is not advised to build a digester in such farms. Thus 5 160 505 dairy cows and 55 709 510 pigs are in the farms suitable for a digester. If we put apart the number of farms (and so animals) that already have a digester, 4 898 789 dairy cows and 55 360 530 hogs should be considered in the model and study. The largest farms could afford a break-even price lower than the smallest farms. However, if we take into account the AgSTAR results, then we do not take into account the small farms that could have a digester even if it is not advised. Moreover, distinguishing the small and large farms requires enough data about the capital costs and revenues for each kind of farms, for dairy and pigs, and for each type of digester with and without an engine. If this difference can be made for dairy farms, it is not possible for pigs. Indeed, 90% of the digesters in the pig farms are fed by more than 2000 pigs. So there is not really case studies for the little pig farms. Finally, we could wonder what will be the aim of this study if we only take into account the farms that are already “feasible” for the building of a digester, no matter what is the carbon price. So, we will keep the total number of animal for the general study (less the farms that already have a digester, even if their number is quite low), will discuss the difference between the small and the large farms in the US dairy sector in part II.D.d., and give an example of a cost analysis for a 940 hogs farm (the mean number of pigs in a pig farm in the US is about 940-960 according to USEPA database) in Appendix XV. Thus, the farm size plays a role in the digester choice and distribution.

A lagoon is less efficient than another digester to produce electricity because it is not heated. So, to be efficient, it could first need more animals than the plug flow and complete mix (without any consideration of the climate). This can explain why, according to the distribution of the digesters in the USA and the cow and swine inventory (see Appendix XVI), we can observe that most of the lagoons in the dairy and swine farms are in California and North Carolina (see below), the leader states for dairy and swine farms respectively and where we can find very large farms (91% and 75% of the milk cows and pigs are in farms with a herd size of at least 500 cows in California or 5000 pigs in North Carolina in 2007 respectively). However, this observation is an assumption, no real figures or a minimal number of animals have been found about this. It is even more true for the pig sector, which produces less manure per head per day. Thus, the lagoons can be found in North Carolina, the leader state for pig farms and where 75% of the farms had more than 5000 heads (2007).

- The digester distribution

We saw that the share of the digesters is not the same for all technologies in the USA, but actually, not every state has the required conditions to build such a technology. Indeed, it appears that more digesters can be found at the East of the USA and, above the 40th parallel, no lagoon can be built for energy production because of the low ambient temperature (the more the temperature is high the more CH₄ can be produced) [AgSTAR, no date]. Indeed, the tables 6 and 7 show how each type of digester for dairy and pig farms is spread among the states:

²⁰ Source: Pork Checkoff 2012

²¹ Source: USDA NASS

Plug flow	Covered lagoon	Complete mix
<ul style="list-style-type: none"> • Wisconsin (23.29%) • New York (15.07%) • Vermont (12.33%) 	<ul style="list-style-type: none"> • California (46.67%) • New York (33.33%) 	<ul style="list-style-type: none"> • Pennsylvania (22.22%) • Wisconsin (19.44%) • New York (16.67%)

Table 6: Dairy digester spread among states

The covered lagoons need less than 3% of solid, a warm climate (because it is a non-heated technology) and low water intake. California is the first state in the US for dairy production, has a quite high electricity price compared to the other states (13ct/kWh²²) and we can find large operations (more than 500 cows) and a warm climate. Finally, the lagoons are cheaper than the other digesters. Thus, most of the lagoons for dairy farms are in California.

Wisconsin is the second state for dairy production, the electricity price is 9.78ct/kWh (like the mean price in the USA) and the climate is not really warm (so building a lagoon is not possible). Finally, the plug flow is supposed to be cheaper than the complete mix and needs a high solid content (more than 10%, which is possible to obtain only with dairy manure). This is why a lot of plug flow can be found in Wisconsin especially.

Finally, Pennsylvania has a high electricity price (10ct/kWh) and is especially rural, which can lead to odor issues. Thus more complete mixed will be found in this state.

A company that provides the digesters (RCM international) will not install a lagoon in New York unless for odor control and biogas burn to have a carbon credit. New York has a cold climate so the digester will have to be heated during the winter, which is why the plug flow and complete mix digesters are the main types of technologies built in New York. Moreover, the manure has to be collected as dry for the complete mix. So this company would only consider building an anaerobic digester system in New York farms which have dry manure collection systems (scrape or vacuum). In the situation where a farm in New York uses a lot of water to collect manure (flush manure collection), a covered lagoon would be appropriate, but the manure would be too diluted to be kept warm in the winter and the digester would not produce much biogas in freezing winter. So, a covered lagoon system in New York would not be productive or profitable. It would only be installed if the farm wanted to flare the gas. However, there are no grants for projects that do not produce electricity and the value of carbon offsets will not help to pay for the capital investment of this kind of project.

So it appears that the climate zone will be an important factor to take into account for the implementation of the technology (see Appendix XVII the climatic zones in the USA and the digester distribution in 2012).

Plug flow	Covered lagoon	Complete mix
<ul style="list-style-type: none"> • Pennsylvania (100%) 	<ul style="list-style-type: none"> • North Carolina (30.77%) • Texas (15.38%) 	<ul style="list-style-type: none"> • Wyoming (40%)

Table 7: Swine digesters spread in the USA

North Carolina is the first state for pig production. They have a low electricity price (8.7ct/kWh) but an important manure management program because of water quality and odor issues and a mean

²² Source: <http://www.eia.gov/electricity/state/> visited on the 24/07/12 (all the electric rates come from there)

annual temperature of 15 C° (which is considered as warm). Moreover, covered lagoons are cheaper and they need only between 0 and 3% of solid content (possible with pigs). Thus a lot of covered lagoons (without electricity production) can be found in North Carolina.

There are only two plug flow digesters and five complete mix digesters for pig in the USA, thus studying their repartition is not really relevant.

So, for dairy and pigs, the temperature is an important factor for the implementation of the covered lagoons which are not heated. Indeed, above the 40th parallel, it is difficult to run such a digester in an efficient way because of the low temperature. Building a lagoon in the northern part is possible but they cannot be built for economic reasons (selling the electricity). So we could say that the lagoon with electricity production could be apply only in 50% of the US territory, whereas the plug flow and complete mix could be applied everywhere (just considering the weather factor). Then we have to consider the management of the farm (amount of water used, collection of the manure...).

In a lot of states, no real incentives for electricity exist to help farmers to pay the investment, which is a problem for pig farms because they do not produce enough energy. Thus the digesters are mainly based in the states where the electricity price and the farm size are high (it is also the case for dairy farms). And indeed, we can see that 87.6% and 90% of the digesters in the dairy and pig sectors in 2010 are in farms with more than 500 cows or 2000 pigs respectively.

The choice of the digester type and its efficiency also depends on the farm type (the bedding type used at a dairy for example can affect the digester designs that will work the best), the storage type (solid, slurry, lagoon), the type of manure stored, which are different among the states. Thus, the extrapolation of mean results for the USA is difficult because they cannot be applied to every farm.

Depending on the temperature variation, the repartition of the animals in the country, and the farm size, new rules can be made about the implied adoption rate. This time, it will not be a percentage of the whole quantity of technologies; it will be a percentage of the number of animals. Here, we will build new rules to obtain a geographic distribution of the digesters that have been studied within the model. The methodology is presented in Appendix XVIII. The aim is here use an implied adoption rate based on bio-physical parameters especially and to observe the difference with the homogeneous distribution assumption and the real share observed in 2010.

The table 8 summarizes the new rules that could be taken into account:

Lagoon with engine		Lagoon without engine		Plug flow with engine		Plug flow without engine	Complete mix with engine		Complete mix and fixed film without engine
Dairy	Swine	Dairy	Swine	Dairy	Swine	Dairy	Dairy	Swine	Dairy
33.6%	21.3%	7.1%	10.1%	23.6%	7.5%	4%	23.6%	61%	4%

Table 8: Geographic share of the digesters in the USA

Now, we can compare the results for 3 case studies: using the real data about the share of each kind of digesters in 2010 (results of this study), using the assumption of 1/n for each technology, using the geographical distribution explained above. These 3 options will change the abatement potential but will have no effect on the break-even price of each individual option. Figure 24 represents what we can observe (before tax):

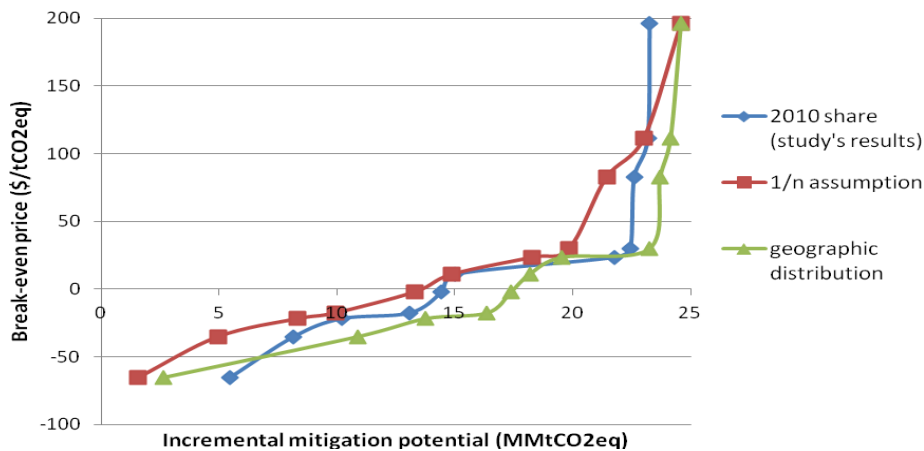

Figure 24: Comparison of the MAC curves under 3 scenarios in the USA

Here again, it appears that building new rules to consider a geographic distribution of the technologies a little bit more based on bio-physical parameters such as the climate or the localization of the animals, leads to many differences compared to the homogeneous distribution assumption. Indeed, the shape of the curves, and so the evolution of the incremental mitigation potential, and the amount of gas reduced for a given break-even price are not the same. However, the total mitigation potential using this method appears to be almost the same than the one found with the 1/n assumption. Here for example, if we consider a carbon price of \$50/tCO₂eq, we can see that the 1/n assumption gives the lowest amount of gas reduced whereas the geographic distribution leads to the highest one. Thus, the implied adoption rate appears to be really important to be able to predict the potential of a technology to decrease the GHGs emissions, and to present correct estimations or predictions to policymakers. The fixed film has been represented here as a heated digester, quite expensive, with a low solid content. Thus they could be spread over the country as the complete mixed. However, the difference between these 2 technologies is the manure management. Indeed, plug flow and complete mixed are not feasible for the flushed manure systems, on the contrary of the lagoon and the fixed film. For example, in Florida, the manure is handled that way, so the best technologies in this state will be the lagoon or the fixed film. However, as it appeared to be quite difficult to do a geographic distribution of the manure management practices, this parameter (that could be important), has not been taken into account here.

This study has been done for the whole USA. However, with regard to what has been explained above, the different characteristics of each state (climate, electricity price, programs for digesters) and of each farm (number of animal, manure management, budget, odor problems, etc) prevent the extrapolation of one state profile to another one and thus, the general results found for the USA may not be applicable to every states.

Thus, it appears that the implied adoption rate of each kind of technology depends on a lot of factors: the herd size, which contributes to define the digester size; the temperature or the weather, which contribute to explain where some kind of digesters can or cannot be built; the environmental issues, such as the manure management or the odor control; the digester efficiency (CH₄ collection efficiency), that appears to be 75% for the non-heated digester (lagoon) and 99% for the heated one

(plug flow and complete mix) [Lazarus *et al.*, 2011]; the economic factor, with the capital costs of the digesters and the electricity price. It is important to consider all of these bio-physical parameters in order to not consider the fact that the cheapest technology will be the most applied. These parameters will all contribute to determine an implied adoption rate for each kind of technology.

Vietnam:

Much less information exists about the farm profile and the scale and about the dairy sector in general. The choice of purchasing a digester in a developing country depends on several parameters. First of all, the investment costs. The farms in Vietnam are small for most of them, thus they cannot afford an expensive digester. Moreover, the farmers and technicians need to learn how to operate and maintain this kind of technology. The registration can be long (3.5 months), which can discourage some farmers to build a digester. The soil has to be good (a poor soil condition and rain problems could lead to a fail of the digester). Finally, the farmers need to have enough manure to fill the biogas plant (an excess of manure will also lead to a low efficiency). [Nguyen Quang Dung, 2011]

○ The number of animals

In 2010, the number of pigs were 27 373 100 and they were especially in the North Central of Vietnam and in the Red River Delta (40.4% and 26.7% of the total number of pigs) respectively²³ (see Appendix XIX for the Vietnamese regions).

Over the 6 331 941 households that raise pigs, 55.73% have 1 or 2 pigs, 27.64% have between 3 and 5 animals, 14.89% have between 6 and 20 pigs and 1.75% have more than 21 pigs [General statistics office of Vietnam, 2007]. Thus for the pig farms, a lot of households cannot use a large scale digester like the lagoon. Only the largest farms can but they are only 17 000 and among them only a small number (0.3%) have such large scale digester. So, almost all large scale farms could have a digester. And a lot of farms can only use the plastic bag digester or the dome with a low size. [Source: Pham Van Thanh]

Pig farms can be found especially in the North of Vietnam, where most of the KT1 and composite are also found (10000 composite units in 2011 [Nguyen *et al.*, 2012]). Small farmers have 80% of the pig population. Indeed 75% of the pig population is in a traditional pig production (1-10 head), which is a common practice everywhere (slaughter weight: 50kg/head). 10-15% of the pig population is in a family farm (10-30 sows or 10-50 fattening pigs), which is popular in Red River Delta (slaughter weight: 70-75kg). And 10% of the pigs and 20-25% of the pork volume is in a pig farm (more than 20 sows or more than 100 fattening pigs), whose number increases especially in the Red River Delta, the South East and the Mekong (slaughter weight: 80-85kg) [GFA b, 2011].

6 pigs or 1 cattle are the minimum to produce enough cooking fuel for a 6 member family. Indeed, a 50 kg pig produces 0.27m³ of biogas daily and one person needs 0.3m³ per day for cooking, thus, a family of 6 persons maximum needs 6-7 pigs (15-18kg of manure) [Nguyen, 2005]. If this family has less than 6 pigs, then it will have some cows (1 for dome, 3 for VACVINA). In 2009, the households had an average of 26.7 pigs and 0.5 cattle [Huu Luu *et al.*, 2011].

²³ Source: General statistic office of Vietnam http://www.gso.gov.vn/default_en.aspx?tabid=469&idmid=3 visited on the 24/07/12

○ Digester distribution

According to the biogas user survey 2010-2011, most of the digesters are in the North Vietnam (88.86% among the regions studied) and small-scale but some of them are large scale. It is the case for the covered lagoons. However, those installed in the North are not efficient and highly seasonally variable (covered lagoon needs warm climate, but the weather is quite cold in the North Vietnam during the winter, thus at this period, the digesters does not produce a lot of biogas) (see Appendix XX for a picture of a lagoon that does not work). According to the low carbon agricultural project draft [GFA, 2012], the number of large farms in 2009 was 7 552 (36.3% of the total number of farms found in the General statistic office of Vietnam), whose 1 186 had a biogas plant (15.7% of the large farms). The KT1/2 and VACVINA digesters need between 10 and 30 animals, the composite need 10-15 animals, the plastic bag 5-10 and the lagoon between 1000 and 5000 [expert judgment].

The distribution of the livestock determines the distribution of the digester's one (see Appendix XIX for 3 Vietnamese regions comparison). As the weather condition in the North is quite variable, the development of the lagoon option is not easy. However, it seems that the plastic bag could be found everywhere.

Here again, the repartition of the digester over the country is heterogeneous because of differences of climate, livestock inventory, availability of the materials (some are popular only in the South) for the digester building, the choice of the farmers among the digester types (sometimes simply driven by the choices of other farmers in the area), the digester costs. However, not enough information has been found to realize a geographic distribution like the one that have been done in the USA. However, we can compare the MAC curves between the 2010 share of the digesters and the 1/n assumption. As for the USA, the shape of the curves, and so the evolution of the incremental mitigation potential, and the amount of gas reduced for a given break-even price are not the same (see Appendix XXI).

○ The payback period and efficiency of the digesters

The choice of a digester instead of another one also depends on the payback period when many options are available. If this period is higher than the lifetime of the digester, then of course, the building of this digester does not worth it. The Appendix XXII explains the financial analysis of the technologies in pig farms available in Vietnam. Even if the payback period is shorter in the plastic bag case, this kind of digester is much less efficient than the dome according to the farmer and the lifetime is much more shorter than the other digester types. Moreover, the VACVINA digester produces 4% more biogas than the dome (2.25 m³/day for the dome, 2.34 for the VACVINA). [Huu Luu *et al.*, 2011]

b. The discount rate

The discount rate is used to depreciate a future value and to determine its present value. The formula is this one (figure 25):

$$P_0 = \frac{P_t}{(1+i)^t}$$

Figure 25: Present value

With P_0 = value at the initial time, P_t = future value, i = real interest rate (or discount rate), t = time

It reflects the time value of money (theory of time preference, an investor would prefer having cash now rather than waiting for some years), and the risk (uncertainty).

This rate has been fixed (10%), but in reality, some countries could choose to have a lower one (because it is an environmental study so they are expecting long term results with slow growing benefits, which will increase the net present value), other would prefer a higher one (to have a higher and faster payback). A lot of studies have been done about anaerobic digesters cost-effectiveness, but not the same discount rate has been applied. The choice of this rate is an arbitrary decision and depends on the vision the author has of the study he is doing. If the aim is to work on a social, environmental study, then the discount rate should be low. On the contrary, if the financial motivations are more important than the social ones, then a highest rate will be chosen. For the USA, among many studies that have been done about carbon price and anaerobic digesters ([Baylis *et al.*, 2011], [USEPA, 1999], [Bishop *et al.*, 2010], [Mueller, 2006], [Hurley *et al.*, 2006], [Jackson, 2006]), we can see that quite often, the discount rate chosen is quite low, which suggests that the social and environmental vision of such projects could be important. We can observe the consequences of a change of the discount rate, fixed at 7% for example, in the MAC curves shape (figure 26):

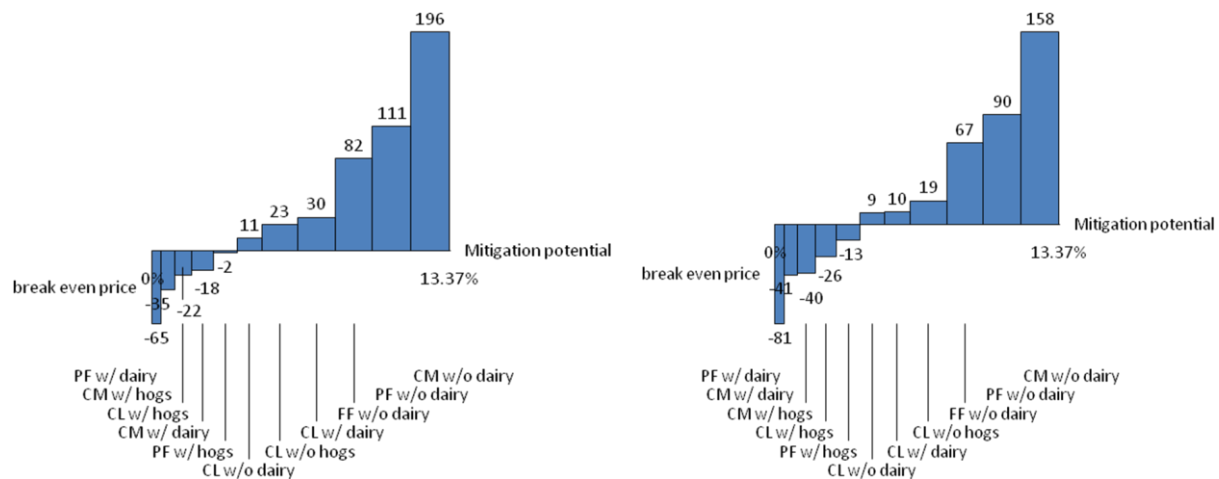

Figure 26: Effect of the discount rate change in the USA (model left, change discount rate right)

The change in the discount rate will not change the abatement potential but will change the break-even price P . For a same level of reduction the break-even price is lower with a lower discount rate. Indeed, this can be explained with the formula expressed part II.A.b. The discount rate DR decreases so the net present value related to increases. The denominator increases, so the break-even price decreases (the other terms are fixed). It looks like the assumptions done about the discount rate could underestimate the cost-effectiveness of the mitigation options.

Moreover, when the discount rate changes, the order of the most cost-efficient technologies will change too. Indeed, the first cost-effective technology is still the same, and so are the 3 last ones, but the rest of the options are re-ordered. In this case for example, the covered lagoon with engine for dairy becomes more cost efficient than the covered lagoon without engine for hogs. Indeed, the changes in the order of the most cost-effective technologies depend on the value of the other parameters (the capital costs, possible electricity savings...). Thus, the break-even price could become smaller for one type of lagoon compared to the other one. So, it appears that the results and

interpretations can change when the discount rate changes. For Vietnam, among studies done about carbon price and anaerobic digesters, it appears on the contrary that the discount rate is a little bit higher than 10%. In this country, the researchers and farmers may be more preoccupied by the payback period than the social and environmental aspect. Thus, a discount rate of 13% will be taken to see what could be the consequences in this country in terms of cost-effectiveness (Appendix XXIII). Here, the prices increase (again, this can be explained by the formula) but the way the technologies are classified is the same. Thus, the choice and the variation of this parameter will not have the same impact according to the country.

c. Sensitivity analyze of the break-even price P

Table 9 gives the break-even price (\$/tCO₂eq) of the covered lagoon with electricity production in USA pig farms if each parameter in its calculation changes with a given percentage. This table also presents the changes relative to the initial value found in this study for this technology, namely - 21.84\$/tCO₂eq. This table could thus show how robust the break-even price is to uncertainties in the parameters.

	-30%		-10%		+10%		+30%	
Change ER	-31.20	decrease 42.86%	-24.27	decrease 11.1%	-19.86	increase 9.1%	-16.80	increase 23%
Change CC	-28.50	decrease 30.5%	-24.06	decrease 10.15%	-19.62	increase 10%	-15.19	increase 30.5%
Change LC	-22.60	decrease 3.5%	-22.09	decrease 1.16%	-21.59	increase 1.16%	-21.08	increase 3.5%
Change R	-7.88	increase 63.9%	-17.19	increase 21.3%	-26.50	decrease 21.3%	-35.81	decrease 63.9%
Total change	-21.84	no change	-21.84	no change	-21.84	no change	-21.84	no change

Table 9: Effects of the change of each one of the parameters in the break-even price calculation

We can see that if the capital costs change by $\pm X\%$, then the break-even price will change by about $\pm X\%$ too, whereas the change in the labor costs leads to a lower change in the break-even price. Indeed, as explained before, in the USA, the capital costs have a bigger part in the total costs than the labor costs. If the revenues decrease for example, then the break-even price will increase to offset the costs. The results observed for the change in the emissions reduction can be surprising. Indeed, we could think that if the emission reduction decreases, then the break-even price should increase. But actually here, it will depend on the value of the other parameters. Indeed, the value of the revenue is higher than the value of the annualized capital costs (twice higher). Thus, for example if the emission reduction decreases by 30%, the break-even price could decrease too.

d. Distinction between small and large farms in the USA

AgSTAR (no date) explained that the profitable farms that could develop a digester are the one that have more than 500 cows or more than 2000 pigs. Up to now, this study did not take into account these thresholds (whose value will be discussed later). Here we will explain the results if we take them into account (only for the dairy farms because of the lack of information and data in the pig farms). Figure 27 represents the MAC curves if we consider only the little farms (less than 500 cows, 11.9% of the reported dairy farms with a digester) or only the large farms (more than 500 cows, 88.1%), while selecting the capital costs, the energy revenues and the production related to the largest farms or the smallest one:

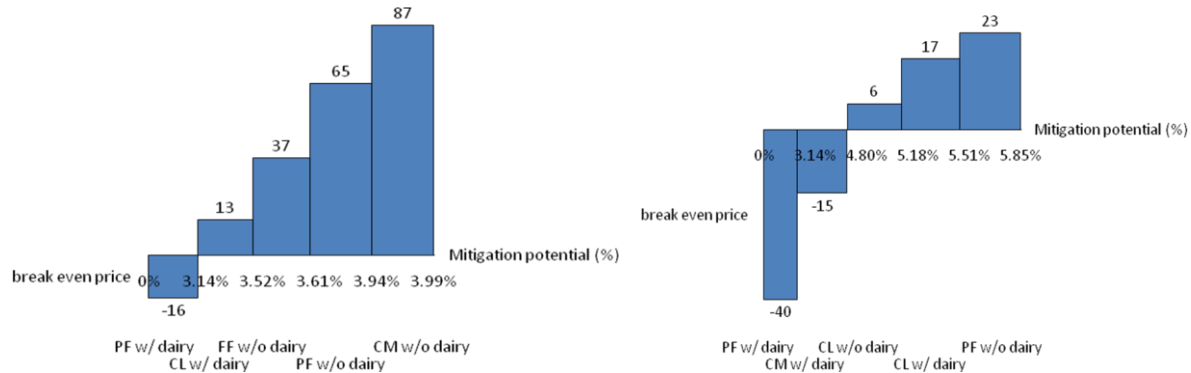

Figure 27: Cost-effectiveness of the digesters in the little (left) and large (right) dairy farms

Globally, we can find more cheap technologies within the large farms. For example, if we look at the digesters that have been found in both cases, the plug flow digester with and without an engine for electricity generation, we can see that the break-even price is lower in the large farms (economies of scale), so the cost for abating an additional ton of emission is lower. This is one of the reasons for which such technologies are more suitable in the large farms. Among the little farms, some could be research centers so they could receive helps from the state or from some programs. Other may produce biogas but if the electricity price from the grid exceeds the amount the local utility paid the farm, then the electricity could be used to power the farm and the digester can be used for odor reduction, selling the soil and compost, improve manure handling during the winter months.

Now if we compare to what happens in reality we can see that among the little farms that have a digester in 2010 (14 known digesters), 42.86% have a complete mix with an engine, 28.57% have a plug flow (3 farms with and 1 without engine), and 21.43% have a covered lagoon (2 farms with and 1 without an engine). Thus, here according to our results, the cheapest technology is not the most applied among the small farms. In the large farms (114 known digesters), 61% have a plug flow (63 farms with and 6 without an engine), 26.55% have a complete mix (29 farms with and 1 without an engine), and 10.62% have a covered lagoon (half of the farms have an engine, the other half do not). Here, on the contrary, the order of the most cost efficient technologies is the same than the one we found on the field and the share of each digester type here is consistent with the allocation made before (implied adoption rate in 2010). Thus, the little and large farms do not react the same way and their motivations to choose a digester type is not the same.

As explained before, this study, distinguishing the little and large farms, for pig farms is not possible because only 2 farms with less than 2000 animals and equipped with a digester are known among the pig farms that have a digester, and not enough information is available about these farms

to build other MAC curves. However, we can observe these 2 farms both have a plug flow, among the 5 farms that have between 2000 and 4999 head, 80% have a lagoon, among the 7 farms that have between 5000 and 9999 heads, 57% have a lagoon (the rest have a complete mix), and finally 83% of the largest farms (more than 10 000 heads, 6 farms) have a lagoon. Thus we can see that the smallest pig farms have a plug flow and the largest one have a lagoon²⁴.

e. Progressive adoption rate

Up to now, we did not pay attention to the adoption “rate”. Indeed, the implied adoption rate, namely the share of the digesters in 2010, has been taken into account, but we supposed the full adoption at this rate the first year (over the 20 years lifetime). However, in reality, this assumption is not possible. Indeed, for any carbon equivalent price, the adoption rate is likely to be progressive, increasing gradually over time as farmers learn from others about the benefits of adoption and participation in carbon markets. Thus, the MAC curves have been built again taking into account both 5% and 10% adoption rates each year. As explained above, the break-even price does not change if we consider the full adoption the first year or a progressive one, because this price is not linked to the quantity of farms that use the technology. However, the abatement potential will change. The methodology used to build these new curves is explained in Appendix XXIV. Figure 28 presents the results:

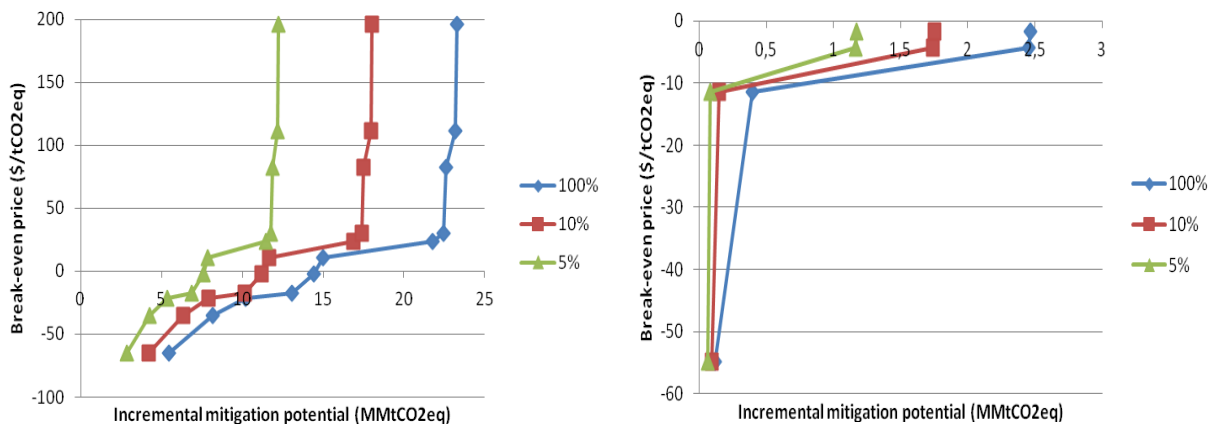

Figure 28: Effect of the application rate in the USA (left) and Vietnam (right)

Thus it appears that the full adoption assumption for the first year overestimate the abatement potential, for each technology and the incremental potential. The lowest rate we take, the lowest abatement potential we have. Indeed, an application rate of 5% each year leads to about twice less mitigation if we consider all the technologies together than a full adoption assumption the first year.

²⁴ Source: AgSTAR, <http://www.epa.gov/agstar/projects/index.html> visited on the 24/07/12

III. Discussion

A. Focusing on manure

Livestock manure is not actually the first kind of manure that raised some issues about climate change. Indeed, Wilkinson *et al.* in 2012 explained that according to their model and assumptions, dinosaur manure, and especially their methane emissions, could have played an important role in influencing the climate in the Mesozoic (from 250 to 65 million years ago).

As explained before, manure is an important source of GHG. Thus, focusing on manure in this study provides results that are relevant to a significant share of anthropogenic emissions. However, quite often, the farmers do not use only manure to feed the digester. Indeed, they can use plants, fruits, or a mix of different kind of manure (pig and dairy for example). So, even if the digesters are mainly fed with manure in this study, it is very difficult to know the exact share of manure in the digester. In Germany for example, in 2011, there were about 7000 digesters. All use manure to feed the digester but it appears that only 45% of the digester volume is excreta (animal and sometimes human). Moreover, the plug flow digesters in the US need a high solid content, so, the farmers can use other by-products with the dairy manure to obtain this solid content. In Vietnam, it is quite common that the farmers have pigs and poultry or pigs and cows. So the manure type that will feed the digester will not come from only one type of animal. But in Vietnam or developing countries much more than in developed countries, it is hard to have precise data on the farmers' practices. So the composition of the digester is a parameter that we did not take into account but that is quite important to be sure of the efficiency of the digesters fed with manure.

B. Suitability of the data found

○ Sources

US data mainly come from AgSTAR and some official report (US dairy for example) and the data found are quite precise (besides about the labor costs). However, in Vietnam, the data come from expert judgments and new documents from a recent project for pig farms. The suitability of the data found can be discussed. However, very few information exist in this area and the researchers who are working on this are not numerous. In this study, the same efficiency of the digesters to reduce the CH₄ has been used for each kind of digester. Indeed, not enough information enabled us to distinguish the different kind of digesters. However, some studies have been done about the characteristics of the Vietnamese digesters. From these studies, we can guess some differences in the efficiencies but no quantitative data could have been found from them. Nguyen *et al.* (2012) explain that the efficiency of the options to decrease the amount of CH₄ emitted depends on:

- The hydraulic retention time (HRT): the lower it is, the less efficient the treatment is. According to this study, the HRT of the KT1/2 is higher than the one for the plastic bag, which is higher than the one for the composite digester.
- The ratio manure/water: the standards are 1:1, 1:3. It is the case for the composite and the KT1/2 but not for the plastic bag.

- The gas pressure: if it is low, the gas cannot be used for something else than cooking. This pressure within a composite digester is higher than within a KT1/2 which is higher than within a plastic bag.

Moreover the plastic bag is not very robust, is sensitive to the sun, people, animals and objects, so the leakage risk is higher, the temperature is not constant so its efficiency will vary according to the climate or the season. Thus, according to these parameters, we can guess that the plastic bag is less efficient to reduce the CH₄ than the other digesters. However, it is not really possible to have figures on the difference of efficiency between the digester types. This is why the same one has been taken in this study. Finally, the figure found for the leakage (10%) comes from one single source. It is possible that other studies find another figure.

The data collected in the USA for the capital costs were quite precise for some technologies, but much less for those who are not used a lot. Indeed, the capital costs of 23 dairy farms have been used for the plug flow digester, but only 7 dairy farms have been taken into account for the complete mix digester. Indeed, no additional information has been found about the other dairy farms that have this kind of digester. Thus, we can wonder if these data are very representative of the reality. A cost estimate for a mean dairy farm for the lagoon and the complete mix has been done. The comparison between this cost estimate done for the complete mix (in New York and Pennsylvania) and the mean cost per head found in the study shows that this difference is not really important (the estimate gives a higher amount, but it depends on the possible grants the farm could obtain from the state or any program related to the installation). Finally very few information have been found for the lagoon, especially with a digester in the dairy farms. Thus the capital cost per head from the cost estimate done by RCM international has been used. The values used for the capital cost, labor costs, revenues, are “representative” of a mean farm according to the information available. The emission baselines are for the country. Thus, we assumed that the values taken for the costs and revenues can be valid for every farm in the whole country, which is obviously not true (distinguishing the farm with more criteria than their size is possible but require more time and data).

- o Assumptions

AgSTAR declared that the digesters are profitable in the farms that have at least 500 cows or 2000 pigs. RCM, a company that install a digester, would apparently not install, or at least would not advise to set up a digester, in the small farms.

Having a digester is profitable if the farmer can be paid back for his investment within the life time of the technology, namely 20 years. Thus the payback period should be 20 years maximum. So, the number of animals has been calculated so that the farmer will be refunded 20 years after the building of the digester. This quantity of animals will be the minimum number of animals requested in the farm to run the digester because the more animals the farmer have, the less time he will have to wait before being paid back. Indeed, if the revenue per head does not change, the cost per head decreases when the number of animals increases (economy of scale).

Some cost estimates for 500 and 1000 cows, and for 940 and 2000 pigs have been done by RCM international. Thanks to these studies for dairy and pigs, it is possible to find out how many animals will lead to a payback of 20 years with and without grants. The result of this test is presented in Appendix XXV with the excel extract of the calculations.

The results show that for a pig farm that would like to build a lagoon in North Carolina (first state for pig production and where many lagoons can be found), 1793 pigs will be requested to have a payback of 20 year with grants from USDA (25% of the total cost) and NRCS (\$760 for 1000 lbs of animal weight) and 2504 if the farmer receives no grants. Thus the assumption of 2000 pigs according to AgSTAR is feasible. For dairy farms, the study has been done for a complete mix digester in Pennsylvania (one of the first state for dairy production and where many complete mix digesters can be found). The results show that 583 animals are requested to have a payback of 20 years without grants from USDA or from CFA (clean energy program from Pennsylvania state especially), and that any kind of farm could be profitable if the farmer receives these grants. Thus, the assumption of 500 cows is feasible if we consider that the farmers could not have these helps from the state. However again, this remark does not mean that the little farms cannot have a digester. It just means that it is not advised. In reality, as explained before, we can find some little farms that have a digester, almost none in the pig farms but some in dairy farms.

C. Next steps

A couple of parameters have not been taken into account in this study because of the lack of data or time. For example, the transaction costs. Only a few studies exist about this and these costs could change within a country. But these are costs that could be taken into account in the model because they change between the situation where there was no digester and the situation where there was one.

Moreover, the fact that digested manure could be sold and used as a fertilizer has not been taken into account either because of the lack of time. Here however, studies, at least in the developed countries such as Europe or the USA, have been done about this. Thus, the benefits could be higher if we consider this revenue source. However, to have benefits from the digested manure sold or spread in the land, the N and P contents of the manure after the digestion have to be higher than before. Otherwise we could have opportunity costs.

In this study we just took into account the electric revenue to look at the effect of the electricity savings on the break-even price if the digesters have an engine or not. But the heat savings could have also been taken into account. Indeed, even the digesters that do not have an engine could use the biogas to heat the buildings for example, whereas the one that have an engine use the biogas for electricity and heat. Then, the farmer will save money from propane or natural gas. We said that the digester efficiency to convert the biogas in electricity is 25%. The rest could be used as heat. So the heat savings could actually be important if we consider a natural gas price of \$11.39/1000ft³ (\$1.122*10⁻⁵/Btu)²⁵. However, this savings can be lowered if we consider the efficiency of the digester to use the heat and to transport it to the buildings.

Finally, it could also be possible to do a dynamic analysis from this static one. Indeed, from a starting date of 2010, we could have a look on the trends up to 2030. However, if the trends in the emissions can be found, we need to find the relative trends in the animal number. This information has not been found, this is why the dynamic part could not have been done in this study. Moreover, the technologies can improve and the prices can decrease. Under those conditions, this static study could underestimate the abatement potential. This is also why, leading a dynamic study could be interesting.

²⁵ Source: http://www.eia.gov/dnav/ng/ng_pri_sum_dc_u_nus_a.htm (visited on the 16/08/12)

Conclusion

The objectives of this study were to express the potential of the anaerobic digesters in the USA and Vietnam to reduce the greenhouse gases and to estimate the net costs of these technologies, and to build the MAC curves, under a range of assumptions. This work was not easy, especially in Vietnam, because of the difficulty to find information about this technology in a developing country, but also in the USA because these options are still not well-adopted in this country. However, the results highlight nevertheless the existence of some cost-effective technologies in both countries, which have the potential to play an important role in the agricultural greenhouse gases mitigation and in the fight against climate change. In the USA, the plug flow digester with electricity production and the complete mix with electricity production appear to be quite cost-effective technologies in the dairy and pig farms respectively. Indeed, they both have a negative break-even price, which is also lowest than for the other options. Moreover, the model found that all these technologies could lead to a total abatement potential of 23.26 MMtCO₂eq, which represents 13.37% of the total non-CO₂ emissions from livestock or 52% of the manure CH₄ in 2010. In Vietnam, the VACVINA digester seems to be the most cost-effective technology in pig farms. The model also found that 2.47 MMtCO₂eq could have been reduced in 2010 thanks to these four technologies (under the assumptions used in this model), which represents 15% of the total non-CO₂ emissions from livestock or 51% of the manure CH₄ in 2010. Moreover, it shows the heterogeneity of the farms situation within each country, the different concerns of the farmers and the mass of parameters that actually have an impact on the choice of a farmer for the type of digester to install and on his willingness to install it. Indeed, sometimes, the cheapest technologies are not always the most applied and a homogeneous distribution of the technologies in the country or a geographic distribution of the options based on bio-physical parameters lead to different mitigation potentials compared to the observed share of the digesters in 2010. Distinguishing the small and large farms to take into account the farm size is also an important parameter to take into account. It appears that these technologies are mostly profitable in a developing country such as Vietnam and could also interest the developed countries that try to meet their commitments under the Kyoto Protocol. Thus, the policymakers have to deal with many factors while building new climate change policies for example about anaerobic digesters: economic one such as the price and the economic situation of the country or region, and bio-physical ones such as the climate effects or the location. Finally, this study also proved the need to have precise data and realistic assumptions. These latter are necessary while building a global model, this is why its applicability at a country or county scale can be discussed.

If manure is one of the main GHG sources in agriculture and livestock, enteric emissions are also very important. Moreover, as mentioned before, some measures on the animal diet could reduce enteric GHGs and manure GHGs. Thus, while this study has been done about a technology that can only reduce manure CH₄, doing a similar analysis about some measures that will have an effect on enteric GHG emissions could be also very useful for policymakers. Indeed, analyzing the effects of an option, whose aim is to decrease the enteric emissions, on the manure emissions could be an interesting study to reduce GHGs from both sources. And then, the comparison of the MAC curves could help to find the best mitigation options to decrease GHGs from livestock.

Bibliography

- ADEME (Agence de l'environnement et de la maîtrise de l'énergie), AILE (Association d'Initiatives locales pour l'Energie et l'environnement), Solagro, TRAME (2011).** La méthanisation a la ferme : guide pratique, pour les projets d'une puissance électrique inférieure à 500 kWe. ISBN: 978 - 235 -80 - 052 - 2 / Référence ADEME 7201, 20p.
- AgSTAR, United States Environmental Protection Agency (no date),** Market Opportunities for Biogas Recovery Systems: A Guide to Identifying Candidates for On-Farm and Centralized Systems. EPA-430-8-06-004, 34p.
- AgSTAR (2009).** Anaerobic digestion capital costs for dairy farms. 2p.
- BATES Judith.** Economic Evaluation of Sectoral Emission Reduction Objectives for Climate Change: Economic Evaluation of Emission Reductions of Nitrous Oxides and Methane in Agriculture in the EU, Bottom-up Analysis. Abingdon (UK): AEA Technology Environment, 2001, 90p.
- Baylis K., Paulson N.D. (2011).** Potential for carbon offsets from anaerobic digesters in livestock production. *Animal feed science and technology*, 166-167, 446-456, 11p.
- BEDDOES Jenifer, BRACMORT Kelsi S., BURNS Robert T., LAZARUS William F., HERBERT Noller H.** An analysis of energy production costs from anaerobic digestion systems on U.S. Livestock production facilities. USDA, Natural Resources Conservation Service (NRCS), 2007. 33p. Technical note No.1.
- Berg W., Model A. (2008).** Gypsum reduces methane emission during the storage of pig slurry. *Australian Journal of Experimental Agriculture*, 48, 96–98, 3p.
- BISHOP C., FREAR C., SHUMWAY R., CHEN S.** Economic evaluation of commercial dairy anaerobic digester. Pullman: Washington State University, Center for Sustaining Agriculture and Natural Resources, 2010. 17p. CSANR Research Report 2010 – 001. Available at this website <http://csanr.wsu.edu/publications/researchreports/CFF%20Report/CSANR2010-001.Ch04.pdf> visited on the 30/07/12.
- Bockel L., Touchemoulin O. (2011).** Draft the low carbon agricultural support project (LCASP) in Vietnam: Carbon balance appraisal with the Ex-Ante Carbon balance Tool. FAO, Rome, 26p.
- Chadwick D., Sommer S., Thorman R., Fanguero D., Cardenas L., Amon B., Misselbrook T. (2011).** Manure management: Implication for greenhouse gas emissions. *Animal feed science and technology*, 166-167, 514-531, 18p.
- Clemens J., Ahlgrimm H-J. (2001).** Greenhouse gases from animal husbandry: mitigation options. *Nutrient Cycling in Agroecosystems*, 60, 287–300, 14p.

- De Klein C.A.M, Eckard R.J.** (2008), Targeted technologies for nitrous oxide abatement from animal agriculture. *Australian Journal of Experimental Agriculture*, 48, 14–20, 7p.
- Dinuccio E., Balsari P., Berg W.** (2008). GHG emissions during the storage of rough pig slurry and the fractions obtained by mechanical separation. *Australian Journal of Experimental Agriculture*, 48, 93-95, 3p.
- Eastern Research Group Inc, PA consulting group, International institute for energy conservation** (2010). Resource Assessment Report for Livestock and Agro-Industrial Wastes Vietnam. The Methane to Markets Partnership, 2010. 63p. Available at this website: http://www.globalmethane.org/documents/ag_vietnam_res_assessment.pdf visited on the 31/07/12.
- Eghball B., Power J.F.** (1994). Beef cattle feedlot manure management. *Journal of soil and water conservation*, 49, 2, 113, 15p.
- Food and Agriculture Organization of the United Nations (FAO)** (2006). Livestock's Long Shadow: Environmental Issues and Options. FAO, Rome (Italy), 416p.
- Food and Agriculture Organization of the United Nations (FAO)** (2009), State of Food and Agriculture: Livestock in the Balance. Rome (Italy), 166p. Available at this website: <http://www.fao.org/docrep/012/i0680e/i0680e.pdf> visited on the 17/08/12
- General Statistics Office of Vietnam** (2007), Volume 3: Agriculture, forestry and fishery In: Results of the 2006 rural, agricultural and fishery census. Statistical publishing house, Hanoi (Vietnam), part 3, 98p.
Website: http://www.gso.gov.vn/default_en.aspx?tabid=515&idmid=5&ItemID=8058 visited on the 17/08/12.
- GFA Consulting Group GmbH a, Asian Development Bank** (2011). Supplementary documents: Biogas technology assessment. In: Strengthening Project Management and Developing Strategies and Options for Biogas Development Program Expansion Vietnam Mid-term report, Krause G. (GFA Consulting Group), Hamburg (Germany), 84p.
- GFA Consulting Group GmbH b, Asian Development Bank** (2011). Supplementary documents: Livestock sector detailed technical assessment. In: Strengthening Project Management and Developing Strategies and Options for Biogas Development Program Expansion Vietnam Mid-term report, Krause G. (GFA Consulting Group), Hamburg (Germany), 21p.
- GFA Consulting Group GmbH c, Asian Development Bank** (2011). Proposed Loan Socialist Republic of Vietnam: Strategies and Options for Biogas Development Program Expansion. In: Strengthening Project Management and Developing Strategies and Options for Biogas Development Program Expansion Vietnam Mid-term report, Krause G. (GFA Consulting Group), Hamburg (Germany), 131p.

- GFA Consulting Group GmbH, Asian Development Bank** (2012). Proposed Loan Socialist Republic of Vietnam: Low Carbon Agriculture Support Project Vietnam Draft final report, Krause G. (GFA Consulting Group), Hamburg (Germany), 202p. Project Number: 45406
- Golub A.A., Henderson B., Hertel T.W., Gerber P.J., Rose S.K., Sohngen B.** (2012). Global climate policy impacts on livestock, land use, livelihoods, and food security. PNAS, Herrero M., 6p.
- Gooch C.A., Pronto J.L.** (2009). Capitalizing on Energy Opportunities on New York Dairy Farms Participant Briefing Paper: Reference Document. In: Dairy Power New York Summit: Creating a Greener, Cleaner Future, Syracuse (USA), October 29-30 2009, 100p.
- Haeussermann A., Hartung, E., Gallmann, E., Jungbluth, T.** (2006). Influence of season, ventilation strategy, and slurry removal on methane emissions from pig houses. *Agriculture, Ecosystems and Environment*, 112, 115–121, 7p.
- HAI ANH Tran.** Evaluation study for household biogas plant models. Vietnam: Sustainable Energy Development Consultancy Joint Stock Company (SEDCC), 2010. 114p.
- Henderson B., Gerber P., Opio C.** (2011). Livestock and climate change, challenges and options. *CAB Reviews: Perspectives in Agriculture, Veterinary Science, Nutrition and Natural Resources*, 6, 116, 11p.
- Hishinuma T., Kurishima H., Yang C., Genchi Y.** (2008). Using a life cycle assessment method to determine the environmental impacts of manure utilisation: biogas plant and composting systems. *Australian Journal of Experimental Agriculture*, 48, 89-92, 4p.
- HRISTOV A. H., OH J., LEE C., MEINEN R., MONTES F., OTT T., FIRKINS J., ROTZ A., DELL C., ADESOGAN A., YANG W., TRICARICO J., KEBREAB E., WAGHORN G., DIJKSTRA J., OOSTING S.** Regionally appropriate and effective livestock non-CO₂ mitigation package. FAO, 2012. 120p.
- HURLEY Sean, AHERN James, WILLIAMS Douglas.** Clustering of Independent Dairy Operators for Generation of Bio-Renewable Energy: A Feasibility Analysis. San Louis Obispo (USA): California Polytechnic State University, California Institute for the Study of Specialty Crops, 2006. 89p.
- Huu Luu D., Potvin C., Kooijman van Dijk A., Geurts P.** (2011). Vietnam Biogas Assessment Research Project. 52p.
- Ihara I., Toyoda K., Watanabe T., Umetsu K.** (2008). Nitrogen and energy balances of a combined anaerobic digestion and electrochemical oxidation process for dairy manure management. *Australian Journal of Experimental Agriculture*, 48, 208-212, 5p.
- IPCCa (Intergovernmental Panel on Climate Change)**, (2001). Atmospheric Chemistry and Greenhouse Gases. In : Climate Change 2001 : The scientific basis, Contribution of Working Group I to the Third Assessment Report of the Intergovernmental Panel on Climate Change.

IPCC, Watson, R.T. and the Core Writing Team (eds.), Cambridge University Press, Cambridge (UK) and New York (USA). Available at this website:

http://www.grida.no/publications/other/ipcc_tar/ visited on the 29/07/12.

IPCCb (Intergovernmental Panel on Climate Change) (2001). Radiative forcing of climate change. In: Climate Change 2001 : The scientific basis, Contribution of Working Group I to the Third Assessment Report of the Intergovernmental Panel on Climate Change. IPCC, Watson, R.T. and the Core Writing Team (eds.), Cambridge University Press, Cambridge (UK) and New York (USA). Available at this website: http://www.grida.no/publications/other/ipcc_tar/ visited on the 03/08/12.

IPCC (Intergovernmental Panel on Climate Change), Smith P, Martino D, Cai Z, Gwary D, Janzen H, Kumar P, McCarl B., Ogle S., O'Mara F., Rice C., Scholes B., Sirotenko O. (2007). *Chapter 8: Agriculture*. In: Climate Change 2007: Mitigation of climate change. Contribution of Working Group III to the Fourth Assessment Report of the Intergovernmental Panel on Climate Change. Metz B., Davidson O.R., Bosch P.R., Dave R., Meyer L.A. (eds), Cambridge University Press, Cambridge (UK) and New York (USA). Available at this website: http://www.ipcc.ch/publications_and_data/ar4/wg3/en/ch8.html visited on the 27/07/12.

Jackson R.S. (2006), Economic implications of anaerobic digesters on dairy farms in Texas. Master of science, Major Subject: Agricultural Economics, Texas A&M University, 142p.

Jørgensen H., Theil P.K. and Bach Knudsen K.E. (2011). Enteric methane emission from pigs. In: Planet Earth 2011 – Global Warming Challenges and Opportunities for Policy and Practice. Dr. Carayannis E.G. (editor), Rijeka (Croatia), 605-622, 18p.

Kaku K., Ikeguchi A. (2008). Approximation of baselines and greenhouse gas reduction scenarios for a small-scale Clean Development Mechanism on agriculture and livestock in ASEAN. *Australian Journal of Experimental Agriculture*, 48, 248-250, 3p.

KEY N., SNEERINGER S., Carbon prices and the adoption of methane digesters on dairy and hog farms. Washington (USA): U.S. Department of Agriculture (USDA), Economic Research Service, 2011. 8p. EB-16.

Larney F.J, Buckley K., Xiyang H., McCaughey W. P. (2006). Fresh, Stockpiled, and Composted Beef Cattle Feedlot Manure: Nutrient Levels and Mass Balance Estimates in Alberta and Manitoba. *Journal of Environmental Quality*, 35, 5, 1844-1854, 11p.

LAZARUS, William F., GOODKIND Andrew, GALLAGHER Paul, CONWAY Roger. Carbon Prices Required to Make Digesters Profitable on U.S. Dairy Farms of Different Sizes. St Paul (USA): University of Minnesota, 2011. 48p.

Levasseur P. (2006)., L'expérience allemande de la méthanisation à la ferme : transposition au contexte français. Techniporc, Vol. 29, N°4, 13-20, 8p.

Levasseur P., Marcon M., Massabie P. (2007). Méthanisation à la ferme, levier de rentabilité en élevage porcin. *TechniPorc, la revue technique de l'IFIP*, Vol. 30, N°5, 17-22, 6p.

- Liang J.B., Suzuki S., Kawamura A., Habasaki A., Kato T.** (2008). Opportunities and challenges of converting biogas from pig farms into renewable energy in developing countries in Asia – a Malaysian experience. *Australian Journal of Experimental Agriculture*, 48, 54–59, 6p.
- Massé D.I., Talbot G., Gilbert Y.** (2011). On farm biogas production: A method to reduce GHG emissions and develop more sustainable livestock operations. *Animal Feed Science and Technology*, 166-167, 436-445, 10p.
- McGinn S.M., Flesch T.K., Crenna B.P., Beauchemin K.A., Croates T.** (2007). Quantifying ammonia emissions from a cattle feedlot using a dispersion model. *Journal of Environmental Quality*, 36, 6, p. 1585, 6p.
- McKinsey & Company**, Pathways to a Low-Carbon Economy: Version 2 of the Global Greenhouse Gas Abatement Cost Curve. 2009. 192p.
- Minchoff CJ M.** (2006). Economic Feasibility Study for a Centralized Digestion System. A Master of Engineering Project, Faculty of the Graduate School of Cornell University, Ithaca, 114p.
- Misselbrook T. H., Smith K. A., Johnson R. A., Pain B. F.** (2002). Slurry Application Techniques to reduce Ammonia Emissions: Results of some UK Field-scale Experiments. *Biosystems Engineering*, 81 (3), 313–321, 9p.
- Monteny G.J, Bannink A., Chadwick D.** (2006), Greenhouse gas abatement strategies for animal husbandry. *Agriculture, Ecosystems and Environment*, 112, 163–170, 8p.
- Monteny G.J, Groenestein C.M., Hilhorst M.A.** (2001). Interactions and coupling between emissions of methane and nitrous oxide from animal husbandry. *Nutrient Cycling in Agroecosystems*, 60, 123–132, 10p.
- MORAN D., MACLEOD M., WALL E., EORY V., PAJOT G., MATTHWES R., MCVITTIE A., BARNES A., REES B., MOXEY A., WILLIAMS A., SMITH P.** UK Marginal Abatement Cost Curves for the Agriculture and Land Use, Land-Use Change and Forestry Sectors out to 2022, with Qualitative Analysis of Options to 2050. Edinburgh (UK): SAC Commercial Ltd, The Committee on Climate Change, 2008. 168p. RMP4950.
- Mueller S.** (2006). Manure’s allure: Variation of the financial, environmental, and economic benefits from combined heat and power systems integrated with anaerobic digesters at hog farms across geographic and economic regions. *Renewable Energy*, 32, 248–256, 9p.
- NATIONAL RESEARCH COUNCIL.** The scientific basis for estimating air emissions from animal feeding operation. Washington DC (USA): National research council, 2002. 69p.
- NGUYEN QUANG DUNG.** Biogas user survey 2010-2011, Biogas development program for livestock sector in Vietnam 2007-2012. Hanoi (Vietnam): Vietnam Livestock Department-MARD, Netherland development organization-SNV, 2011. 50p.

NGUYEN QUOC CHINH. Dairy Cattle Development: Environmental Consequences and Pollution Control Options in Hanoi Province, North Vietnam. Hanoi (Vietnam): The Faculty of Economics & Rural Development Hanoi Agricultural University, Economy and Environment Program for Southeast Asia (publisher), 2005. 42p. No. 2005-RR6. Available at this website: <http://idl-bnc.idrc.ca/dspace/bitstream/10625/46079/1/132568.pdf> visited on the 31/07/12.

Nguyen V.C.N., Phan T.H., Vo H.N. (2012). Review on the most popular anaerobic digester models in the Mekong Delta. *Journal of Vietnamese Environment*, Vol. 2, No. 1, pp. 8-19. Available at this address: <http://www.openaccess.tu-dresden.de/ojs/index.php/jve/article/view/24/14> visited on the 31/07/12).

OCHIENG Francis Xavier. Survey of Plastic Tube Digesters in Kenya, A field assessment survey of the Performance of Plastic tube digestors in Kenya, Nairobi (Kenya): Deutsche Gesellschaft für Technische Zusammenarbeit (GTZ), 2010. 49p. Consultancy Reference Number: INT/EK/04/2010/GTZ

Oenema O., Wrage N., Velthof G.L., van Groenigen J. W., Dolfing J., Kuikman P.J. (2005). Trends in global nitrous oxide emissions from animal production systems. *Nutrient Cycling in Agroecosystems*, 72, 51–65, 15p.

PAUSTIAN Keith, BABCOCK Bruce, HATFIELD Jerry, LAL Rattan, MCCARL Bruce, MCLAUGHLIN Sandy, POST Wilfred M., MOSIER Arvin, RICE Charles, ROBERTSON G. Philip, ROSENBERG Norman J., ROSENZWEIG Cynthia, SCHLESINGER William H., ZILBERMAN David. Agricultural Mitigation of Greenhouse Gases: Science and Policy Options, Council on Agricultural Science and Technology, 2004. Page 120. Report R141 2004.

PORK CHECKOFF. Quick facts. Des Moines (USA): Pork Checkoff, 2012. 122p. #09133-04/12. Available at this website : <http://www.pork.org/Resources/95/QuickFacts.aspx> visited on the 31/07/12.

Powell J.M., Misselbrook T.H., Casler M.D. (2008). Season and bedding impacts on ammonia emissions from tie-stall dairy barns. *Journal of Environmental Quality*, 37, 7–15, 9p.

Rigolot C., Espagnol S. (2010). Effluents d'élevage et émissions de gaz à effet de serre. In Rencontre INRA Élevages demain pour des systèmes de production animale durable, Parc des expositions de Paris Porte de Versailles, 1^{er} mars 2010, 1p.

Rochette P., Angers D. A., Chantigny M., Gagnon B., Bertrand N. (2008). N₂O fluxes in soils of contrasting textures fertilized with liquid and solid dairy cattle manures. *Canadian Journal of Soil Science*, 88, 175 -187, 13p.

Rosegrant M.W., Fernandez M., Sinha A. (2008). Global Chapter 5 Looking into the future for agriculture and AKST (Agriculture Knowledge Science and Technology). In: International Assessment of Agricultural Science and Technology for Development (IAASTD) Global Report.

71p. (available at this address: <http://www.agassessment-watch.org/background.htm> visited on the 29/07/12)

Schils R. L. M., Verhagen A., Aarts H. F. M., Kuikman P. J., Sebek L. B. J. (2006). Effect of improved nitrogen management on greenhouse gas emissions from intensive dairy systems in the Netherlands. *Global Change Biology*, 12, 382–391, 10p.

Thorman R.E., Chadwick D.R., Boyles L.O., Matthews R., Sagoo E., Harrison R. (2006). Nitrous oxide emissions during storage of broiler litter and following application to arable land, *International Congress Series* 1293, 355– 358, 4p.

UNITED STATES ENERGY INFORMATION AGENCY (USEIA). State Electricity Profiles 2006. Washington: USEIA, 2007. 266p. DOE/EIA-0348(01)/2.

United States Environmental Protection Agency (USEPA) office of air and radiation (2004), Chapter 4 Technical and feasibility assessment. In: A Manual For Developing Biogas Systems at Commercial Farms in the United States, AgSTAR Handbook. Roos K.F., Martin J.B., Jr., and Moser M.A. (editors), EPA-430-B-97-015, 12p.

UNITED STATES ENVIRONMENTAL PROTECTION AGENCY (USEPA) a, office of atmospheric programs. Global Mitigation of non-CO2 Greenhouse gases. Washington DC (USA): USEPA, 2006. 438p. EPA 430-R-06-005

UNITED STATES ENVIRONMENTAL PROTECTION AGENCY (USEPA) b, office of atmospheric programs, Climate change division. Global anthropogenic non-CO2 greenhouse gas emissions: 1990-2020. Washington DC (USA): USEPA, 2006. 274p. EPA-430-R-06-003

UNITED STATES ENVIRONMENTAL PROTECTION AGENCY (USEPA). Inventory of US Greenhouse gas emissions and sinks: 1990-2010. Washington DC (USA): USEPA, 2012. 481p. EPA 430-R-12-001

UNITED STATES ENVIRONMENTAL PROTECTION AGENCY (USEPA). Draft: Global Anthropogenic Non-CO2 Greenhouse Gas Emissions: 1990 – 2030. Washington DC (USA): USEPA, 2011. 182p. EPA 430-D-11-003

United States Environmental Protection Agency (USEPA) office of air and radiation (1999). Livestock manure management. In: U.S. Methane Emissions 1990 – 2020: Inventories, Projections, and Opportunities for Reductions. USEPA, Washington (USA), 5_1-5_17, 26p.

Van der Meer H.G. (2008). Optimising manure management for GHG outcomes. *Australian Journal of Experimental Agriculture*, 48, 38–45, 8p.

Wilkinson D.M., Nisbet E.G., Ruxton G.D. (2012). Could methane produced by sauropod dinosaurs have helped drive Mesozoic climate warmth? *Current Biology*, Vol 22, No 9, 2p.

Werner U., Stöhr U., Hees N. (1989). Biogas plants in animal husbandry. Deutsches Zentrum für Entwicklungstechnologien (GATE), Division of the Deutsche Gesellschaft für Technische Zusammenarbeit (GTZ), 134p.

Websites

United Nation Economic Commission for Europe (UNECE) (no date). Protocol to Abate Acidification, Eutrophication and Ground-level Ozone.
http://www.unece.org/env/lrtap/multi_h1.html (visited on the 29/07/12)

United Nations Framework Convention on Climate Change (UNFCCC a) (no date). Kyoto Protocol.
http://unfccc.int/kyoto_protocol/items/3145.php (visited on the 03/08/12)

United Nations Framework Convention on Climate Change (UNFCCC b) (no date). About CDM.
<http://cdm.unfccc.int/about/index.html> (visited on the 29/07/12)

Appendix I: GHGs origins

Methane (CH ₄)	Nitrous oxide (N ₂ O)
ENERGY <ul style="list-style-type: none"> • Coal Mining Activities • Natural Gas and Oil Systems • Stationary and Mobile Combustion • Biomass Combustion 	ENERGY <ul style="list-style-type: none"> • Biomass Combustion • Stationary and Mobile Combustion
INDUSTRIAL <ul style="list-style-type: none"> • Chemical Production • Iron and Steel Production • Metal Production • Mineral Products • Petrochemical Production • Silicon Carbide Production 	INDUSTRIAL <ul style="list-style-type: none"> • Adipic Acid and Nitric Acid Production • Metal Production • Miscellaneous Industrial Processes
AGRICULTURE <ul style="list-style-type: none"> • Manure Management • Enteric Fermentation • Rice Cultivation • Agricultural Soils • Field Burning of Agricultural Residues • Prescribed Burning of Savannas 	AGRICULTURE <ul style="list-style-type: none"> • Manure Management • Agricultural Soils • Field Burning of Agricultural Residues • Prescribed Burning of Savannas
WASTE <ul style="list-style-type: none"> • Landfilling of Solid Waste • Wastewater • Solvent and Other Product Use • Waste Combustion 	WASTE <ul style="list-style-type: none"> • Human Sewage • Fugitives from Solid Fuels • Fugitives from Natural Gas and Oil Systems • Solvent and Other Product Use • Waste Combustion

Source: Christa Clapp, U.S. EPA (2007), *Climate Change: Tackling Non-CO₂ Greenhouse Gases*

Appendix II: GHGs emissions calculation

A study has been done by McGinn *et al.* in 2006 in a feedlot with a capacity of 22 500 cattles in Canada. The aim of this study is to quantify the NH₃ emissions with the Lagrangian stochastic inverse-dispersion technique (micrometeorological method). An atmospheric dispersion model has been used to find the source of an emission. A 3.4m tour has been built in the middle of the farm to measure the NH₃ concentration (with a laser) and the air speed (with an anemometer). A datalogger could determine the wind and heat flux every 15 min. Thus the laser calculates the NH₃ concentration and gives a result every 15 min. Some periods were ignored (too low wind, too much or not enough stable atmosphere, too high values that could be errors). So during the study period, 1307 15-min intervals have been collected after the data were filtered. And the average NH₃ concentration can be determined. Average emissions have also been estimated and this value can be compared to the other studies done in other US states like Texas (the value found is higher than the one found in Texas during summer). The difference between the studies can be explained by the different weather conditions. Moreover, for this study, a high coefficient of determination for heat flux but a low one for the wind has been found. The rain could also have an effect on NH₃ concentration but it's less obvious (could decrease NH₃ emissions). Finally in this farm, 63% of the feed N is lost. The technique used in this study seems efficient to quantify the N lost as NH₃ but it could be interesting to measure the NH₃ emissions from several sources to have national data. [McGinn *et al.*, 2007]

Another study made by EPA explains the calculation of the CH₄ emissions. The quantity and type of manure produced, the system for the management and the climate are the information required. The sum of the emissions at the state level according to the animal type and the management system leads to the national CH₄ emissions. So, the total amount of CH₄ produced in the USA depends on the total manure produced by animal type j in state i. For this manure, only the percentage that has been managed by system k (always for the animal type j in a state i, MF (ijk)) is taken into account. Then, for this manure in this system in this state for this type of animal, only the percentage of manure that is volatile solid (VS (ij)) is conserved, and then find the maximum methane potential of manure in this percent of volatile solids for a type of animal (Bo (j), found by laboratory researches). Finally, because all the manure don't convert into methane, we use the CH₄ conversion factor for the management k in the state i (MCF (ik)). The formula is:

$$CH_4 = \sum_i \sum_j \sum_k \text{manure (ij)} * MF (ijk) * VS (ij) * Bo (j) * MCF$$

This study concludes that manure production in 2020 could be 7% higher than in 1990 and 20 % more manure would be managed in liquid. So in 2020, CH₄ production in USA will be 8% higher than in 2000. The uncertainty about this study come from the estimates of the amount of manure managed by each type of manure system and of the CH₄ conversion factors for each manure system (not enough data for farm-size distribution), the amount of CH₄ produced which varies a lot between farms, forecasts of future dairy and meat consumption and productivity because of possible changes in the global market that will lead to a different demand for livestock exports. [USEPA, 1999]

Appendix III: Annex B of the Kyoto Protocol

Australia	UE-15	Lithuania	Russian Federation
Bulgaria	Hungary	Monaco	Slovakia
Canada	Iceland	New Zealand	Slovenia
Croatia	Japan	Norway	Switzerland
Czech Republic	Latvia	Poland	US
Estonia	Liechtenstein	Romania	Ukraine

Source: http://unfccc.int/kyoto_protocol/items/3145.php

Appendix IV: Comparison of the GHGs mitigation potential between 3 options in Thailand over time

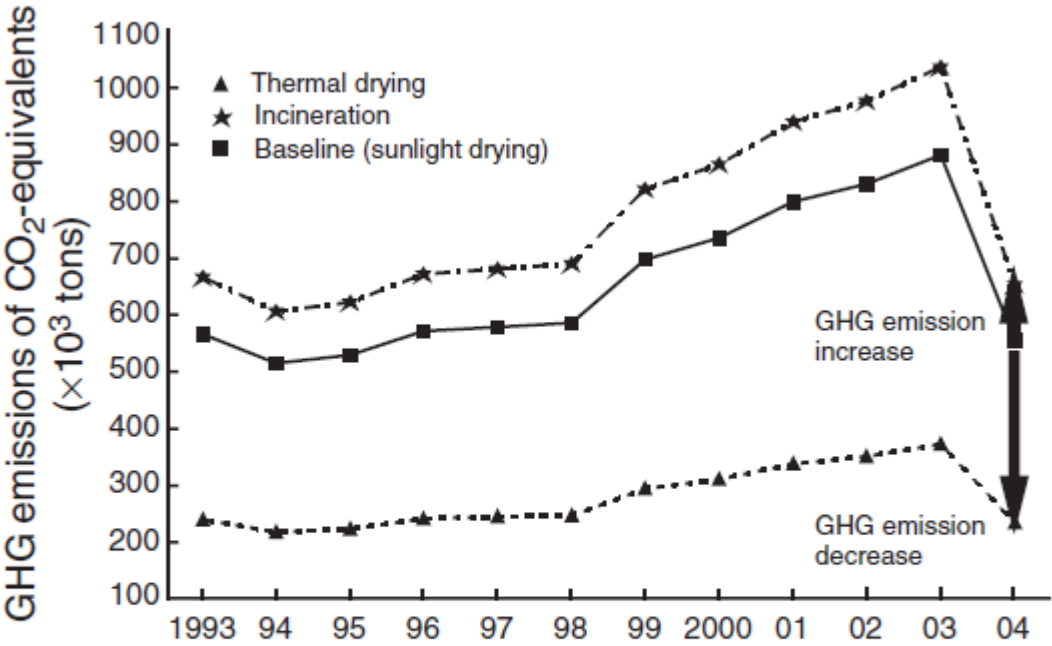
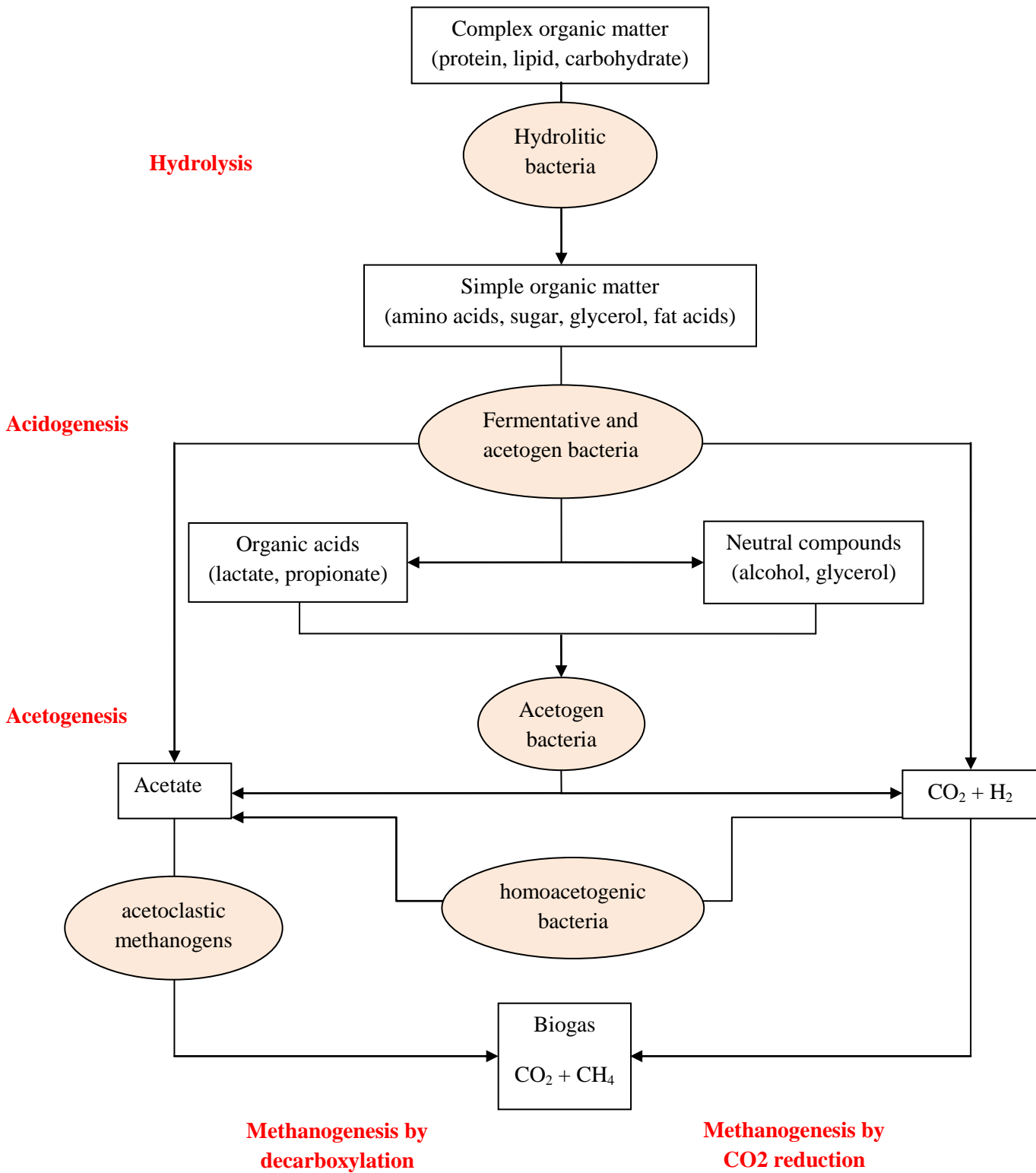

Fig. 3. GHG emissions of CO₂-equivalents from broiler and swine production in Thailand in 1993–2004 in accordance with three different methods of treating manure: (i) incineration, (ii) drying without energy input (using sunlight), and (iii) drying with energy input (using thermal energy).

Source: Kaku *et al.* 2008

Appendix V: Anaerobic digestion mechanism



Source: <http://methanisation.info/etapes.html> and Massé *et al.* (2011)

Appendix VI: Components of an anaerobic digestion system

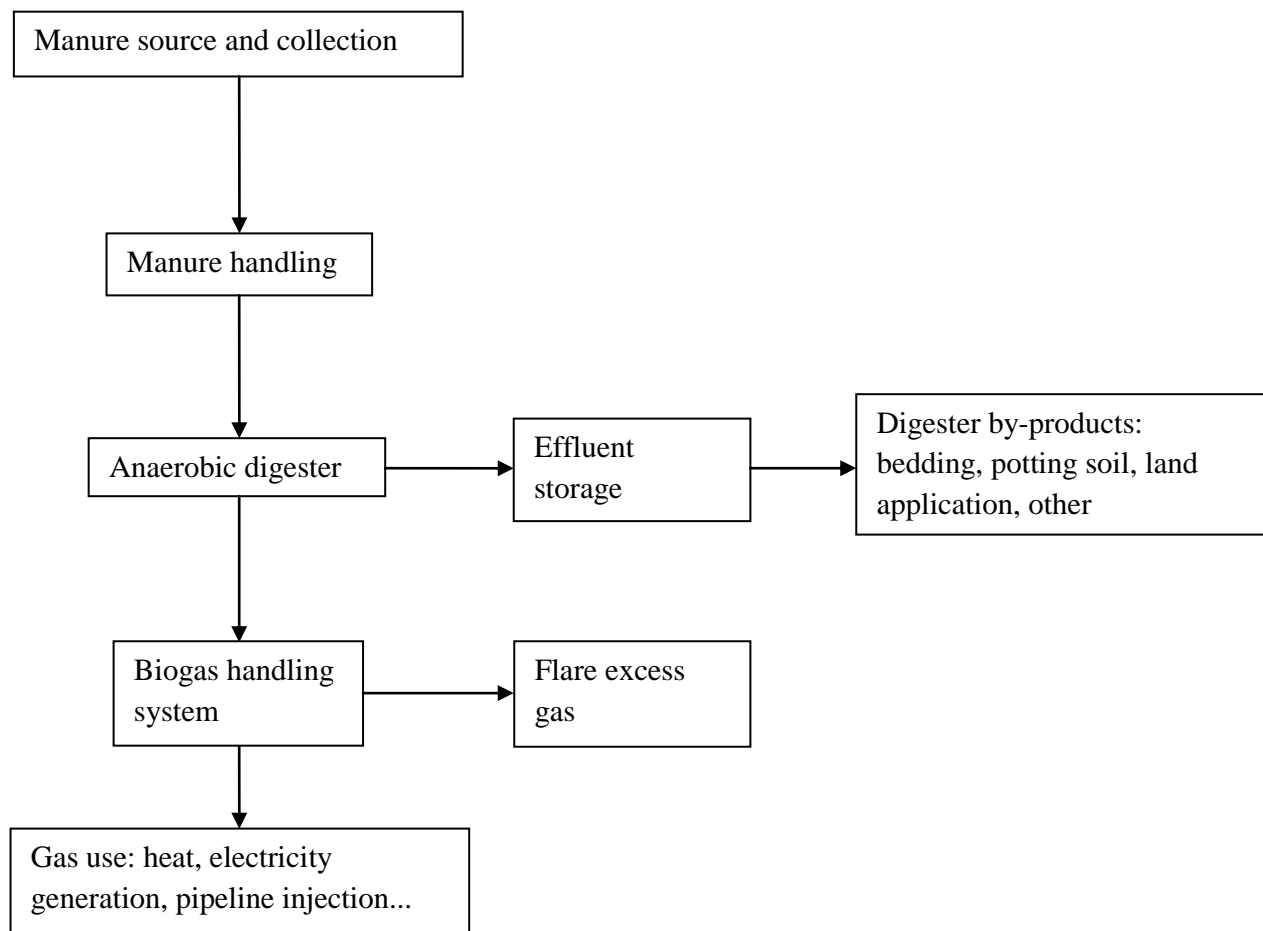

Source: AgSTAR : <http://www.epa.gov/agstar/anaerobic/ad101/index.html>

Appendix VII: AgSTAR

AgSTAR is a program created in 1994 to reduce CH₄ emissions from livestock, especially with the use of anaerobic digestion, and depends on the USEPA, the US Department of Agriculture and the US Department of Energy. AgSTAR provides many information and tools to help producers to evaluate and implement these systems, including:

- Conducting farm digester extension events and conferences
- Providing “How-To” project development tools and industry listings
- Conducting performance characterizations for digesters and conventional waste management systems
- Providing farm recognition for voluntary environmental initiatives
- Collaborating with federal and state renewable energy, agricultural, and environmental programs

AgSTAR helps farmers to determine if their facility can build a biogas recovery system and find the best technology for a site (creation of tools like the AgSTAR Handbook and FarmWare, which is software for a pre-feasibility assessment of anaerobic digestion). This is a project development. This program can also give information about strategies like low-interest loans, grants, and tax incentives to help farmers interested in anaerobic digestion technology to overcome financial barriers to project development. Moreover, AgSTAR provides contacts in industry field (project developers, energy services, equipment manufacturers and distributors, etc) and market opportunities studies.

191 systems exist in the United States, whose 175 produce electrical or thermal energy, which leads to important environmental and energy benefits (625 000 MWh generated per year). This increase in the number of digesters is due to financial incentives. For example, the USDA Rural Development through the Farm Bill gives grants and loans, which is important to partially fund installations of livestock waste digestion technologies. These anaerobic digesters can reduce GHGs emissions with the capture and burning of CH₄ (thus, it doesn't escape into the atmosphere) from the waste management system and while avoiding the emissions of GHGs (CO₂, CH₄, and N₂O) and other pollutants from the use of fossil fuels that otherwise would be used to generate energy.

AgSTAR works with state agencies, agricultural extension offices, universities, and other non-governmental organizations to promote the planning, deployment, and long-term success of anaerobic digester projects. The members of this partnership in the US receive technical, marketing, and networking assistance in return for their commitment to identify and overcome barriers for anaerobic digester projects, share information, and provide education to farms in their area.

This program also works with the Global Methane Initiative which reassembles 30 countries and the European Commission for the CH₄ capture and use in landfills, agriculture, underground coal mines, and oil and natural gas systems. This partnership works especially on the biogas project development in agricultural sector in the world.

Source: <http://www.epa.gov/agstar/>

Appendix VIII: Results of the cost study

Farm Size		100 sows					500 sows				
Swine manure	% total input	100	75	50	75	50	100	75	50	75	50
Corn silage		0	25	50			0	25	50		
Vegetable waste					20	40				20	40
Fat					5	10				5	10
Economic Aspects	Units										
Energy promoted W/O ⁽¹⁾	%	-	46	46	44	46	>100	54	50	52	49
Price W/O	Cent/kWh	-	11,5	11,5	11,3	11,5	-	12,1	11,6	11,9	11,3
Energy promoted W ⁽²⁾	%	-	53	49	49	48	-	57	52	54	50
Price W	Cent/kWh	-	12,1	11,7	11,8	11,7	-	12,4	11,7	12,1	11,3
Investment promotion heat (total)	k€	-	46,9				-	56,3			
Yearly energy spare	k€/year	-	7				-	18,6			
Investment without heat promotion	k€	-	246	394	257	550	-	868	1647	965	2187
Investment with heat promotion	k€	-	293	441	304	597	-	924	1703	1021	2243
Sum of the product W ⁽²⁾	k€/year	-	57	96	47	133	-	215	511	272	665
Sum of the product W/O ⁽¹⁾	k€/year	-	30	87	38	124	-	192	488	249	642
Operational costs	k€/year	-	34	85	19	43	-	154	417	82	201
IRT⁽³⁾											
Without heat promotion	Number of year			190	13	7		23	23	6	5
With heat promotion			62	128	11	7		15	18	5	5

⁽¹⁾: without thermal energy promotion other than for the digester

⁽²⁾: with heat promotion (house, animal building...)

⁽³⁾: total investment/(sum of the yearly product – sum of the yearly operational costs)

■ : above 12 years ■ : between 6 and 12 years ■ : below 6 years

Source: Levasseur *et al.* 2007

Appendix IX: MAC curves examples

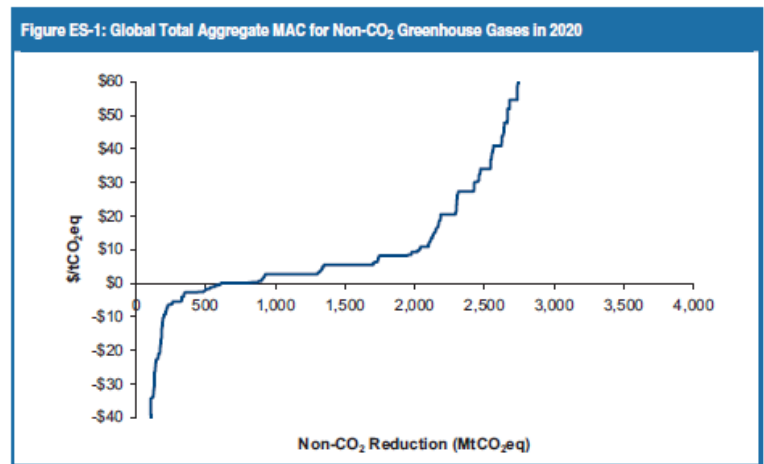
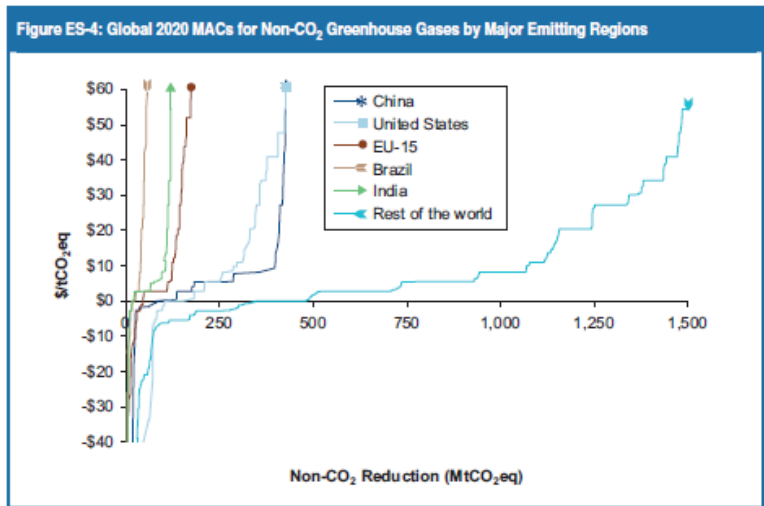
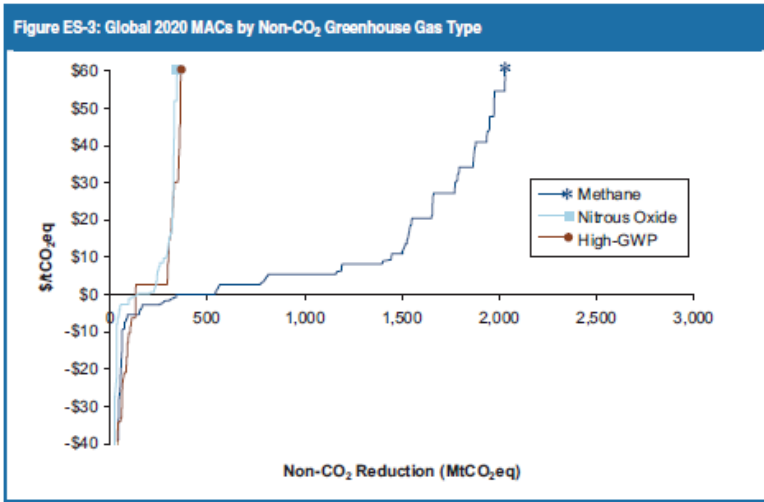

Source: USEPA a 2006

Appendix X: Annuity factor and break-even price

Without tax, with P = break-even price:

$$PV = R * \frac{1 - \left(\frac{1}{(1 + DR)^T}\right)}{DR} + P * ER * \frac{1 - \left(\frac{1}{(1 + DR)^T}\right)}{DR} - LC * \frac{1 - \left(\frac{1}{(1 + DR)^T}\right)}{DR} - CC = 0$$

$$\longleftrightarrow R + P * ER - LC - \frac{CC}{\frac{1 - \left(\frac{1}{(1 + DR)^T}\right)}{DR}} = 0$$

$$\longleftrightarrow P = \frac{CC}{ER * S} + \frac{LC}{ER} - \frac{R}{ER}$$

$$\longleftrightarrow \left[P = \frac{CC}{\frac{ER}{T} * S} + \frac{LC/T}{ER/T} - \frac{R/T}{ER/T} \right]$$

With a tax rate (TR):

$$PV = R * (1 - TR) * S + P * ER * (1 - TR) * S + \underbrace{\frac{CC * TR}{T} * S}_{\text{Tax break}} - LC * (1 - TR) * S - CC = 0$$

$$\longleftrightarrow R + P * ER + \frac{CC * TR}{T * (1 - TR)} - LC - \frac{CC}{(1 - TR) * S} = 0$$

$$\longleftrightarrow P = \frac{CC}{ER * (1 - TR) * S} + \frac{LC}{ER} - \frac{R}{ER} - \frac{CC * TR}{T * (1 - TR) * ER}$$

Appendix XI: Description of the Vietnamese digesters

○ KT1-KT2

They are small biogas plants, made of concrete and bricks that can be found in Vietnam [Bockel *et al.*, 2011]. The KT2 model is developed within the project “Vietnam Biogas Program for the Animal Husbandry Sector”, presided by the Department of Livestock Production - Vietnam’s Ministry of Agriculture and Rural Development in cooperation to the Netherlands Development Organization (SNV). It appeared in the country in 2003 [Nguyen *et al.*, 2012].

KT1 and KT2 are applied for low and high level water table respectively. The models have 6 main parts: mixing tank, digester (KT1: $V_d=8\text{m}^3$, $V_g=1.4\text{m}^3$, KT2: $V_d=6\text{m}^3$, $V_g=2.4\text{m}^3$), compensation tank, inlet, outlet and gas pipe. These digesters look like a dome, whereas the mixing tank has a rectangle shape. The compensation tank can have a dome-shape or a rectangle shape. All three tanks are connected together by inlet and outlet pipes. These digesters are very common. Their advantages are: the materials are easily available in Vietnam, the digesters have a long lifetime (because of the good materials quality), they are underground so some space is available for an animal shed, these technologies are easy to use, there could be quality controls, and they are gas and water tight (no odor, good bio-slurry). But they also have some disadvantages: they need a lot of space, the masons need to be trained, the damages are difficult to detect and to repair, and the KT1 can’t be build on a week or high water level soil. [Hai Anh, 2010]. A 2, 3, 4, 5, 6, 8, 10 m^3 digester need 50, 75, 100, 125, 150, 200, 250 kg of manure per day respectively. The hydraulic retention time is 30-40 days and the gas pressure is quite high²⁶. [Nguyen *et al.*, 2012]

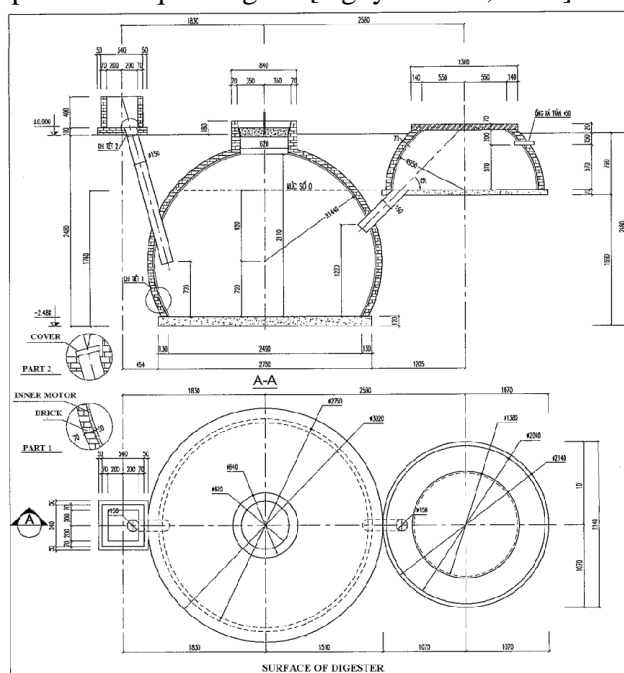

Source: Hai Anh (2010)

²⁶ The lower the hydraulic retention time is, the lower the treatment efficiency is. If the gas pressure is low, the gas can't be used in another aim than cooking (lighting for example)

○ Composite

This technology is originated from China and has been introduced in Vietnam in 2008.

Composite material made of synthetic fiberglass, carton fiber glass and polyester. The composite materials have to be imported outside of Vietnam [Bockel *et al.*, 2011].

It has 5 parts:

- Digester, $V_d = 7 \text{ m}^3$
- Gas storage, $V_g = 1.5 \text{ m}^3$
- Gas pipe
- Inlet for feeding material (with the dimension of 800mm)
- Overflow outlet (with the dimension of 900mm)

The tanks are designed in one block and buried underground.

This model is quite popular in the North and Central of Vietnam. Its advantages are: gas and water tight, a high durability, a quite long lifetime (20 years), simple and fast construction and installation (doesn't need to train the masons), it is supposed to be odorless, is suitable to weak soil and high water table soil and the operation and maintenance works are easy to do. It can be installed in areas where underground water table is high. The disadvantages of this model are: the high cost (supposed to be the most expensive digester besides the large scale one), the difficult transport, no quality control, the technical problem with the gas pipe sometimes, the leakage through the pipes and the fact that not a lot of sizes are available for this digester. The hydraulic retention time is 10 days. [Hai Anh 2010, Nguyen *et al.* 2012]

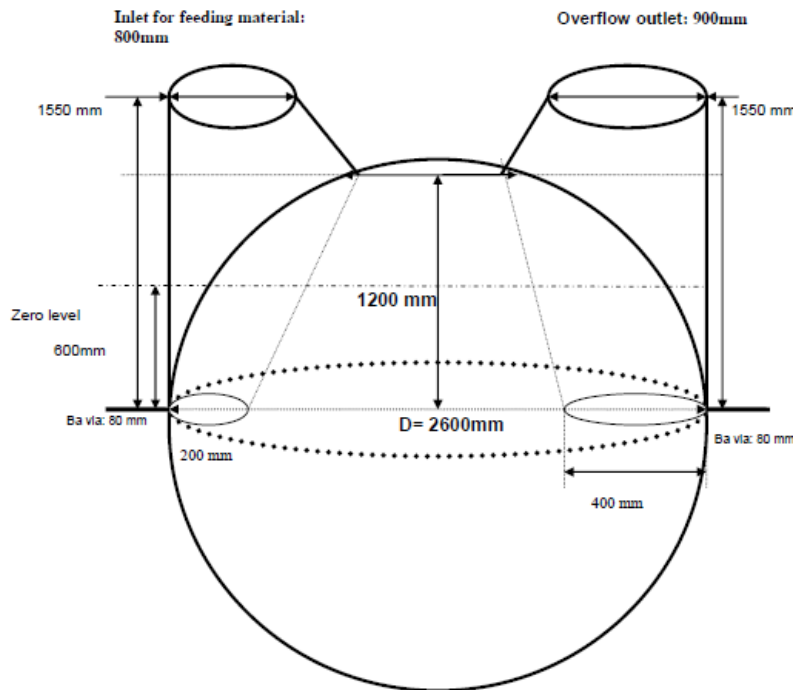

Source: Nguyen *et al.* 2012

○ Polyethylene bag

It was firstly introduced in Taiwan and then, some modifications have been done in this type of digester to be implemented in Ethiopia and in Columbia. It has been introduced in Vietnam in 1992 and is mainly use for cooking. The hydraulic retention time is 17 days. [Nguyen *et al.*, 2012]

This digester is made in PVC which is sold in many localities. This model has a digestion tank and a gas storage but no compensation tank. Gas pressure is created by putting something heavy on the digester or tightening the gas nylon bag with an elastic band. Nylon gas has the following parts:

- Digester (3 nylon layers) put in a prepared hole and covered with bamboo screens. The hole may be constructed by brick or concreted. $V_d = 8m^3$, $V_g = 2m^3$
- Inlet and outlet pipe: Porcelain or PVC pipe
- Gas bag (one nylon layer): hung on the roof of animal stable
- Gas pipe
- Safety valve
- In some cases, a deposit sediment tank and slurry pit can be constructed. [Hai Anh ,2010]

Three quarters of the digester's volume are filled with animal dung slurry through the inlet pipe and one-quarter is reserved for exhaust. Biogas is accumulated at the upper exhausting space of the digester and is flowing up through the gas vent into one gasholder unit. [Nguyen *et al.*, 2012]

This technology has a short lifetime (3-4 years), is easily exposed to damages due to environment or animal bite, request a large space, has a low efficiency (because of low gas pressure) especially in winter (too cold) and there is no quality control. However, it is not expensive (initial cost of investment not so remarkable) so it is perfect for low income household or for those which don't want to increase their animal production, the material is available in the area and the construction is fast. It is popular in the South. [Hai Anh, 2010]

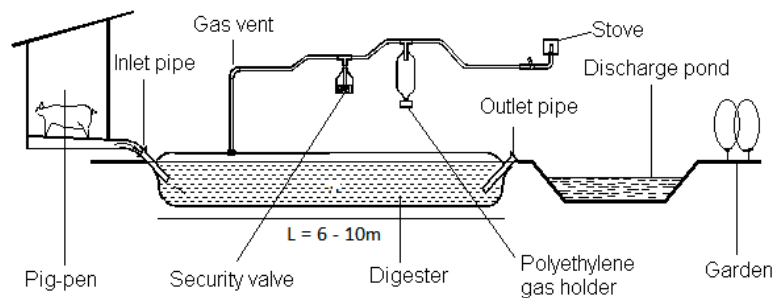

Source: Nguyen *et al.* 2012



Picture source: Wageningen UR Livestock Research 17/08/12

- Covered lagoon

This technology is a manure storage lagoon with a cover, which traps gas produced during the manure decomposition. The lagoon is suitable for liquid manure with less than 3% solids and the hydraulic retention times are from 30 days to 55 days. For this type of digester, an impermeable floating cover covers all or part of the lagoon. A concrete footing along the edge of the lagoon holds the cover in place with an airtight seal. The CH₄ produced in the lagoon is collected under the cover. A pipe extracts the gas for use. Covered lagoon digesters require large lagoon volumes and a warmer climate. Covered lagoons have low capital costs for the digester volume itself, but these systems are not suitable for locations in cooler climates or where a high water table exists. The membrane to cover the lagoon is in HDPE (imported from Thailand or Taiwan). The disadvantages of such lagoon are: it occupies a large surface area, sediments blocks 30-40% of the treatment volume after 5-6 years of operation (need a cleaning of the lagoon, which never happens so the efficiency is reduced) [GFA a, 2011].

- VACVINA

This model has been developed in Viet Nam in 1998. It is an innovative, low-maintenance and easy to build model. The siting, similar as all brick and concrete fixed dome biogas plants, reduces land requirements to a minimum (available space is a major problem for many households). On the other hand, its hybrid nature (plastic bag biogas reservoir) helps keep the cost down, and avoids design leakages of methane emissions in an open compensation chamber. Biogas is collected in a separated plastic bag hanging in the stable or kitchen roof. The gas pressure increases by using a rubber rob wrapped around the gas storage bag. Therefore gas burners used for this digester type are the same as for each plastic bag digester. According to Huu Luu *et al.* (2011), 20% of the Vacvina users have less than 5 pigs, 43% have between 6-10 pigs and 28% have between 11 and 20 pigs. 8% of the fixed dome users have less than 5 pigs, 30% have 6-10 pigs and 42% have between 11 and 20 pigs. It appears that the domes (KT1/2) could request more animals than Vacvina to be as efficient.

Appendix XII: Details about the digesters in the USA

The schema at the end of this appendix presents the choice of a digester type for some kind of manure handlings.

○ The plug flow digester

These digesters have a long and narrow heated tank, often built underground. They request a high solid content (11-13%), so can be used especially in dairy farms. As they are heated, they stay at a constant temperature all the year, and so can maintain a constant gas production. [USEPA a 2006]. They usually operate at mesophilic or thermophilic temperature and are working well with a scrape manure management system. The retention time is 15-20 years. In theory, manure flows as a plug, and move through the outlet when new manure is added. Then, it can be discharged over an outlet weir, while maintaining a gas tight atmosphere. But in practice, a different process can occur: the manure does not remain as a plug and some of the manure flow through the digester faster than others and some parts stay in the digester. Then, the biogas produced is used to heat the digester. The excess of biogas can be used for the engine generator. Heat can also be recovered from the engine generator and used for space or water heating for example. The excess of biogas can also be used to produce electricity, using an engine generator, to offset the cost of purchased electricity, propane, natural gas or fuel oil²⁷.

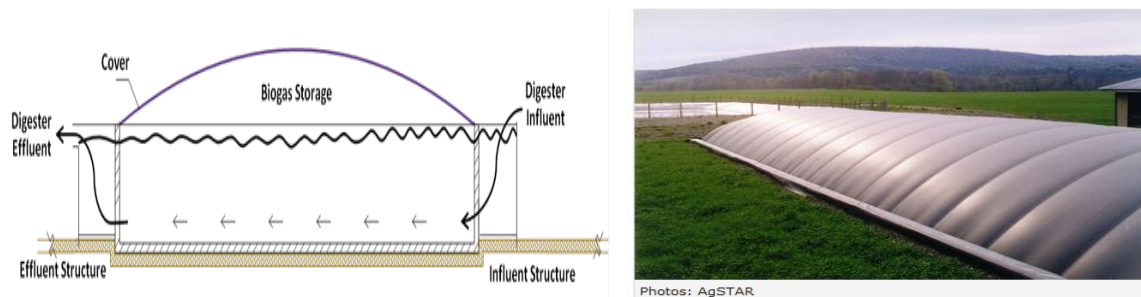

Source: USEPA AgSTAR: <http://www.epa.gov/agstar/anaerobic/ad101/anaerobic-digesters.html>

○ The complete mix digester

These digesters have a mixing tank where manure accumulates before going into the digester. Pumps and gravity are used to move the manure in the system. These digesters are also made up of a vertical cylinder, and are made of steel or concrete with a gas-tight cover. As they are also heated, they stay at a constant temperature all the year (can work at mesophilic or thermophilic temperature), and so can maintain a consistent gas production. But they are more common in the warm climates, where manure is flushed with water, which lower the solid content up to 3-10%. They can be used in dairy and swine farms. [USEPA a 2006]. The gas is trapped with a gas-tight cover. Retention time is 10-20 days. The gas can then be used to heat the digester. The excess of gas can be used for the engine generator. Heat can also be recovered from the engine generator and used for space or water heating for example. The excess of biogas can also be used to produce electricity, using an engine generator, to offset the cost of purchased electricity, propane, natural gas or fuel oil²⁸.

²⁷ Source : <http://www.biogas.psu.edu/plugflow.html> visited on the 25/08/12

²⁸ Source : <http://www.biogas.psu.edu/completemix.html> visited on the 25/08/12

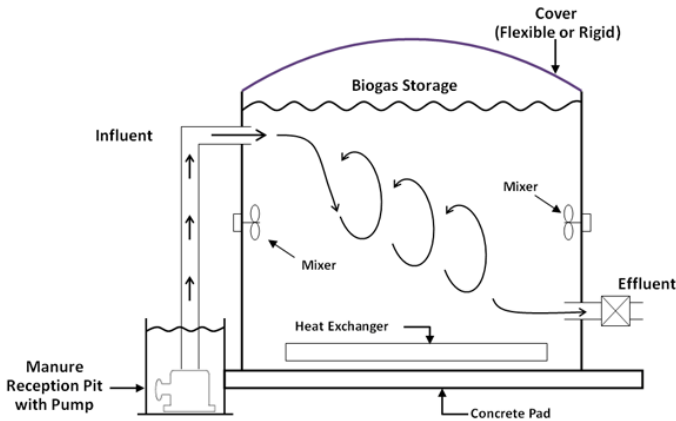

Source: USEPA AgSTAR: <http://www.epa.gov/agstar/anaerobic/ad101/anaerobic-digesters.html>

○ The fixed film digester

These digesters are usually heated (mesophilic or thermophilic temperature) tanks packed with inert media on which the bacteria can grow as a biofilm (the wastewater goes through the media and the anaerobic microbes attach to it, which create a biofilm, a layer of anaerobic bacteria). They request a low solid content, for example when the manure is diluted with water. They could be used in dairy and swine farms. [USEPA a 2006]. The microbes on the biofilm will contribute to remove some materials in the wastewater. When the effluent is discharged, the bacteria stay attached to the media and can be used again for the next influent. The retention time is 3-5 days. The gas can be used to heat the digester. The excess of gas can be used for the engine generator. Heat can also be recovered from the engine generator and used for space or water heating for example. The excess of biogas can also be used to produce electricity, using an engine generator, to offset the cost of purchased electricity, propane, natural gas or fuel oil²⁹.



Source: USEPA AgSTAR

²⁹ Source : <http://www.biogas.psu.edu/othertypesmod.html> visited on the 25/08/12

○ The covered lagoon

The methane is capture by the lagoon, which is covered by a flexible or floating gas tight cover. The manure is stored and the gas is piped out to be flared or used on-farm. They request a low solid content (less than 3%) and can be used for swine and dairy manure. They are not heated, so the quantity of gas available varies over the year and less gas is produced when the temperature is low. This is why the farms that have this digester and are located in the regions that have a high year round temperature, can produce biogas for energy (heat recovery can be used to heat swine nursery for example), reduce odors or increase the nutrient content of the effluent. These digesters are not expensive and are considered to be a simple technology available in the developed and developing countries (whereas the 3 technologies presented above are present in developed countries only). [USEPA a 2006]. The retention time is quite long (30-45 days) and the dilution factor is high. They are typically used with a flush manure management system. Sometimes, if they have enough biogas produced, these digesters can use an engine generator. If they don't (colder climate), then the biogas is just flared for odor control and GHGs reduction³⁰.

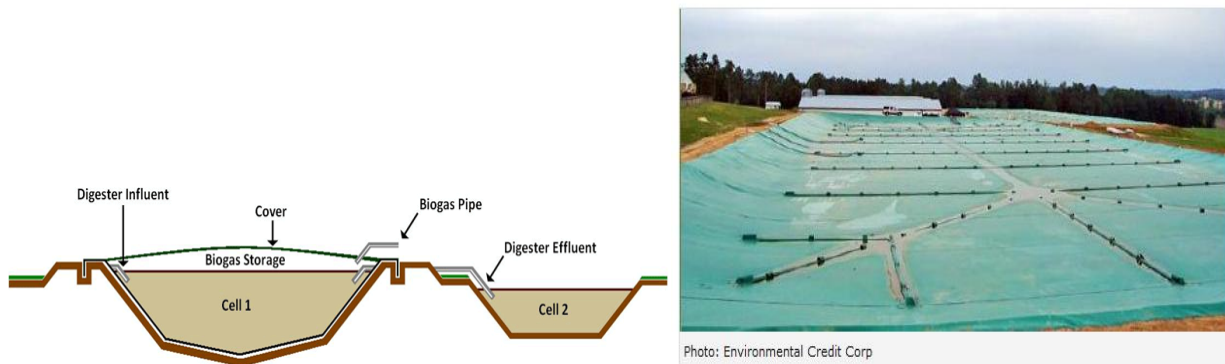

Sources: USEPA AgSTAR: <http://www.epa.gov/agstar/anaerobic/ad101/anaerobic-digesters.html>

	Total Solids (%)						
	0	5	10	15	20	25	30
Manure	Water Added			Bedding Added			
	As Excreted						
Classification	Liquid		Slurry		Semi-Solid		Solid
Handling Options	Pump		Scrape			Scrape and Stack	
Biogas Production	Recommended				Not Recommended		
Digester Type	Covered Lagoon or Attached Media		Complete Mix		Plug Flow		

Source: AgSTAR, no date

³⁰ Source : <http://www.biogas.psu.edu/coveredlagoon.html> visited on the 25/08/12

Appendix XIII: Consequences of the change of the capital cost (with the inflation rate) in the USA (above) and Vietnam (below)

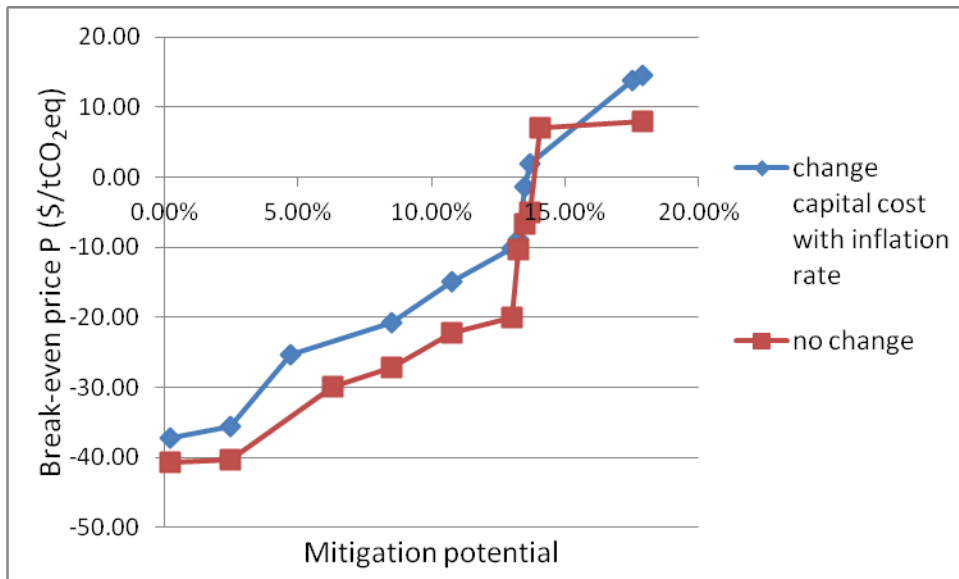
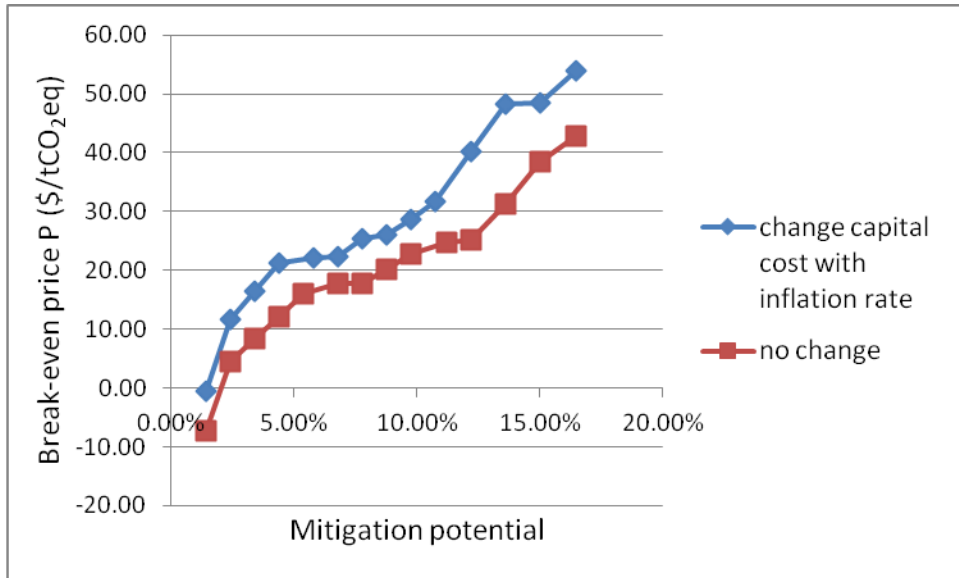

Appendix XIV: USEPA (2006) results for the USA and Vietnam before tax

○ USA MAC curves

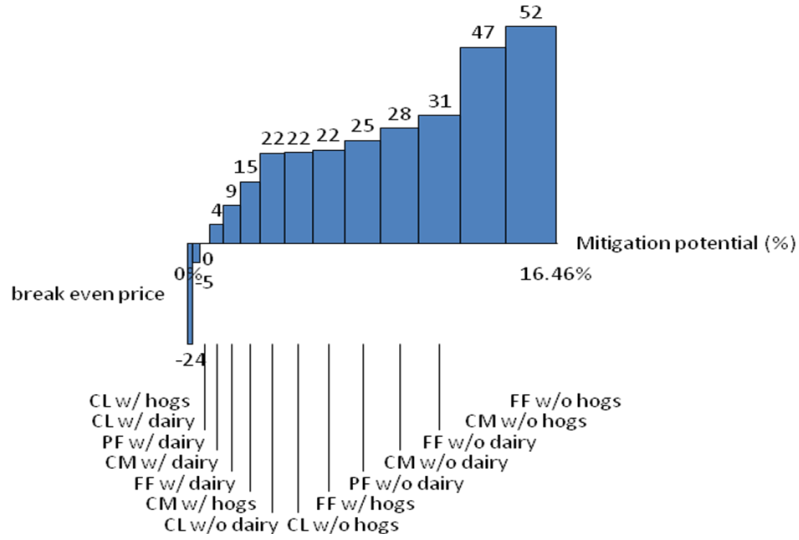

○ USA mitigation potential

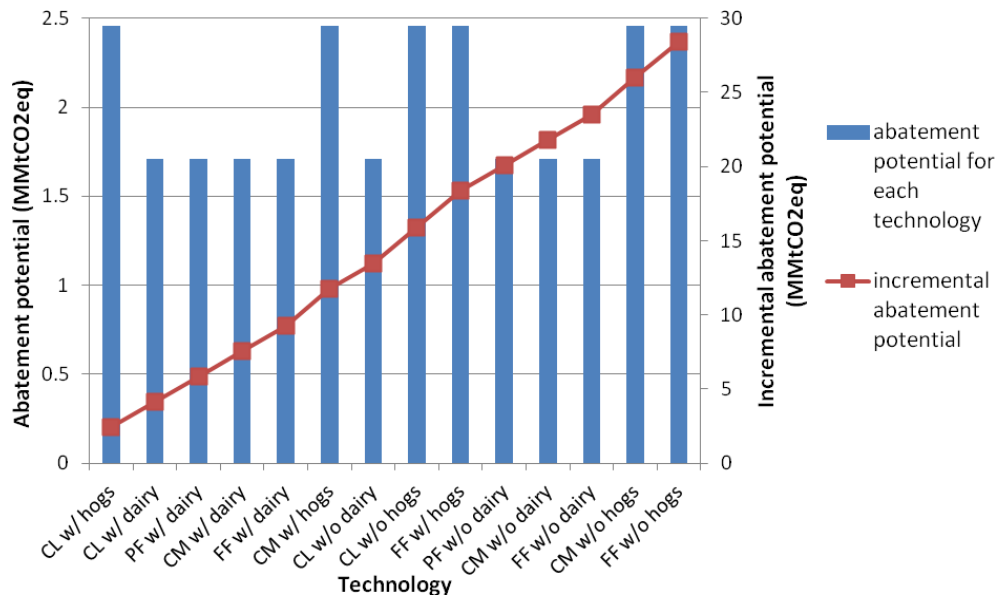

○ Vietnam MAC curves

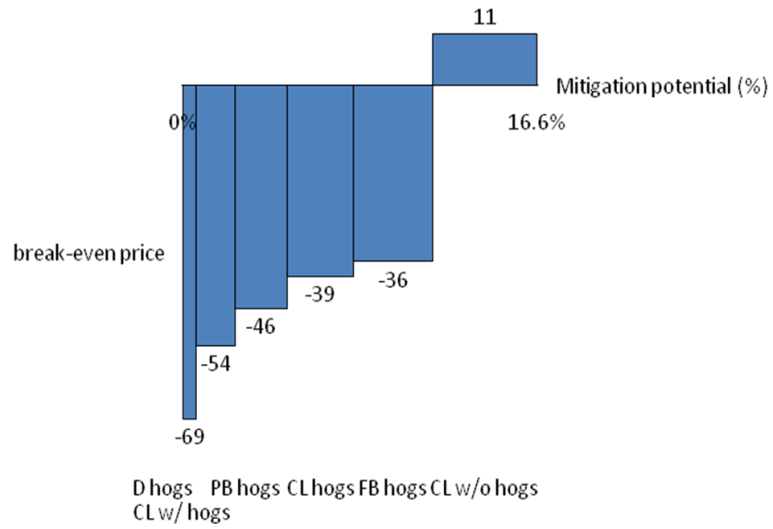

○ Vietnam abatement potential

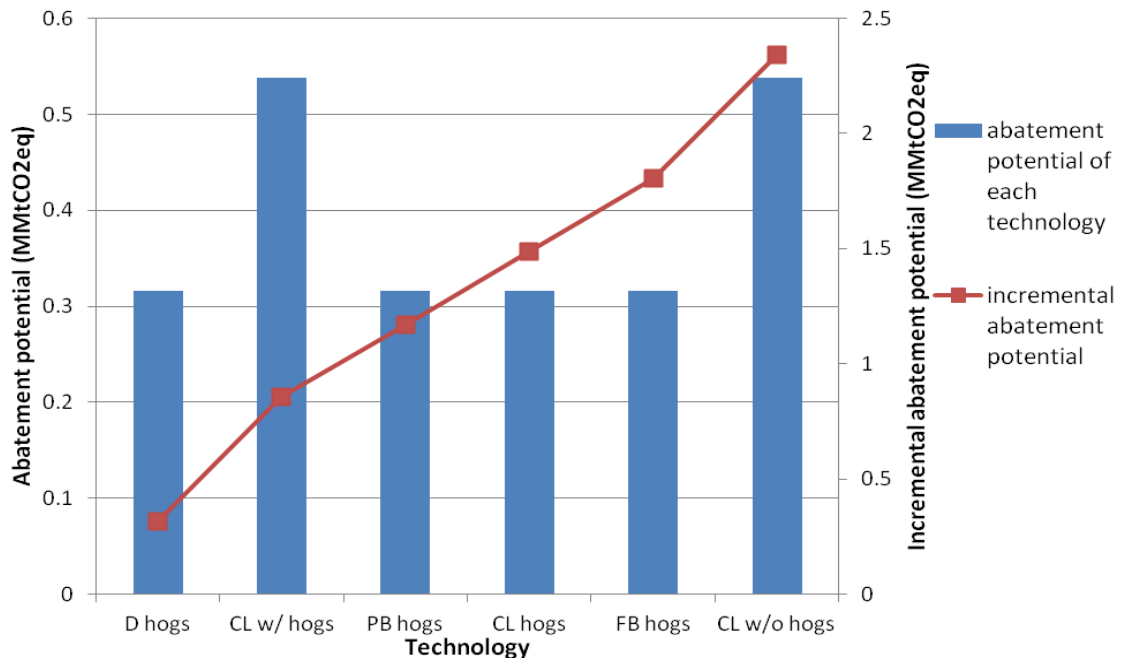

Appendix XV: Cost-benefit analysis for a covered lagoon in a 940 pig farm (Payback method)

Costs		Benefits		Payback period
Tank	5302	Electricity sales	5870	With grants: $398651/8348 = \underline{48 \text{ years}}$ Without grants: $731535/8348 = \underline{88 \text{ years}}$
Pumping and	21865	REC	4696	
mixing	84375			
Piping	126706			
Digester	267233			
Building	226054			
Other				
Total capital costs	731535			
- Possible grants	332884			
Net cost	398651	Yearly benefits	5870+4696-	
O&M	2218		2218= 8348	

Source: RCM international, 2012

This cost-benefit estimate has been done for a farm size far below the minimal number of animal requested to run a digester in a profitable way according to AgSTAR in North Carolina, the first state for pig production. This table summarizes the costs and potential benefits of such a project. In this case, the farmer will finish paying his initial investment after 48 years if he had helps from USDA and NCRS for building the digester (which is not always the case and the amount of the grants changes from state to state). If he had not, the payment will be “refunded” only 88 years afterwards. This project is too expensive for the little amount of benefits that the farmer could have. This is why a minimum number of animals in the farms to produce a minimum amount of biogas could be necessary.

Appendix XVI: Inventory and digesters distribution in the USA

- o Dairy inventory and farm size

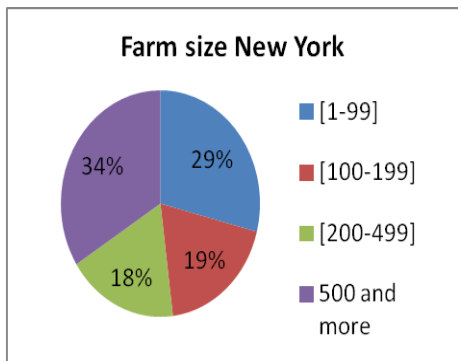
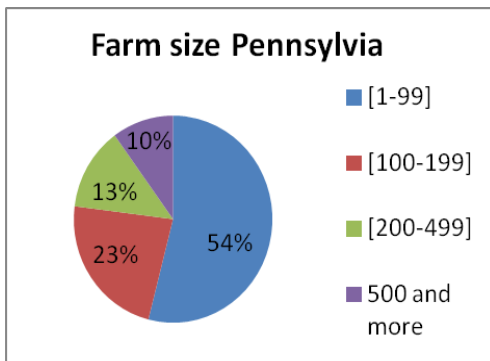
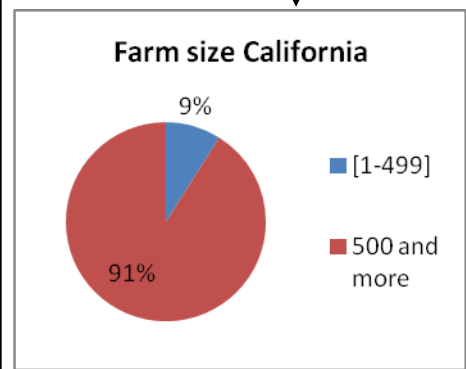
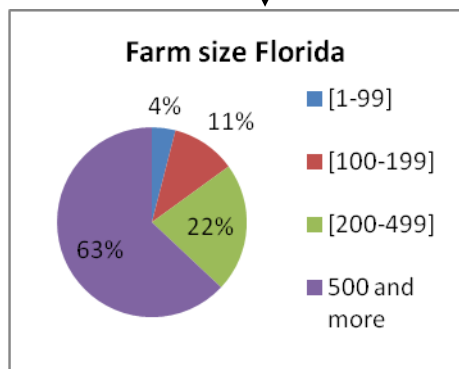
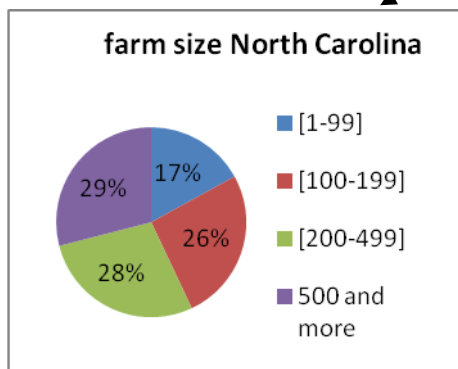
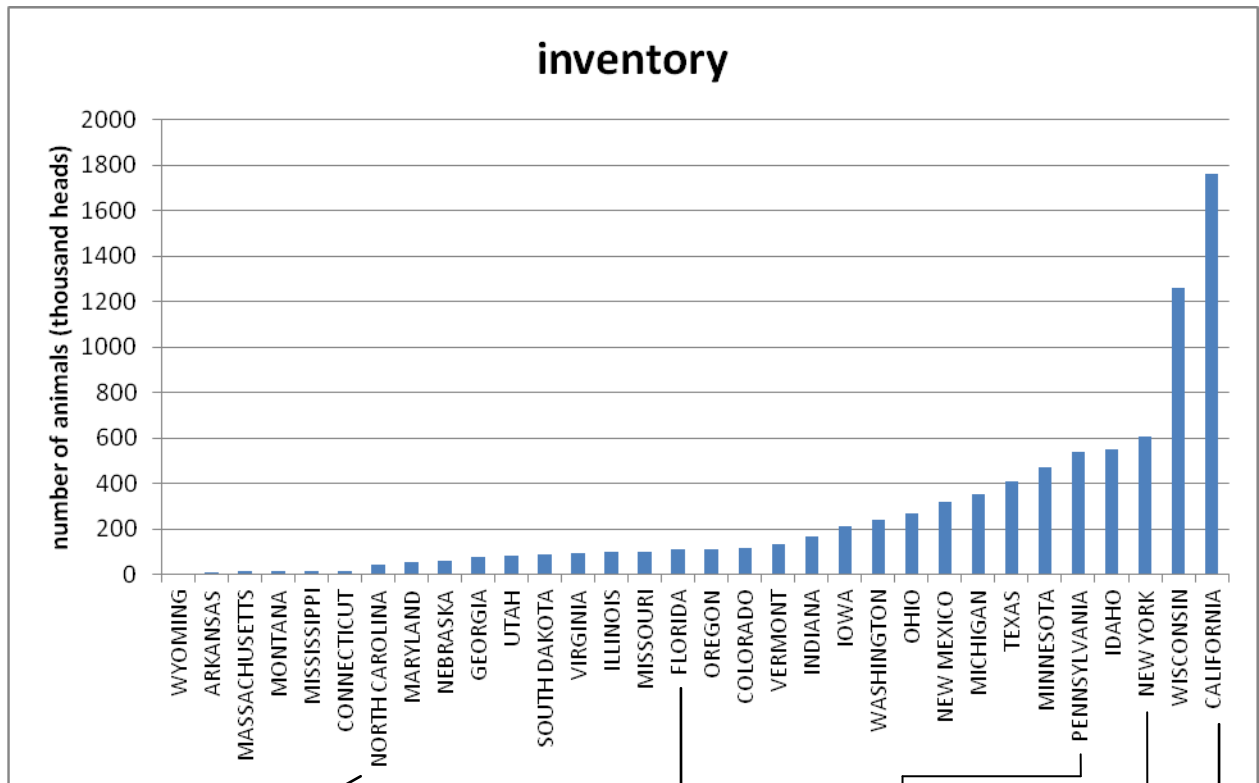

○ Swine inventory and farm size

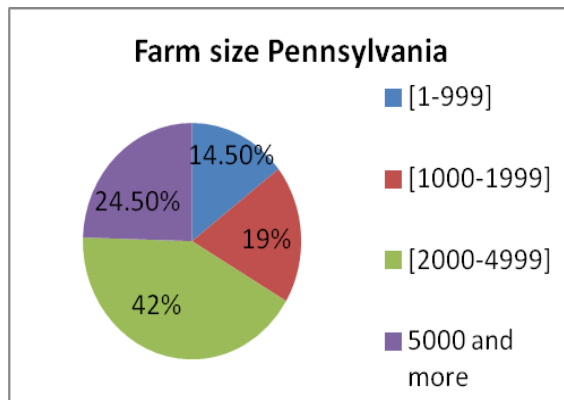
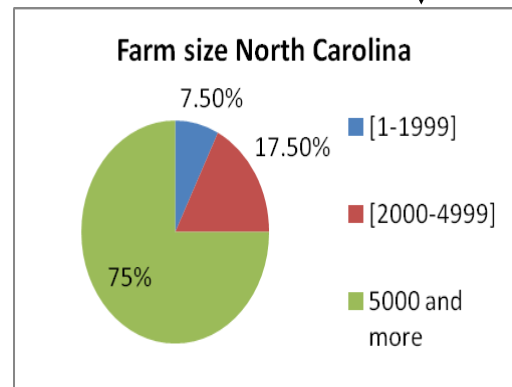
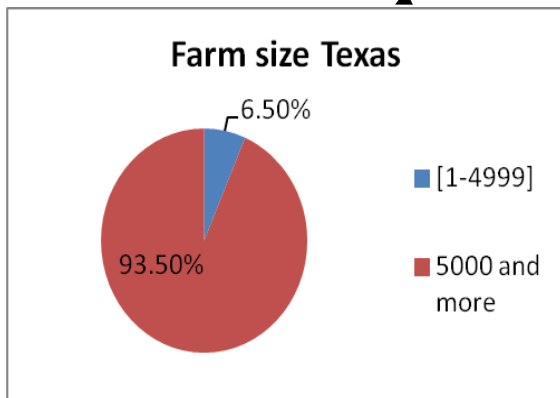
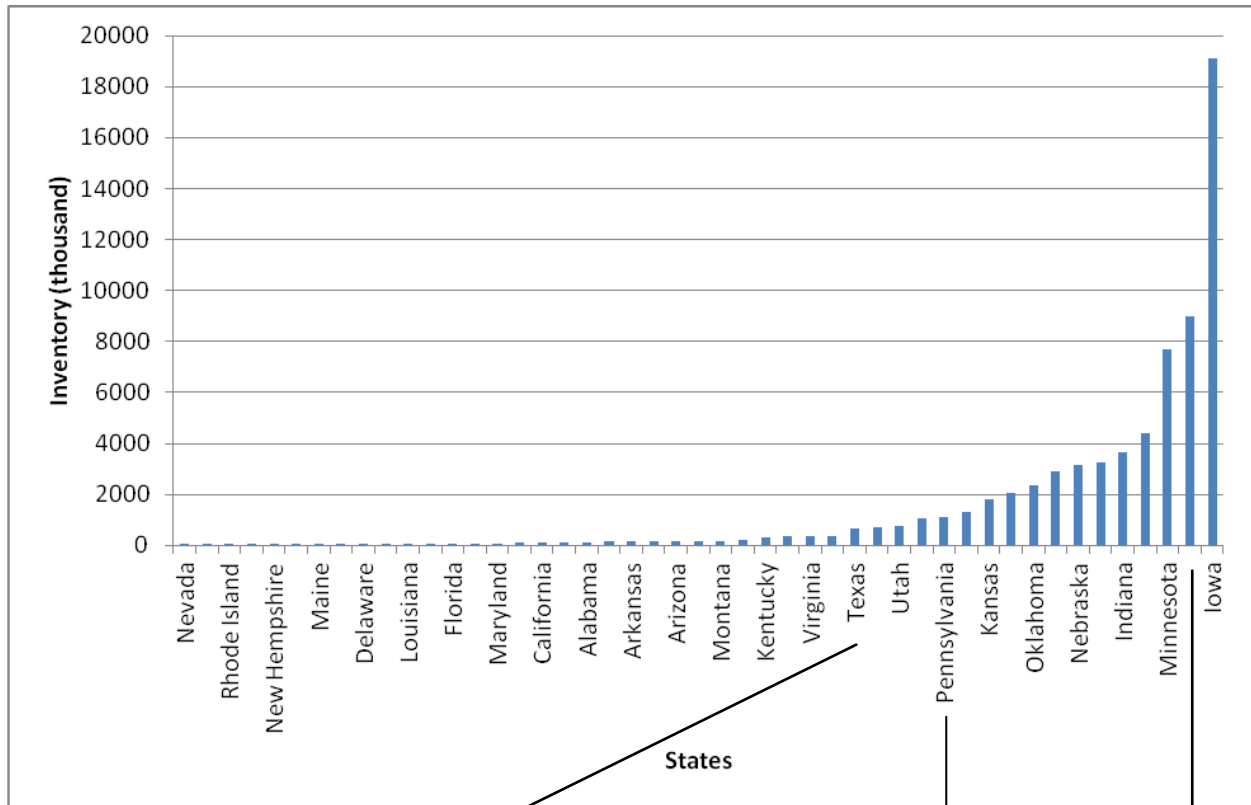

○ Digester distribution

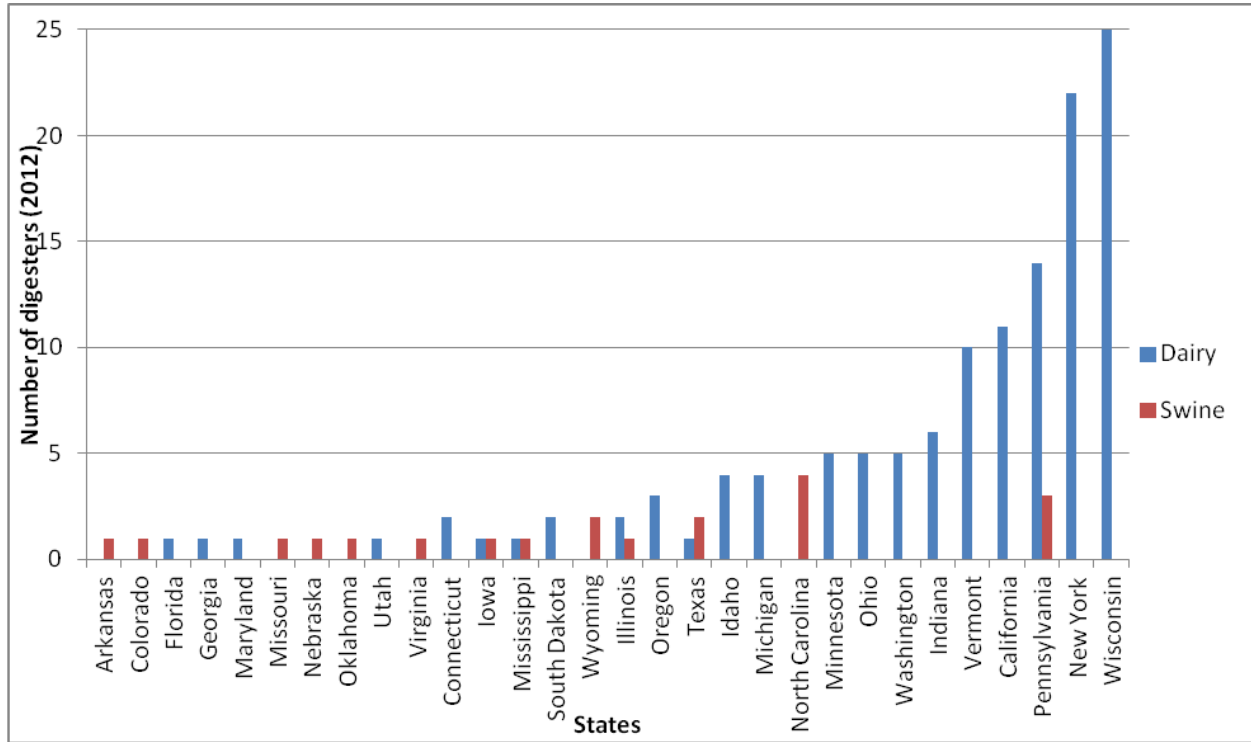

Source graphs: USDA NASS and AgSTAR

Appendix XVII: Climate zones in the USA and the digesters distribution

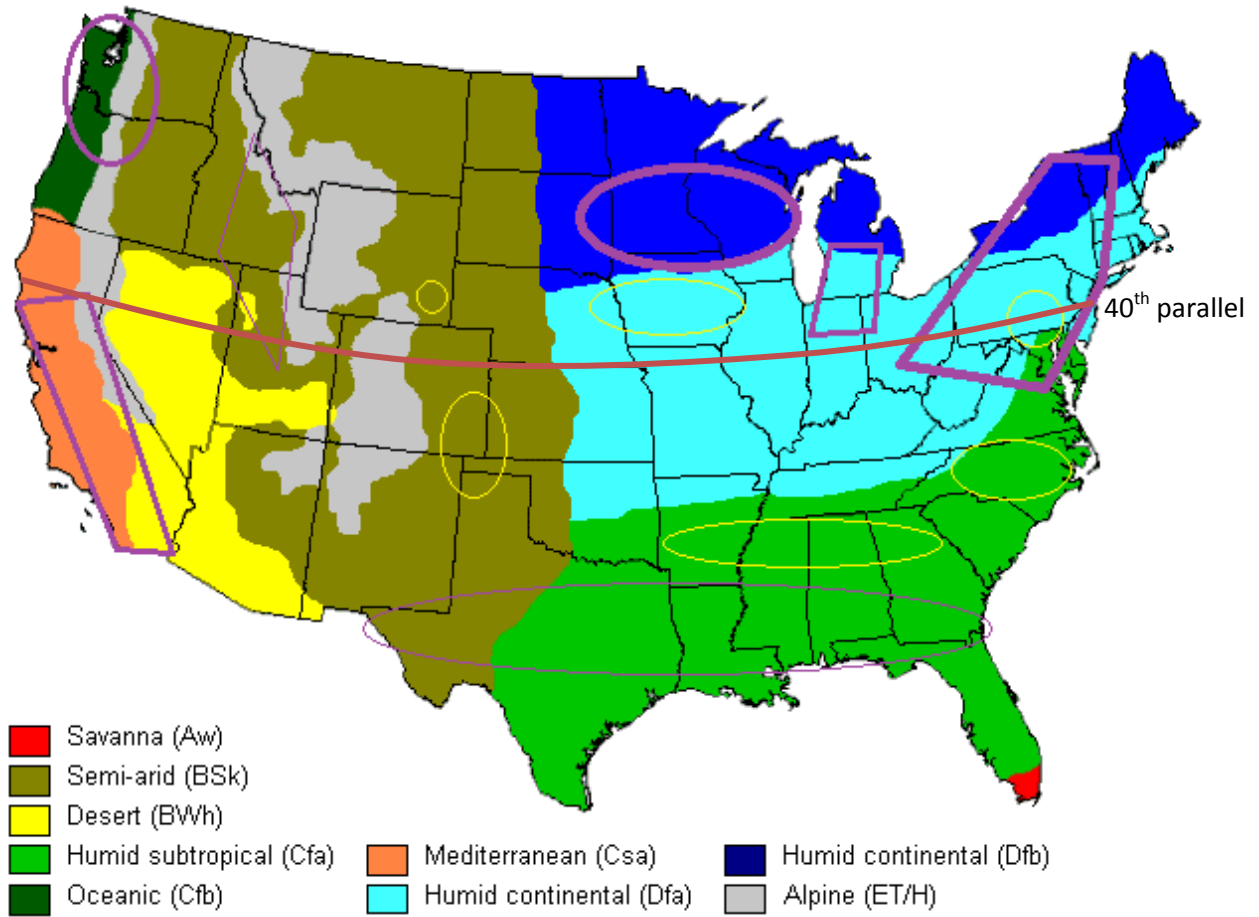

The digesters in the dairy farms are within the purple outline and the ones in the pig farms are within the yellow outline. The more the outline is thick, the more digesters are found in this place.

Appendix XVIII: Methodology used for the geographic distribution study

We said that, because the lagoon is unheated, it will request to be built in states where there is low temperature variability, and a warm climate. Indeed, covered lagoons require large capacities to treat the liquid manure properly at low temperatures (which is expensive and usually not cost-effective). Therefore, covered lagoons for energy recovery (electricity and heat) are feasible only in moderate to warm climates, where additional heat will not be required. Thus we consider that the states above the 40th parallel could not build this kind of digester. So the lagoon could be applied to 50% of the territory. In the colder state, some lagoon could be built but only to solve odor problems. As the aim of the study is to take into account the energy recovery, we will suppose that no lagoon can be built in the states above the 40th parallel. Then, the lagoon is less efficient than the others digesters, it will request more animals especially for the one that have an engine for electricity production. The USA will be shared into 4 equal zones (North-West, North-East, South-West, and South-East). The North-West part will go from Washington-Oregon to North-Dakota-Nebraska, the South-West includes the states from California to Kansas-Texas, The South-East includes Missouri, Kentucky, Virginia and the southern states, and the rest represents the North-East part. 47.2% of the dairy cows are in the North-East of the USA, 33.6% are in the South West, 12.1% are in the North West and 7.1% are in the South East, according to USDA NASS in 2010. Moreover, among 29 states where the inventory could have been found in 2007 (no data after 2007), half of them have more than 500 cows and they are almost all located at the west part of the USA. Thus, we consider that the lagoon with an engine applies to 25% of the territory (low temperature variation and big herd size in the South West of the USA) and 33.6% of the dairy cows, and those without an engine apply to 7.1% of the dairy cows (South East). For pigs, 61% of them are in the North East of the USA, 21.3% are in the South East, 10.1% are in the South West and 7.5% are in the North West and almost all the states where the inventory per herd size could have been found have more than 2000 pigs. Thus we consider that lagoon in pig farm apply to 50% of the territory. The one with an engine can apply to 21.3% of the pigs in the South East and the one without can apply to 10.1% of the pigs in the South West. For the heated digesters (plug flow, complete mix and fixed film) in dairy farms, they do not have the problem of the temperature variation, and they are more efficient, so they could be applied to the whole territory and all types of farms.

So, the information given above enables us to have a geographical distribution of the technologies according bio-physical parameters, without any consideration of the economics. However, we need to use the results of this study to be able to distinguish the heated digesters that could be applied everywhere. Thus, we need to take into account the price of each technology among the region where we could find many technologies to avoid double counting effects. For the pig farms, the complete mix with an engine appeared to be cheaper than the plug flow and the North East part has the highest amount of animals, so we will suppose the complete mix will be especially applied in this part and will concern 61% of the pig population. Thus the plug flow with engine will be supposed to be especially applied in the North-West part of the country and will concern 7.5% of the animals (here we suppose the farmers can obtain the high solid content requested for this technology while adding co-products). For dairy farms, most of the animals can be found in the North-East part and the cheapest technologies are the plug flow and the complete mix with an engine

(this also the part where most of the technologies in 2010 have been adopted). Thus, we will suppose these 2 technologies will be the most applied in this part of the USA and will be adopted equally. Thus, each one of these options will concern 23.6% of the dairy cows. And finally these options without engine and the fixed film digester will be assumed to be the most applied in the North West part of the USA and they will also share the same amount of animals. Thus, each one of them will concern 4% of the animals.

Appendix XIX: Vietnamese regions and comparison of 3 regions

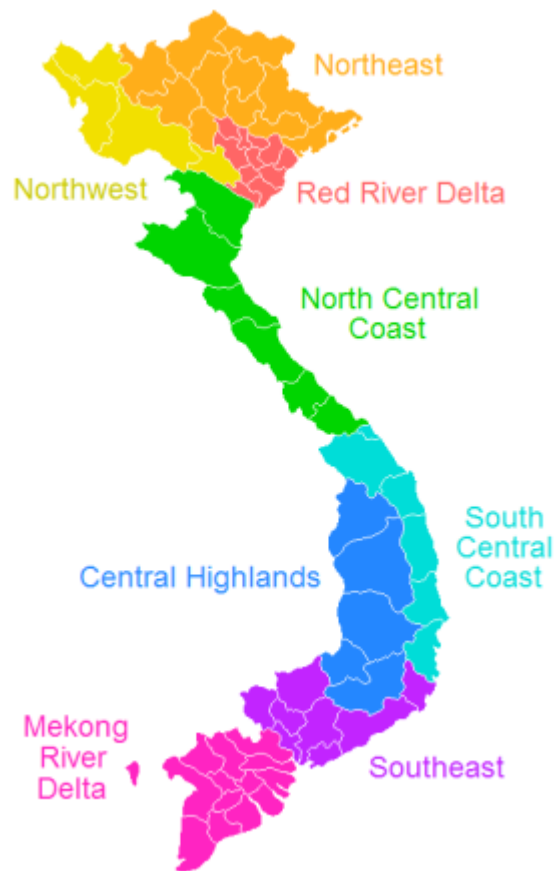

Source: Eastern Research Group (2010)

A comparison of 3 regions (Northern Mountain, North Central and South Central) in Vietnam and 2 digesters has been done by Huu Luu *et al.* in 2011. In the mountain area, the animal husbandry represents 30.2% of the activities, the mean temperature is 22.4°C, 1500 digesters can be found in 2008 (there are not a lot of pig farms in this area). In the North Central region (more than 1 million pigs, with an average of 18 animals per households, 66% of the biogas users have between 10 and 20 pigs), 89.6% of the households are rural, the mean temperature is 23-24°C, 8000 digesters can be found (especially domes), the humidity is 85-87%. Finally in the South Central region, we can found even less pigs than in the mountain area, thus the number of digesters is also lower (800), especially the dome digesters, the temperature is 26,7°C, and the humidity is 79%.

Appendix XX: Picture of a failed lagoon



Source: Matthew Carr, Advisor Renewable Energy, SNV, 25/06/12

Appendix XXI: Comparison of the MAC curves under 2 implied adoption rate assumptions in Vietnam

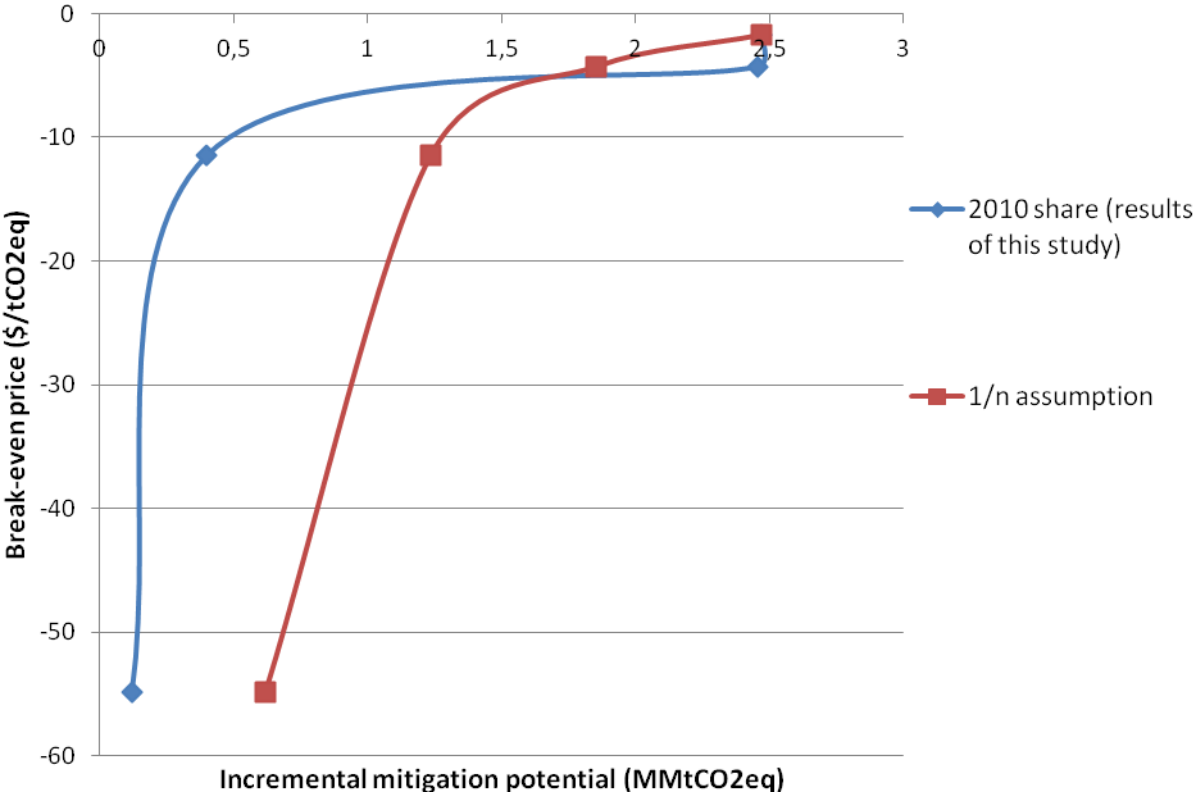

Appendix XXII: Financial analysis for Vietnamese digesters

The following payback period have been calculated while using a forecast escalation rate of fuel price of 2% per year [Hai Anh, 2010]

- Nylon (plastic or polyethylene) bag pigs

	year	0	1	2	3
total investment cost	US\$	-199.9			
total benefit substitution fuel	US\$	0	103	105	107.1
total	US\$	-199.9	-96.9	8.1	115.2
payback	year	2			

- KT1/2 pigs

	year	0	1	2	3	4	5	6	7	8
total investment cost	US\$	-492.4								
total benefit substitution fuel	US\$	0	98	99.96	101.96	104	106.1	108.2	110.4	112.6
total	US\$	-492.4	-394.4	-294.4	-192.5	-88.5	17.6	125.8	236.2	348.8
payback	year	5								

- Composite pigs

	year	0	1	2	3	4	5	6	7	8	9
total investment cost	US\$	-619									
total benefit substitution fuel	US\$	0	95	96.9	98.8	100.8	102.8	104.9	107	109	111.3
total	US\$	-619	-524	-427.1	-328.3	-227.5	-124.7	-19.8	87.2	196.2	307.5
payback	year	7									

Appendix XXIII: Effect of the change in the discount rate in Vietnam (10% above, 13% below)

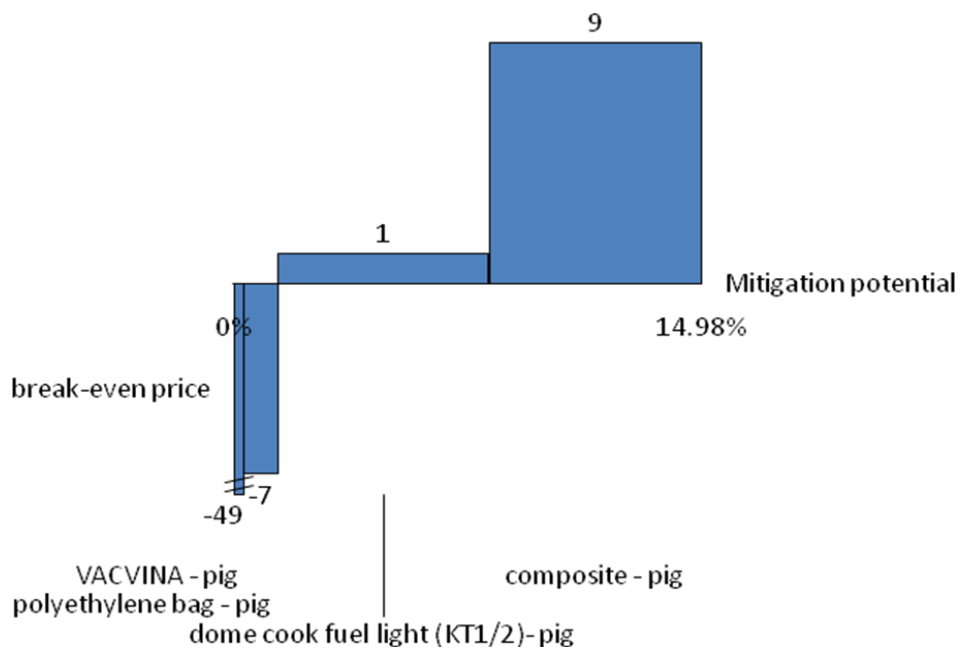
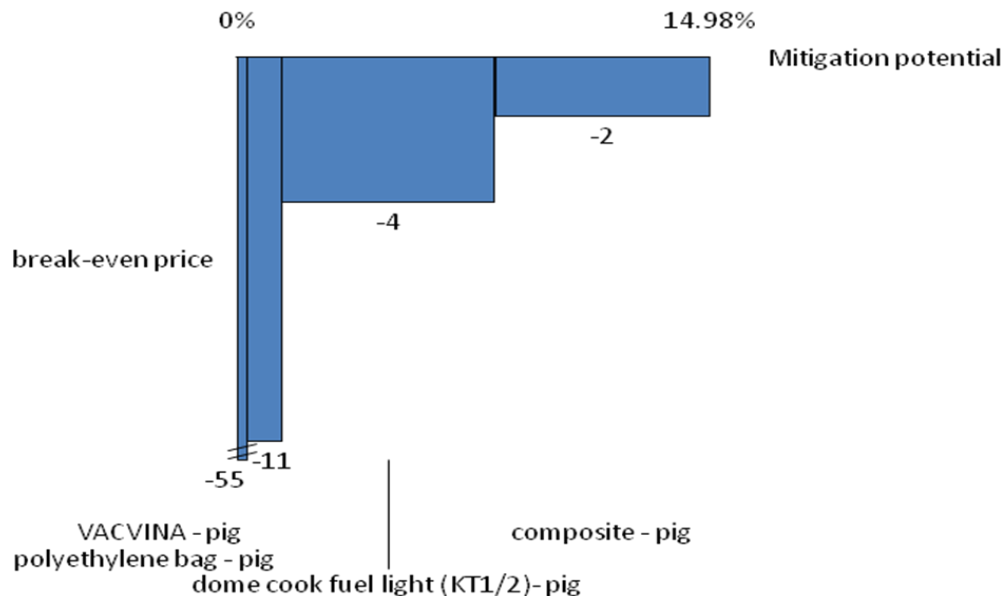

Appendix XXIV: Methodology for the MAC curves building while taking into account a progressive adoption rate (5 or 10%) and extract of the break-even price calculation (10% rate)

For one digester type, we consider that the costs and revenues used in this study are representative of a “mean” single farm. Then we take a sample of 100 farms (all the same), and we suppose the full adoption of the technology the first year (everything is multiplied by 100). Here again, the emission reduction without implied adoption rate is calculated to be used for the break-even price formula. We can see that indeed, the break-even price, calculated with the same methodology than before, is the same than with the single farm. Then, among these 100 farms, we will suppose that only 10% the first year adopt the technology (and 20% the second year, 30% the third, and so on, 100% from the 10th to the 20th year). So, the first year, the costs, revenue and emission reduction found for the single farm will be multiplied by 10. The capital annuity (capital cost/S, CA) is calculated because the S factor presented before applies only to the capital costs. All the parameters are annualized. Then, for the following year until the 10th, the capital costs are always the same because each year the same amounts of farms adopt the technology. The capital annuity is thus, the total capital cost of these 10 extra farms divided by S plus the capital annuity of the past year which is actually the same. So the capital annuity of the second year $CA_2 = CA_1 * 2$, the one for the third year is $CA_1 * 3$ and so on. The second year, the labor costs, revenue and emissions reduction are the one for the single farm multiplied by the number of farms that adopt the technology, namely 20, and so on until the 10th year. The break-even price calculation is always the same and the amount does not change over the time. The 10th year, we have the full adoption, then from the 11th to the 20th year, the capital costs are inexistent, and the capital annuity, labor cost, revenue, and emission reduction are always the same than the 10th year’s ones. The break-even price never changes. The following tables present an example of the break-even price calculation with this methodology for the plug flow digester in the USA with an adoption rate of 10% per year. Then only the abatement potential will change over time and its incremental value is not the same if we consider the full adoption the first year, or an adoption rate (10% or 5%).

Single representative farm per t output	
CC	423.3446
VC (labor) per yr	1.80
VC (labor) tot	36
Time period	20
Rev elect yr	91.08634
Tot rev	1821.727
ER per yr	0.605458
ER total	12.1
S	8.513564
P _{new}	-65.3
discount rate	10%
Capital annuity	49.7
ER per yr X axis	0.298188
ER per year X axis (MMtCO ₂)	5.461476

	year 1	year 2	year 3	year 4	year 5	year 6	year 7	year 8	year 9	year 10	year 11
CC	42	42	42	42	42	42	42	42	42	42	-
VC (labor) per yr	0.18	0.36	0.54	0.72	0.90	1.08	1.26	1.44	1.62	1.80	1.80
Time period	20	20	20	20	20	20	20	20	20	20	20
Rev elect yr	9	18	27	36	46	55	64	73	82	91	91
ER per yr	0.06	0.12	0.18	0.24	0.30	0.36	0.42	0.48	0.54	0.61	0.61
ER total	1	2	4	5	6	7	8	10	11	12	12
S	8.51	8.51	8.51	8.51	8.51	8.51	8.51	8.51	8.51	8.51	8.51
P _{new}	-	-	-	-	-	-	-	-	-	-	-
No. farms adopt:	10%	20%	30%	40%	50%	60%	70%	80%	90%	100%	100%
Capital annuity	5	10	15	20	25	30	35	40	45	50	50
ER per yr X axis	0.03	0.06	0.09	0.12	0.15	0.18	0.21	0.24	0.27	0.30	0.30
ER per year X axis (MMtCO ₂)	0.55	1.09	1.64	2.18	2.73	3.28	3.82	4.37	4.92	5.46	5.46

Appendix XXV: AgSTAR assumption test (500 cows, 2000 pigs)

○ Pigs

number of animals	0	940	2000	1793	2504
power produced (kWh/yr)	0	117404	249795		
power produced per head (kWh/yr)	0	124.8979	124.8975	124.8975	124.8975
total cost (\$)	0	731535	738614		
cost per head (\$/head)	0	778.2287	369.307	448.982	174.8565
grants USDA (\$)	0	182883.8	184653.5		
grants USDA per head (\$/head)	0	194.5572	92.32675	112.2455	0
grants NRCS (\$)	0	152167.2	323760		
grants NRCS per head (\$/head)	0	161.88	161.88	161.88	0
net cost (\$)	0	396484.1	230200.5		
net cost per head (\$/head)	0	421.7915	115.1003	174.8565	174.8565
electricity sales (\$/yr)	0	5870.2	12489.75		
electricity sales per head (\$/yr)	0	6.244894	6.244875	6.244875	6.244875
Renewable Energy Credit (\$/yr)	0	4696.16	9991.8		
REC per head (\$/yr/head)	0	4.995915	4.9959	4.9959	4.9959
O&M costs (\$/yr)	0	2348.08	4995.9		
O&M costs per head (\$/yr/head)	0	2.497957	2.49795	2.49795	2.49795
yearly benefits (\$/yr)	0	8218.28	17485.65		
yearly benefits per head (\$/yr/head)	0	8.742851	8.742825	8.742825	8.742825
payback with grants	0	48.24416	13.16511	20	
payback without grants	0	89.01315	42.24115		20

Explanation of the calculations for a 20 years payback with grants:

$$\text{Payback (yr)} = \frac{\text{net cost (\$/head)}}{\text{yearly benefits (\$/head/year)}}$$

$$\longleftrightarrow \text{Net cost (\$/head)} = \text{payback} * \text{yearly benefits per head (\$/head/year)}$$

The yearly benefits per head do not change, thus it is possible to know the value of the net cost for a payback of 20 years.

$$\begin{aligned} \text{Net cost (\$/head)} &= \text{total cost (\$/head)} - \text{grants USDA per head} - \text{grants NRCS per head} \\ \text{Net cost (\$/head)} &= \text{total cost (\$/head)} - 25\% * \text{total cost (\$/head)} - \text{grants NRCS per head} \\ \text{Total cost (\$/head)} &= \frac{\text{Net cost (\$/head)} + \text{grants NRCS per head}}{75\%} \end{aligned}$$

Here again, the grants NRCS per head do not change (it is always \$760 for 1000 lbs of animal), so it is possible to know the value of the total costs per head for a 20 years payback.

The following graph represents the evolution of the total cost per head according to the number of animals

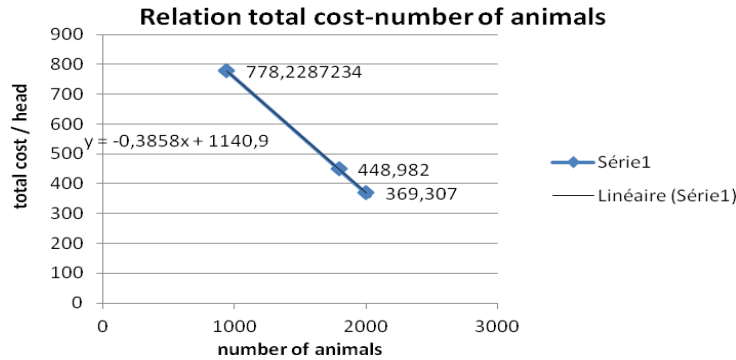

Then, the equation of the curves (approximation by a trend line) leads to the number of animal requested (x axis) for the cost which correspond to the 20 years payback (y axis).

o Dairy cows

number of animals	0	500	1000	583	
power produced (kWh/yr)	0	838690	1677381		
power produced per head (kWh/yr)	0	1677.38	1677.381	1677.381	1677.381
total cost (\$)	0	1738463	2401771		
cost per head (\$/head)	0	3476.926	2401.771	3298.329	4956.898
grants USDA (\$)	0	434615.8	500000	0	
grants USDA per head (\$/head)	0	869.2315	500	0	1239.225
grants CFA (\$)	0	209673	419345	0	
grants CFA per head (\$/head)	0	419.346	419.345	0	419.345
net cost (\$)	0	1094174	1482426		
net cost per head (\$/head)	0	2188.349	1482.426	3298.329	3298.329
electricity savings (\$/yr)	0	34905	69810.04		
electricity savings per head (\$/head/yr)	0	69.81	69.81004	69.81004	69.81004
electricity sales (\$/yr)	0	27996.75	55993.54		
electricity sales per head (\$/yr/head)	0	55.9935	55.99354	55.99354	55.99354
hot water savings (\$/yr)	0	14260	29201		
hot water savings per head (\$/yr/head)	0	28.52	29.201	28.8605	28.8605
Bedding (\$/yr)	0	21900	43800		
bedding per head (\$/yr/head)	0	43.8	43.8	43.8	43.8
O&M costs (\$/yr)	0	16773.8	33547.62		
O&M costs per head (\$/yr/head)	0	33.5476	33.54762	33.54762	33.54762
yearly benefits (\$/yr)	0	82287.95	165257		
yearly benefits per head (\$/yr/head)	0	164.5759	165.257	164.92	164.92
Payback (yr)	0	13.2969	8.97043		20
payback w/o grants (yr)	0	21.12658	14.53355	20	

Here we supposed that the yearly benefits per head do not change to simplify the calculations (a mean has been done between the yearly benefits for 500 and 1000 cows). Moreover, it appears that in both case, 55.49% of the power produced correspond to savings (so that is the amount of power the farm needs) and that the rest (44.51%) is sold.

The same methodology for dairy has been used to calculate the amount of animals requested to have a 20 years payback without grants. With grants, the quantity found is negative, which mean that there is no minimum number; every kind of dairy farm could be profitable if there are these grants.