



HAL
open science

Comparison of the vernacular earthen architecture in Goa (past Portuguese colony in India) and Alentejo (Portugal): local building cultures and conservation approaches

Chenelle Fatima Rodrigues

► To cite this version:

Chenelle Fatima Rodrigues. Comparison of the vernacular earthen architecture in Goa (past Portuguese colony in India) and Alentejo (Portugal): local building cultures and conservation approaches. Humanities and Social Sciences. 2020. dumas-02472739

HAL Id: dumas-02472739

<https://dumas.ccsd.cnrs.fr/dumas-02472739>

Submitted on 10 Feb 2020

HAL is a multi-disciplinary open access archive for the deposit and dissemination of scientific research documents, whether they are published or not. The documents may come from teaching and research institutions in France or abroad, or from public or private research centers.

L'archive ouverte pluridisciplinaire **HAL**, est destinée au dépôt et à la diffusion de documents scientifiques de niveau recherche, publiés ou non, émanant des établissements d'enseignement et de recherche français ou étrangers, des laboratoires publics ou privés.

Mémoire du
Diplôme de Spécialisation et d'Approfondissement — Architecture de Terre et Patrimoine,
DSA-Terre 2016 - 2018



Comparaison de l'architecture vernaculaire en terre
de Goa (ancienne colonie portugaise en Inde) et de l'Alentejo (Portugal):
Cultures constructives locales et approches de conservation

**Comparison of the vernacular earthen architecture in
Goa (past Portuguese colony in India) and Alentejo (Portugal):
Local building cultures and conservation approaches**

RODRIGUES Chenelle Fatima

Conservatrice du patrimoine

Janvier 2020

Directeur d'étude

GANDREAU David, Archéologue, Docteur en architecture, Dipl. DPEA-Terre,
Chercheur associé CRAterre/ Labex AE&CC/ Univ. Grenoble-Alpes





L'ÉCOLE NATIONALE SUPÉRIEURE D'ARCHITECTURE DE GRENOBLE
BP 2636 - 60, Avenue de Constantine, 38036 GRENOBLE Cedex 2

Diplôme de Spécialisation et d'Approfondissement — Architecture de Terre et Patrimoine,
DSA-Terre 2016 - 2018

Mémoire de DSA

**Comparaison de l'architecture vernaculaire en terre
de Goa (ancienne colonie portugaise en Inde) et de l'Alentejo (Portugal):
Cultures constructives locales et approches de conservation**

**Comparison of the vernacular earthen architecture in
Goa (past Portuguese colony in India) and Alentejo (Portugal):
Local building cultures and conservation approaches**

RODRIGUES Chenelle Fatima
Conservatrice du patrimoine, Inde
Soutenance: Janvier 2020

Jury

Directeur d'étude

GANDREAU David, Archéologue, Docteur en architecture, Dipl. DPEA-Terre,
Chercheur associé CRAterre/ Labex AE&CC/ Univ. Grenoble-Alpes

JOFFROY Thierry, Architecte DPLG, CEAA-Terre, HDR,
Directeur de l'équipe CRAterre et de l'Unité de recherche Labex AE&CC / Univ. Grenoble-Alpes

RAKOTOMAMONJY Bakonirina, Architecte DPLG, DPEA-Terre,
Chercheur associé CRAterre/ Labex AE&CC/ Univ. Grenoble-Alpes

SADOZAI Chamsia, Archéologue, Dipl. DSA-Terre, HCA,
Chercheur associé CRAterre/ Labex AE&CC/ Univ. Grenoble-Alpes

Ministère de la Culture et de la Communication
Direction générale des patrimoines



**Comparaison de l'architecture vernaculaire en terre
de Goa (ancienne colonie portugaise en Inde) et de l'Alentejo (Portugal):
Cultures constructives locales et approches de conservation**

**Comparison of the vernacular earthen architecture in
Goa (past Portuguese colony in India) and Alentejo (Portugal):
Local building cultures and conservation approaches**

Illustration de couverture / Cover picture illustration

La maison en terre est celle de la famille RODRIGUES (famille de l'auteur du mémoire),
où RODRIGUES Chenelle a vécu jusqu'à ces huit ans.

.....

The earthen structure is the ancestral house of the RODRIGUES family,
where the author, RODRIGUES Chenelle lived till she was eight.

Illustrateur / Illustrator

AFONSO Lionel

ACKNOWLEDGEMENTS

I owe my gratitude to several people who provided their invaluable assistance during the course of this research project.

GANDREAU David, Research Director, thank you for your guidance all along the duration of this study.

CORREIA Mariana for letting me re-purpose your DPEA-Terre dissertation, 'Le Pise d'Alentejo' (2000), which served as a precursor and set a benchmark for my research. Thank you for supporting my scholarship to visit Portugal, and for your encouragement as well.

AFONSO Lionel for realising all the measure drawings and illustrations, especially for the section on Goa. This project would not have been complete without you.

RYDER Peter (Archaeologist, Historic Buildings Consultant, UK) for editing most of this document. Thank you for your time, patience, and interest.

Fundação Oriente teams for granting me a scholarship to visit Portugal on this research, especially **FIGUEIRA Inês** (Goa) and **CARVALHO Isabel** (Portugal) for managing my scholarship.

Campus France for granting me the Charpak Scholarship 2016-2018 to pursue my DSA-Terre programme.

Dada, **Antonio**; Mama, **Clara**; my brothers, **Clevon** and **Chevon**; and all the **RODRIGUES** family members. Thank you for every little bit that you all did. It summed-up to a lot.

My house-mates in France, **VEDRINE Bénédicte** and **BRIATTE Clothilde**. Thank you for seeing me through as I hustled and bustled, and fell ill while writing this dissertation. I recognise the efforts you made to ease matters for me.

D'SILVA Tallulah (Architect, Goa) for being my mentor, and always being available when I need. A big thank you!

Those in Goa who readily shared content, maps, pictures and other inputs: **BORKAR Rujuta** and **HEGDE Varun** (Soul Travelling, offbeat tourism), **D'SOUZA Muriel** and **MASCARENHAS Mario**, **FERNANDES Noah** (Architect), **LOURENCO Jose** (Engineer), **PEREIRA Saviana**, and **RODRIGUES Viola**. **MESQUITA Savio**; Uncle, **RODRIGUES Lawrence**; and **VELIP Nilkanth**, who helped locate traditional masons and building communities in the corners of Goa. Thanks to you, I found a treasure of information!

Mason **SEQUEIRA Bernardo** (1954-2018) for your time, patience and interest in explaining the details of Goa's earth building craft. You were such a resource!

AFONSO Lionel, **D'SILVA Ninoshka**, and **RODRIGUES Chevon** for referencing, and gathering bits of research information, while I was not in Goa.

Those who helped with initial preparations before my trip to Portugal: **BUSTARRET Gil**, **KAMATH Harsh** and **PATO Ana**, for sharing literary resources, and advising on places and institutions to visit. **BARON Julien**, Aunt, **CARVALHO Judith**, **LE SEIGNEUR DUCCIO Adrien**, **PATO Ana**; **RAKOTOMAMONJY Bakonirina** (CRAterre); Dada, **RODRIGUES Antonio**; and **SCHENCK Annabel** for sharing your contacts, and putting me in touch with concerned people in Portugal.

Joana and Simão (Lisbon), and **TEIXEIRA Tania and André** (Montemor-o-Novo) for welcoming me into your homes. **VAZ Ana, Xavier and family** for hosting me in Lisbon with such warmth. **NOEL Stéphanie** for opening your doors and sharing your house in Mourão, where I spent most of my stay in Portugal. Thank you to each of you for making feel at home.

LUZ Carla (Architect, Municipality of Mourão), you have been such a bunch of help, right from Portuguese to English translations, putting me in touch with concerned people, and verifying facts as I was writing my dissertation. Thank you for being the point of contact I could count on!

Mason-Sailor **BAPTISTA Joaquim** for the numerous hours you spent with me during my stay in Portugal, explaining details of the region's earth constructions. Thank you for being patient as the matter was being translated, and documented as you spoke. Was lucky to have been put in touch with you!

CAMBRAIA Rui (Journalist, Serpa), **LUZ BAÇÃO Joaquim**, **MATALOTO Rui** (Archaeologist, Redondo), **CARVALHO António** (Archaeologist, Alcácer do Sal), **NUNO Tomás**, **SOUSA Filipe** (ADC Moura), **RIBEIRO Arlinda**, **VAZ Xavier**, and **VIDIGAL João and family**, for assisting me to locate resource persons and buildings in Portugal, accompanying me on site visits, translating from English to Portuguese / French, and providing your inputs. I wouldn't have been able to amass the mass of information I did, if not for you. I am indebted!

Architects **ESTORNINHO Paula**, **FARIA Paulina** (FCT, Universidade NOVA de Lisboa), **FERNANDES Maria** (DGCP), **LOURENÇO Clara** (ADC Moura), **MESTRE Victor**, **MENDES Miguel**, **PEREIRA Catarina**, **RAPOSO Milena**, **SILVEIRA Angelo** (DGCP), and **TEIXEIRA Tania**. Thank you for making time, and sharing your inputs on my project.

MASCARENHAS Alexander and **ALFONSO Carlos** for being a helping hand, sharing information, references, contacts, checking on me, and making sure I was okay. Thank you!

For contributing to the terminologies and vocabulary used in this project with regards to earth buildings: **NAIK Saili** and **GOANKAR Akash** (Konkani), **LUZ Carla** (Portuguese), **KEABLE Rowland** (EBUKI) (English). It brought clarity to my writing.

RODRIGUES Chevon for editing most of the photos used in this project. **ALMEIDA Benson**, **ALMEIDA Rylan**, **D'SILVA Krenza**, **D'SOUZA Sheldon**, **FERNANDES Esther**, **FONSECA Sheldon**, **PEREIRA Rebecca**, **PEREIRA Samantha**, **RODRIGUES Chevon**, and **VEDRINE Bénédicte** for entering my findings and hand-written notes onto the computer, as my eyes decided to play tricks on me, and I could use the computer only sparingly. **D'SOUZA Sheldon**, **GURUSAMY Kaviya**, **PAUL Rosie**, and **TAVERNIER Sarah** for assisting with the layout. **GALLIOT Emy**, **MORTAMET Alice**, **PEOCH Margot**, **SCHENCK Annabel**, **STERN Emmanuel**, **TAVERNIER Sarah**, **TRABAUD Vincent**, **VEDRINE Bénédicte**, and **VITON Jean** for the English to French translations at the eleventh hour! In whichever part of the world you are, thank you for reaching out. Friends in need, friends indeed!

Special thanks to **VEDRINE Bénédicte** for the countless times you were there. I can't thank you enough! **TAVERNIER Sarah**, you jumped to my help even before I knew I needed it. Glad to have you! **RAKOTOMAMONJY Bakonirina** and **GANDREAU David** for being available for necessary paperwork with regards to my visas, taking my health issues into consideration, and organising my submission on a convenient date. I am grateful.

Finally, a big thank you to all the **inhabitants and masons in Goa and Portugal, who shared your inputs**. They were the most valuable of all!

**CETTE ÉTUDE EST ÉCRIT EN ANGLAIS.
LES PARTIES SUIVANTES SONT ÉCRIT / TRADUITES EN FRANÇAIS.**

DÉCLARATION D'INTENTION DU MÉMOIRE (en française uniquement)

SOMMAIRE

I. INTRODUCTION

1. Contexte

- 1.1. Goa et le Portugal: Une histoire partagée
- 1.2. Architecture (en terre) à Goa et au Portugal: Un patrimoine partagé (?)

IV. CONCLUSION

9. Étude comparatif — Goa et Alentejo

- 9.1. Cultures constructives locales
- 9.2. Approches de conservation

10. Conclusion

ANNEXES

Annexes — Goa

Modèle d'enquêtes

Annexes — Portugal

Modèle d'enquêtes

**THIS STUDY IS WRITTEN IN ENGLISH.
THE FOLLOWING SECTIONS ARE TRANSLATED TO FRENCH.**

DÉCLARATION OF INTENT (in French only)

CONTENTS

I. INTRODUCTION

1. Context

- 1.1. Goa and Portugal: A shared history
- 1.2. Architecture (en terre) à Goa et au Portugal: A shared heritage (?)

IV. CONCLUSION

9. Étude comparatif — Goa et Alentejo

- 9.1. Local construction cultures
- 9.2. Conservation approaches

10. Conclusion

ANNEXES

Annexes — Goa

Case-study template

Annexes — Portugal

Case-study template

TABLE DE MATIÈRES / TABLE OF CONTENTS

ACKNOWLEDGEMENTS	7
<i>(En français / in French)</i>	13
Déclaration d'intention du mémoire de.....	14
Sommaire.....	16
I. INTRODUCTION	18
1. CONTEXTE	18
1.1. GOA ET LE PORTUGAL: UN PATRIMOINE PARTAGÉ.....	18
1.2. ARCHITECTURE (EN TERRE) À GOA ET AU PORTUGAL: UN PATRIMOINE PARTAGÉ.....	19
2. METHODOLOGIE	20
2.1. DEPUIS LE PLAN PRÉLIMINAIRE.....	20
2.1. MÉTHODOLOGIE D'ENQUÊTE PUIS ANALYSES.....	22
IV. CONCLUSION	26
9. ETUDE COMPARATIVE — GOA ET ALENTEJO	26
9.1. CULTURES CONSTRUCTIVES LOCALES.....	26
9.2. APPROCHES DE CONSERVATION.....	38
10. CONCLUSION	39
<i>(En anglais / in English)</i>	41
I. INTRODUCTION	43
1. CONTEXT	44
1.1. GOA AND PORTUGAL: A SHARED HISTORY.....	44
1.2. (EARTHEN) ARCHITECTURE OF GOA AND PORTUGAL: A SHARED HERITAGE.....	45
2. METHODOLOGY	46
2.2. SINCE THE PRELIMINARY PLAN.....	46
2.3. SURVEY METHODOLOGY TO ANALYSES.....	48
II. GOA — INDIA	53
3. INTRODUCTION — GOA	54
3.1. GEOGRAPHY.....	54
3.2. GEOLOGY.....	58
3.2.1. LITHOLOGY.....	58
3.2.2. PEDOLOGY.....	60
3.2.3. SEISMIC RISK.....	62
3.3. CLIMATE.....	63
3.4. EARLY GOANS AND HISTORY OF MIGRATION.....	64
3.5. BELIEFS AND PRACTICES.....	67
3.6. EARTH CONSTRUCTION TECHNIQUES IN GOA.....	71
3.7. EVOLUTION FROM THE PRE-PORTUGUESE TO THE INDO-PORTUGUESE HOUSE.....	76
4. SURVEY — GOA	82
4.1. REGIONS SELECTED FOR STUDY.....	82
4.2. LOCATIONS OF BUILDINGS SURVEYED AND CASE-STUDIES.....	83
5. RESEARCH REPORT — GOA	148
5.1. ANALYSES OF LOCAL BUILDING CULTURES — GOA.....	148
5.1.1. 'REGION A' — SALCETE, SOUTH GOA.....	148
5.1.2. 'REGION B' — SANGUEM, SOUTH GOA.....	153
5.1.3. 'REGION C' — PERNEM, NORTH GOA.....	155
5.2. CONSTRUCTION DETAILS — GOA.....	157
5.2.1. SOILS, CONSTRUCTION TECHNIQUES AND BUILDING TYPOLOGY.....	157
5.2.2. ARCHITECTURAL ASPECTS.....	159
5.2.3. MORTARS, PLASTERS, RENDERS, PIGMENTS AND/OR PAINTS.....	174
5.3. CONSERVATION APPROACHES — GOA.....	176
5.3.1. DAMAGES INCURRED, PROBLEMS, AND CHALLENGES FACED.....	176
5.3.2. MAINTENANCE AND REPAIRS.....	178
5.3.3. FUTURE PLANS.....	182

III. ALENTEJO — PORTUGAL.....	185
6. INTRODUCTION — ALENTEJO.....	186
6.1. GEOGRAPHY.....	186
6.2. GEOLOGY.....	188
6.2.1. LITHOLOGY.....	188
6.2.2. PEDOLOGY.....	189
6.2.3. SEISMIC RISK.....	190
6.3. CLIMATE.....	191
6.4. EARTHEN CONSTRUCTION TECHNIQUES IN PORTUGAL.....	192
6.5. HISTORY OF EARTHEN CONSTRUCTIONS IN PORTUGAL.....	194
6.6. RURAL ARCHITECTURE OF ALENTEJO.....	196
7. SURVEY — ALENTEJO.....	200
7.1. REGIONS SELECTED FOR STUDY.....	200
7.2. LOCATIONS OF BUILDINGS SURVEYED AND CASE-STUDIES.....	201
7.3. PHOTO DOCUMENTATION: SURVEYS IN 2000 AND 2018.....	250
8. RESEARCH REPORT — ALENTEJO.....	256
8.1. ANALYSES OF LOCAL BUILDING CULTURES — ALENTEJO.....	256
8.2. CONSTRUCTION DETAILS — ALENTEJO.....	266
8.2.1. SOILS, CONSTRUCTION TECHNIQUES AND BUILDING TYPOLOGY.....	266
8.2.2. ARCHITECTURAL ASPECTS — ALENTEJO.....	269
8.2.3. MORTARS, PLASTERS, RENDERS, PIGMENTS AND/OR PAINTS.....	271
8.3. CONSERVATION APPROACHES — ALENTEJO.....	274
8.3.1. DAMAGES INCURRED, PROBLEMS AND CHALLENGES FACED.....	274
8.3.2. MAINTENANCE AND REPAIRS.....	275
8.3.3. FUTURE PLANS.....	276
IV. CONCLUSION.....	277
9. COMPARATIVE ANALYSES — GOA AND ALENTEJO.....	278
9.1. LOCAL BUILDING CULTURES.....	278
9.2. CONSERVATION APPROACHES.....	290
10. CONCLUSION.....	291

ANNEXES — GOA

CLIMATE GRAPHS — GOA

SOIL LEGEND — GOA

SURVEY TEMPLATE — GOA (IN FRENCH)

SURVEY TEMPLAE — GOA (IN ENGLISH)

ANNEXES — PORTUGAL

CLIMATE GRAPHS — PORTUGAL

SURVEY TEMPLATE — GOA (IN FRENCH)

SURVEY TEMPLATE — GOA (IN ENGLISH)

RESEARCH REPORT 'TAIPA HOUSES IN ALENTEJO' (DOCUMENTS SUBMITTED TO FUNDAÇÃO ORIENTE)

ARTICLE IN THE LOCAL NEWSPAPER, 'DÍARIO DO ALENTEJO' ABOUT MY RESEARCH

MY POST ON THE FUNDAÇÃO ORIENTE BLOG ABOUT MY EXPERIENCE IN PORTUGAL

Table of images

Bibliography

(En français / in French)

**Comparaison de l'architecture vernaculaire en terre
de Goa (ancienne colonie portugaise en Inde) et de l'Alentejo (Portugal):
Cultures constructives locales et approches de conservation**

Déclaration d'intention du mémoire de DSA - Architecture de Terre et Patrimoine, 2016-2018 L'ÉCOLE NATIONALE SUPÉRIEURE D'ARCHITECTURE DE GRENOBLE

1. SUJET

Comparaison de l'architecture vernaculaire en terre de Goa (ancienne colonie portugaise en Inde) et de l'Alentejo (Portugal): Cultures constructives locales et approches de conservation.

2. CONTEXTE

L'état de Goa est une ancienne colonie portugaise. Les portugais y étaient de 1510 à 1961. Bien que Goa ait conservé une grande partie de sa culture autochtone, l'état a été également influencé par la culture portugaise : la cuisine, la religion, la politique, l'art, l'architecture, etc. Cela fait plus de 50 ans que Goa a pris son indépendance du Portugal, et est devenu une partie de l'Inde sous forme d'état (l'équivalent des régions françaises), mais la culture de cet état reste un mélange de culture indienne et portugaise qui est communément appelé la culture «Indo-portugaise». Si la culture «Indo-portugaise» revêt de nombreux aspects, l'architecture «Indo-portugaise» en séduit beaucoup, notamment de belles demeures appelés «maisons portugaises».

A Goa, il existe plusieurs maisons en terre : des maisons du territoire et les maisons qui sont évidemment influencées par l'architecture portugaise. La deuxième catégorie des maisons incorpore les styles d'architecture de Goa et du Portugal, et ils sont devenus lentement l'identité du paysage architectural de Goa. Ces maisons ont souvent leur particularité en style, design, et grandeur. En fait, Goa est un des rares lieux en Inde, et bien sûr dans le monde, où l'architecture «Indo-portugaise» existe.



Image 1 and Image 2: Les maisons au Portugal. [Source: olhares.sapo.pt, oldportuguesestuff.com]



Image 3 and Image 4: Les maisons à Goa. [Source: dsourc.in, lokaso.in]



Image 5: Mur en terre à Goa. Image 6: Mur en terre en Alentejo.

[Source: Associação Centro da Terra. *Arquitectura de Terra em Portugal. Earth Architecture in Portugal*, 2005 (Image vi)]

Cela m'a poussé à étudier l'architecture vernaculaire en terre construite à la fois à Goa et au Portugal, pendant l'époque où Goa était un territoire portugais. Une brève recherche initiale a révélé que, même s'il existe des maisons en terre presque partout à Goa et au Portugal, celles de la région de l'Alentejo au Portugal ressemblent à celles de Goa de par leurs murs en terre qui présentent des couches horizontales. Afin de tracer un périmètre pour cette étude, elle se concentre sur une comparaison de ces deux groupes de maisons en terre, c-à-d à Goa et en Alentejo.

3. QUESTIONS DE RECHERCHE

- 1) Quel pourcentage de similarité existe entre les cultures constructives en terre à Goa et au Portugal ?
- 2) L'architecture de terre vernaculaire portugaise a influencé celle de Goa et vice-versa pendant les 451 ans de règne portugais à Goa de 1510 à 1961?
- 3) Comment ces bâtiments ont-ils évolué pendant des années? Quelles sont les techniques (anciennes et modernes) qui étaient utilisées pour entretenir et conserver les bâtiments en terre à Goa et au Portugal?

4. HYPOTHÈSE

Je fais l'hypothèse que en rassemblant des informations qui enrichissent notre compréhension des cultures constructives locales et des approches de conservation dans les deux régions, nous contribuons à faciliter l'entretien de ces bâtiments en terre aujourd'hui.

En m'engageant dans des projets de conservation du patrimoine à Goa, où j'ai grandi, j'ai constaté que diverses études parlent de l'influence portugaise sur les bâtiments publics, les églises et les demeures de Goa. Cependant, j'ai réalisé que la documentation disponible laissait un vide qui ne permettait pas une conservation globale du patrimoine architectural de Goa.

- 1) Il y a peu de documentation sur les matériaux et les techniques utilisés pour construire ces structures, ainsi que sur les méthodes utilisées pour les entretenir.
- 2) Ce qui est resté en grande partie ignoré, ce sont les maisons des habitants, dont beaucoup sont construites en terre — et sont en train de disparaître rapidement.
- 3) Alors que de nombreux échanges culturels, notamment entre Goa et le Portugal, portent sur l'architecture «Indo-portugaise», la terre comme matériau de construction, n'a guère retenu l'attention — même si elle fait partie intégrante du patrimoine et que les maisons en terre constituent une grande partie de son paysage architectural.

Malheureusement aujourd'hui, le patrimoine architectural en terre à Goa et aussi au Portugal reçoivent moins d'attention et est en danger à cause de nombreuses raisons. Bien qu'il y a des maisons en bon état, il y a de plus et plus de maisons qui sont détruites, dégradés ou qui sont en état de dégradation.

A Goa, comme plusieurs régions dans le monde, les maisons en terre sont associées à la pauvreté. Du coup avec l'augmentation du statut socio-économique des habitants, de plus et plus de gens choisissent de casser les maisons en terre et de les remplacer avec des maisons en pierres-latérite et le ciment. Pendant mes études et voyages en Inde et Europe, j'ai remarqué que dans plusieurs régions, comme à Goa et au Portugal, il y a des habitants qui choisissent de rénover les maisons en ajoutant des bains modernes, des carreaux céramiques, de l'enduit en ciment, etc. Mais en analysant, il devient de plus et plus évident que les dégâts sont sous forme de remonté capillaire, d'humidité dans les murs, etc. et commence juste quelques années après la rénovation. Il montre qu'il nous manque les bonnes connaissances au niveau théorique et pratique pour faire l'entretien, et/ou la conservation et/ou la restauration et/ou la rénovation de ces maisons dans le but d'assurer une meilleur longévité et aussi une amélioration de l'esthétique.

5. BUTS

Les principaux objectifs de cette étude sont:

- 1) Comprendre si l'architecture de terre vernaculaire portugaise a influencé celle de Goa et/ou vice-versa, pendant les 451 ans de règne portugais à Goa de 1510 à 1961.
- 2) Rassembler une compréhension des cultures constructives locales et les approches de conservation dans les deux régions, avec une intention que cette information faciliterait l'entretien de ces bâtiments en terre aujourd'hui.

6. SOUTENANCE: Janvier, 2020.

Sommaire

Hommage et remerciements

Table de matières

Déclaration d'intention

Sommaire

I. INTRODUCTION

1. Contexte

- 1.1. Goa et le Portugal : Une histoire partagée
- 1.2. Architecture (en terre) à Goa et au Portugal : Un patrimoine partagé (?)

2. Méthodologie

- 2.1. Depuis le plan préliminaire...
 - 2.1.1. Séjours à Goa et au Portugal
 - 2.1.2. Sélection des structures
 - 2.1.3. Autres défis
- 2.2. Méthodologie d'enquête puis analyses...
 - 2.2.1. Format des études de cas
 - 2.2.2. Analyses et conclusion

II. GOA – INDE

3. Introduction — Goa

- 3.1. Géographie
- 3.2. Géologie:
 - 3.2.1. Géologie
 - 3.2.2. Pédologie
 - 3.2.3. Risque sismique
- 3.3. Climat
- 3.4. Les premiers goanais et l'histoire de la migration
- 3.5. Croyances et pratiques
- 3.6. Techniques constructives en terre à Goa
- 3.7. Évolution de la maison pré-Portugaise à la maison Indo-Portugaise

4. Études de cas — Goa

5. Rapport de la recherche — Goa

- 5.1. Analyses des cultures constructives locales
 - 5.1.1. 'Région A' — Salcete, South Goa
 - 5.1.2. 'Région B' — Sanguem, South Goa
 - 5.1.3. 'Région C' — Pernem, North Goa
- 5.2. Approches des conservations
 - 5.2.1. Dégâts, problèmes et défis relevés
 - 5.2.2. Entretien et Réparations
- 5.3. Considérations finales — Goa
 - 5.3.1. Sols, techniques de construction, typologie
 - 5.3.2. Détails des constructions
 - 5.3.3. Mortiers, enduits, pigments et/ou peintures

III. ALENTEJO — PORTUGAL

6. Introduction — Alentejo

- 6.1. Géographie
- 6.2. Géologie:
 - 6.2.1. Géologie
 - 6.2.2. Pédologie
 - 6.2.3. Risque sismique
- 6.3. Climat
- 6.4. Techniques constructives en terre au Portugal
- 6.5. Histoire de la construction en terre au Portugal
- 6.6. Architecture rurale à Alentejo

7. Études de cas — Alentejo

8. Rapport de la recherche — Alentejo

- 8.1. Analyses des cultures constructives locales
 - 8.1.1. 'Région A' — Reguengos de Monsaraz, Évora
 - 8.1.2. 'Région B' — Redondo, Évora
 - 8.1.3. 'Région C' — Mourão, Évora
 - 8.1.4. 'Région D' — Moura, Beja
 - 8.1.5. 'Région E' — Serpa, Beja
- 8.2. Approches des conservations
 - 8.2.1. Dégâts, problèmes et défis relevés
 - 8.2.2. Entretien et réparations
- 8.3. Considérations finales — Goa
 - 8.3.1. Sols, techniques de construction, typologie
 - 8.3.2. Détails des constructions
 - 8.3.3. Mortiers, enduits, pigments et/ou peintures

IV. CONCLUSION

9. Étude comparatif — Goa et Alentejo

- 9.1. Cultures constructives locales
- 9.2. Approches de conservation

10. Conclusion

ANNEXES

Annexes — Goa

Graphiques du climat — Goa
Liste des différents types de sols de Goa
Modèle d'enquêtes — Goa (en français)
Modèle d'enquêtes — Goa (en anglais)

Annexes — Portugal

Graphiques du climat — Portugal
Modèle d'enquêtes — Portugal (en français)
Modèle d'enquêtes — Portugal (en anglais)
Rapport de recherche « Taipa houses in Alentejo » (Documents remis à la Fundação Oriente)
Publication dans un journal local « Diário do Alentejo » de mes recherches
Article de mes expériences au Portugal sur le blog de Fundação Oriente

Table des illustrations

Bibliographie

I. INTRODUCTION

1. CONTEXTE

1.1. GOA ET LE PORTUGAL: UN PATRIMOINE PARTAGÉ

Le Portugal a été le premier État-nation en Europe à établir un empire colonial d'outre-mer et il détient (avec l'Espagne) le record du premier empire mondial moderne.^{[1][2]} L'empire portugais (1415-1999) était constitué de terres qui s'étendaient à travers l'Amérique, l'Afrique et l'Asie.^[3] L'un des plus anciens territoires portugais occupés (après ceux d'Afrique) était Goa (Inde).

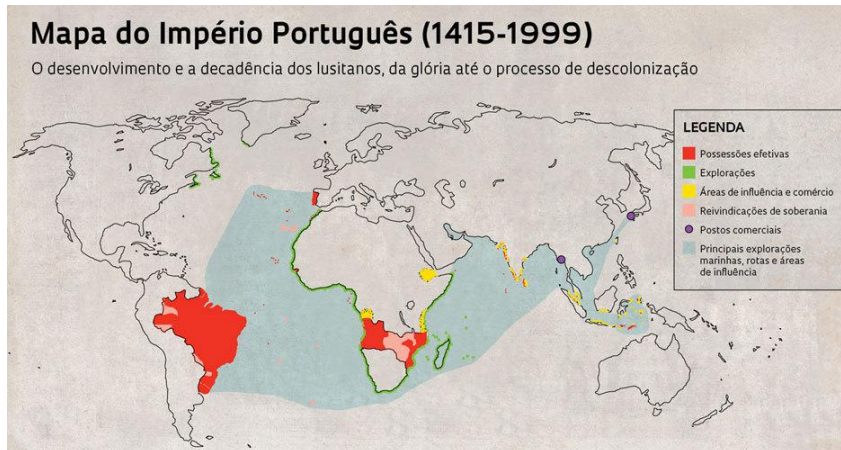

Image 7: Carte des colonies portugaises.
[Source: www.mapsontheweb.zoom-maps.com]

Les Portugais ont régné sur Goa pendant 451 ans (1510-1961). Dans diverses archives portugaises, Goa est désignée par les termes «Estado da Índia»^[4] (État de l'Inde), «Estado Português da Índia» (État portugais de l'Inde), ou «Índia Portuguesa» (Inde portugaise).

Après le départ des Portugais, Goa faisait partie du territoire de l'Union de Goa, de Daman et de Diu. Un référendum connu sous le nom de sondage d'opinion a eu lieu en 1967, le résultat était alors favorable à ce que Goa devienne une entité indépendante.^{[5][6]} Le 30 mai 1987, Goa a obtenu le statut d'État distinct.^[7] En dépit, jusqu'à aujourd'hui, nombreux sont ceux qui citent les changements liés à l'abandon du Portugal et à l'annexion de Goa à l'Inde.^[8] Ainsi ce que certains appellent la «libération de Goa» est aussi appelé l'«invasion de Goa» par d'autres.

Goa est actuellement divisé en 12 «talukas» dans le système politique indien. Quatre d'entre elles forment les anciennes conquêtes ou «Conquistas de Velhas», qui font référence aux régions conquises par les Portugais au XVe siècle. Les autres ont été capturés plus tard et forment les nouvelles conquêtes ou «Novas Conquistas». Les anciennes conquêtes comprennent Tiswadi (reprise en 1510), Bardez, Mormugao et Salcette (1543). Les nouvelles conquêtes comprennent Pernem, Bicholim, Satari, (1788) Ponda, Dharbandora, Sanguem, Quepem et Canacona (1763).^{[9][10]} Naturellement, les anciennes conquêtes affichent une influence portugaise plus forte que les nouvelles conquêtes.

Le Portugal - et ses colonies - ont influencé la cuisine, l'art, l'architecture, la musique, la religion, l'éducation, les politiques et l'administration de l'état de Goa. Cela se voit à la fois dans les anciennes et les nouvelles conquêtes. Cependant, tout en s'imprégnant de la culture portugaise, Goa a également conservé sa culture autochtone. Encore

¹ Page, *Colonialism: An International Social, Cultural and Political Encyclopedia Volume 1*, p.481

² Phillips, *A Concise History of Spain*, p.134

³ Brockey, *Portuguese Colonial Cities in the Early Modern World*, p.xv

⁴ Issar, *Goa Dourada*, p.169

⁵ Rangel-Ribeiro, ed., *Goa Aparanta – Land Beyond the End*, p.56

⁶ Gomes, *A Concise History of Goa*, p.329-331

⁷ www.goa.gov.in

⁸ Lobo, *FREE GOA from INDIAN Invasion & it's Continued Illegal Occupation against UN Resolution*, »

www.change.org/p/prevent-genocide-of-goan-christians-by-communal-corrupt-illegal-indian-administration-in-go-a-former-portuguese-colony-where-goans-are-forced-to-immigrate-from-their-own-motherland-to-other-countries?use_react=false (accessed September 11, 2019)

⁹ Pereira, *Ethnography of Goa, Daman and Diu*, p.11

¹⁰ Khedekar, *Goa: Land, Life and Legacy*, p.4

aujourd'hui, la culture de Goa continue de présenter un mélange unique d'éléments indiens et portugais, mieux décrits par la culture «Indo-portugaise».^{[11][12]}



Image 8: Vieilles et nouvelles conquêtes, Goa.

[Source: Hall, 1992, p.14]

Le Portugal et Goa, y compris l'ensemble de l'Inde, continuent d'entretenir de bonnes relations. Diverses organisations telles que la Fundação Oriente, la Camões Instituto da Cooperação e da Língua et la Société lusophone de sont basées à Goa et promeuvent la langue et la culture portugaises. De même au Portugal, des organisations telles que la Casa de Goa, la communauté hindoue du Portugal, l'association culturelle des amis de Goa «Damão E Diu» et l'Associação Recreativa e Cultural Indo-Portuguesa propagent la culture goanaise et indienne au Portugal.

1.2. ARCHITECTURE (EN TERRE) À GOA ET AU PORTUGAL: UN PATRIMOINE PARTAGÉ...

Diverses études et théories existent sur l'étendue de l'influence portugaise sur la culture de Goa. L'architecture, en particulier celle des églises et des maisons souvent désignées comme «maisons portugaises», «maisons indo-portugaises», «maisons indo-européennes», «maisons patrimoniales de Goa» ou simplement «maisons de Goa». Alors qu'elles font souvent référence aux grandes maisons « bourgeoises », il reste moins de recherches sur les plus petites habitations appartenant aux classes moyenne et inférieure. Un autre aspect très important, qui est également moins étudié, est celui des matériaux et des technologies utilisés pour construire les différentes structures.

On remarque une ressemblance frappante d'architecture domestique parmi les maisons construites en terre par couches de terre, visibles à la fois à Goa et en particulier dans la région de l'Alentejo au Portugal. À Goa, la plupart des maisons sont enduites de plâtre et il est donc difficile d'observer les matériaux et les techniques avec lesquels ces maisons ont été construites. Afin de relier et de trouver des mesures qui préserveraient ce patrimoine partagé à Goa et au Portugal, les **but**s de cette étude sont:

- 1) **Comprendre si l'architecture de terre vernaculaire portugaise a influencé celle de Goa et/ou vice-versa, pendant les 451 ans de règne portugais à Goa de 1510 à 1961.**
- 2) **Rassembler une compréhension des cultures constructives locales et les approches de conservation dans les deux régions, avec une intention que cette information faciliterait l'entretien de ces bâtiments en terre aujourd'hui.**

¹¹ Borges and Feldmann, eds., *Goa and Portugal: Their Cultural Links*, p.41-47

¹² Rangel-Ribeiro, ed., *Goa Aparanta – Land Beyond the End*, p.201

2. METHODOLOGIE

2.1. DEPUIS LE PLAN PRÉLIMINAIRE...

Au cours de mes recherches initiales, j'ai retrouvé un mémoire antérieure de DPEA-Terre: « Le Pisé d'Alentejo » de l'architecte Mariana Correia (2000), qui a ensuite été traduit en portugais et en anglais et publié dans un livre: « Taipa no Alentejo. Rammed Earth in Alentejo » (Lisbonne, 2007). Cette étude était directement liée à mon sujet, « Comparaison de l'architecture vernaculaire en terre de Goa (ancienne colonie portugaise en Inde) et de l'Alentejo (Portugal): Cultures de construction locales et approches de conservation ». Donc, en consultant mes professeurs et Mariana, j'ai décidé de suivre « Taipa no Alentejo. Rammed Earth in Alentejo » (Lisbonne, 2007), comme base pour mes recherches.

Alors que le mémoire de Mariana se concentrait sur les cultures locales de construction, la mienne comprenait également des approches de conservation.

Ma méthodologie de recherche, c'est-à-dire le format du contenu, y compris le format des études de cas, a été empruntée à Mariana. La méthodologie a été suivie dans les deux régions, Alentejo et Goa. Cela a été fait afin de maintenir l'uniformité dans le type de données collectées dans les deux régions, et ainsi rendre les comparaisons entre l'Alentejo et Goa réalisables.

Dans mon étude, pour la partie sur l'Alentejo, le contenu, y compris les études de cas, a été dérivé de l'étude de Mariana et revisité par moi-même. J'y ai ajouté une nouvelle catégorie, «Approches de conservation» dans chaque étude de cas. La partie sur Goa a été ma contribution.

Le texte édité, réécrit et / ou revisité par moi-même sur la base du travail de l'architecte Mariana Correia est indiqué en couleur brune, et / ou avec la mention « Réécrit / revisité par Chenelle Rodrigues, basé sur le travail de Mariana Correia («Le Pisé d'Alentejo », 2000; «Taipa no Alentejo. Rammed Earth in Alentejo», 2007). »

La méthodologie adoptée pour ma recherche, «Comparaison de l'architecture en terre vernaculaire de Goa (ancienne colonie portugaise en Inde) et d'Alentejo (Portugal) : Cultures de construction locales et approches de conservation» est élaboré dans les parties suivantes:

- Depuis le plan préliminaire...
 - Séjours à Goa et au Portugal
 - Sélection des structures
 - Autres défis
- Méthodologie d'enquête puis analyses...
 - Format des études de cas
 - Analyses et conclusion

2.1.1. SÉJOURS À GOA ET AU PORTUGAL

Pendant la durée de cette recherche, soit entre janvier 2018 et janvier 2020, j'ai passé environ un an à Goa et deux mois au Portugal.

Je suis née et j'ai grandi à Goa, et tout en menant ces recherches, j'étais basée dans mon village natal, Colva, situé dans le sud de Goa. Je suis évidemment bien liée à la culture de Goa et au fil des années, j'ai visité des musées, des expositions, j'ai assisté à des séminaires et des ateliers, rencontré des professionnels engagés dans des projets d'architecture et de patrimoine, etc. Tous ces facteurs ont constitué la base de cette recherche.

Pendant mon séjour à Goa, j'ai passé quelques mois à faire des recherches préliminaires dans les bibliothèques, qui ont une vaste collection de livres, en particulier sur l'histoire de Goa et du Portugal, et sur l'architecture.

- Bibliothèque du district du Dr Francisco Luis Gomes, Navelim.
- Bibliothèque centrale d'État Krishnadas Shama Goa, Panaji.
- Bibliothèque Goa College of Architecture, Panaji.

Plusieurs maisons en terre ont été visitées et des maçons, des constructeurs propriétaires, des laïcs, etc. ont été interrogés. Parmi les professionnels liés à l'architecture et au patrimoine à Goa, les architectes Tallulah D'Silva (connus

pour ses éco-conceptions), Noah Fernandes (conservation du patrimoine), Hyacinth Pinto (constructions en terre), Ketak Nachinolkar (conservation du patrimoine), entre autres, ont été contactés.

Pour ma visite au Portugal, j'ai reçu la bourse Fundação Oriente, qui soutient la recherche scientifique entre le Portugal et les pays de l'Est. Lors de ma visite au Portugal, j'étais principalement basée dans le village de Mourão dans le district d'Évora de l'Alentejo. Les deux mois que j'ai passés au Portugal ont été plutôt intenses, car j'y ai visité plusieurs musées, des sites du patrimoine et maisons en terre, et rencontré des architectes et d'autres professionnels impliqués dans l'architecture et le patrimoine, en particulier les bâtiments en terre. Un rapport détaillé de mon itinéraire a été soumis à la «Fundação Oriente»; il est joint en annexe.

À Goa et au Portugal, j'ai voyagé sur des routes moins accessibles pour atteindre certaines maisons, ce qui m'a permis de découvrir des endroits reculés de ma propre région, Goa, ainsi qu'au Portugal. Sans la réalisation de cette étude, je n'aurais probablement pas eu l'occasion d'en être témoin.

2.1.2. SÉLECTION DES STRUCTURES

Divers facteurs ont été pris en considération lors de la sélection des structures en terre pour cette étude.

- 1) À Goa, les zones sélectionnées étaient (a) Salcete (sud de Goa) correspondant à la « Old Conquest », la première conquête. Elle correspond aux zones occupées par les Portugais au cours des premières années de leur arrivée et qui ont été plus influencées par les Portugais que les autres parties de Goa, (b) Sanguem (Sud de Goa), où il est possible de voir les traditions indigènes de Goa encore bien conservées par les habitants, (c) Pernem (Nord de Goa) car les meilleurs maçons de Goa étaient connus pour être originaires de cette région et il serait intéressant d'analyser leurs maisons construites par eux-mêmes. Bien que ces maçons aient traditionnellement construit avec de la terre, ils ont évolué avec le temps et ont construit des bâtiments en latérite et terre ou en latérite et ciment.

En Alentejo, l'enquête a été menée principalement dans la partie orientale de la région en raison de la concentration de constructions en pisé.

- 2) Alors que les structures en Alentejo ont été choisies sur la base de l'étude de Mariana, il a été noté que de nombreux bâtiments en pisé en Alentejo avaient des murs sans plâtre, ce qui permettait d'étudier les matériaux de construction et la typologie des bâtiments utilisés. Cependant, ce n'était pas le cas à Goa, où trouver des murs de terre non enduits était un défi. Auparavant, les bâtiments secondaires tels que les dépendances et les abris pour animaux, et les murs arrière de certaines maisons étaient généralement laissés sans plâtre. Cependant, aujourd'hui, bon nombre de ces structures n'existent plus, ou alors les murs arrière sont maintenant enduits. Les murs en plâtre rendent également difficile l'identification des constructions en terre. Ainsi, à Goa, la localisation de bâtiments avec au moins un mur sans enduit était un critère primordial.

Comme je viens de la région de Goa à Salcete, je connaissais certains bâtiments avec des murs sans plâtre. Je me suis aussi renseignée autour de moi.. En ce qui concerne les autres régions de Goa couvertes par cette étude, à savoir Sanguem et Pernem, je les ai visitées en recherchant directement des maisons aux murs sans plâtre.

- 3) Dans les deux régions, il était prioritaire de rencontrer des personnes liées au bâtiment sélectionné. Ceux qui se souviennent de la construction de la maison ou qui ont entendu de telles histoires de leurs parents ou grands-parents, ou qui vivent dans ces maisons depuis de nombreuses années et ont contribué à son entretien. Des informations ont également été recueillies auprès d'autres habitants de la région, qui se souviennent de la construction et de l'entretien de maisons en terre. Cela a permis de ressortir des informations sur les matériaux utilisés, les constructeurs locaux, les techniques de construction, les traditions de construction, les méthodes d'entretien, les croyances et les pratiques associées à ces maisons, etc.

2.1.3. AUTRES DÉFIS

Comme je ne parle pas le portugais et que ne conduis pas, trouver mon chemin dans l'Alentejo était toute une aventure. Cependant, le vrai défi était quand j'avais besoin de localiser les maisons et de parler aux habitants à leur sujet.

Néanmoins, il y avait des habitants de la région qui ont fait preuve d'intérêt pour cette recherche, m'ont véhiculé et ont traduit du portugais vers l'anglais ou du portugais vers le français (vice-versa). J'ai emporté avec moi une copie de la thèse de Mariana, « Le Pisé d'Alentejo », qui a ajouté de la crédibilité lorsque je leur exposais mes recherches. Il m'a aussi été utile lors de mes contacts avec des architectes ou des archéologues. J'ai également choisi de me rapprocher de l'architecte ou de l'archéologue de la commune concernée, qui m'ont souvent aidé lors de visites sur place ou m'ont mis en contact avec quelqu'un qui le ferait.

Grâce à chacun d'eux, cette recherche a été possible. Cependant, dans ces situations, il n'a pas toujours été possible de passer autant de temps dans les maisons sélectionnées de l'Alentejo et de fouiller autant d'informations que j'aurais aimé.

À Goa, étant née et ayant été élevée dans cette région, et ayant moi-même vécu les huit premières années de ma vie dans une maison en terre, je connaissais certaines traditions culturelles associées à ces maisons. Je parlais le Konkani (langue locale de Goa), et j'avais mon propre moyen de locomotion, mon scooter. En cas de longues distances, des voitures d'amis ou de location ont pu être mises à ma disposition. Je connaissais aussi personnellement certains des propriétaires des maisons sélectionnées. Ces facteurs ont grandement facilité mes entretiens avec des habitants locaux.

2.1. MÉTHODOLOGIE D'ENQUÊTE PUIS ANALYSES...

En suivant la méthodologie de l'enquête, deux facteurs principaux ont été pris en compte : (a) rédiger les informations de manière précise et organisée (b) enregistrer les données qui seraient utiles pour de futurs efforts de recherche.

À Goa, seize études de cas ont été menées. J'ai passé quelques heures, parfois jusqu'à une journée entière autour de chaque construction.

Chacune des constructions a été visitée avec Lionel Afonso, un étudiant du Goa College of Architecture, qui a réalisé les plans, les illustrations et les dessins de mesure, selon mes instructions. Lui aussi a passé quelques heures autour de chaque structure, et les a parfois revus s'il en ressentait le besoin.

Pour la région de l'Alentejo, j'avais une liste de 40 maisons en terre examinées par Mariana et j'avais l'intention de visiter environ 15 à 20 d'entre elles. J'ai réussi à visiter 26 maisons et à entrer en contact avec des personnes en relation avec 15 d'entre elles. Cela m'a permis de mettre à jour 15 études de cas réalisées par Mariana en 2000.

Au Portugal, comme mentionné dans la section « Autres défis », j'avais un temps limité et j'ai passé environ une heure autour de chaque construction. J'étais généralement accompagnée d'un architecte, d'un archéologue, d'un professionnel apparenté et / ou d'un habitant local, qui m'a aidé pour la traduction et pour localiser les maisons sélectionnées.

Au cours de cette recherche, deux modèles d'études de cas ont été utilisés. Un format d'étude de cas a été adopté lors de la visite du bâtiment ; il contenait plus de détails. Le deuxième format ne documentait que les informations pertinentes pour cette étude. Ce dernier, le modèle final figure dans cette étude.

2.1.1. FORMAT DES ÉTUDES DE CAS

Au cours de cette recherche, deux modèles d'études de cas ont été utilisés. Un lors de la visite du bâtiment, qui contenait plus de détails. Le second n'a documenté que les informations pertinentes pour cette étude. Ce dernier, le modèle final figure dans cette étude.

Le modèle final a deux versions, une pour Goa et l'autre pour le Portugal, et elles contiennent des variations mineures. Les deux versions sont jointes en annexe.

Les deux modèles contiennent les suivantes catégories et sous-catégories :

A. Numéro de l'étude de cas.

B. Identification.

C. Information du bâtiment: Données chronologiques, Données techniques et Données typologiques.

D. Conservation et longévité: États des lieux, et Entretiens et réparations.

E. Changements principaux depuis 2000 (Portugal uniquement).

A. NUMÉRO DE L'ÉTUDE DE CAS

Chaque étude de cas à Goa était numérotée comme « Enquête no. 1, « Enquête no. 2 », dans l'ordre des bâtiments visités. Seize études de cas ont été menées à Goa.

Dans le cas des études de cas en Alentejo, le numéro d'enquête est suivi d'un autre numéro marqué entre parenthèses. Ce dernier numéro indique le numéro d'étude de cas tel qu'il a été attribué dans les recherches de Mariana. Exemples: « Enquête no. 2 [38] » indique « Enquête no. 2 » dans cette étude et « Enquête no. 38 » dans l'étude de Mariana; « Enquête no. 12 [27] » fait référence à « Enquête no. 12 » dans cette étude, et « Enquête no. 27 » dans l'étude de Mariana. Douze maisons au Portugal ont été documentées pour cette étude.

B. IDENTIFICATION

Dans cette section des études de cas, les sous-thèmes variaient légèrement dans le cas de l'enquête réalisée respectivement à Goa et en Alentejo.

Les détails des études de cas à Goa comprenaient: « District », « Taluka », « Village », « Propriétaire(s) / Locataire(s) », « Nombre d'habitants », « Adresse », « Technique(s) de construction » et « Visité le ».

Dans le cas de l'enquête menée dans l'Alentejo, les régions subtropicales contenues étaient « District », « Municipalité », « Paroisse », « Village le plus proche », « Nom du bâtiment », « Propriétaire(s) », « Adresse », « Directions », « Technique(s) de construction », « Visité le », « Revisité le » et/ou « Rencontré la personne concernée ».

- 1) L'utilisation de « District », « Taluka » et « Village » pour le modèle d'étude de cas pour Goa; et « District », « Municipalité » et « Village le plus proche » pour l'Alentejo devaient permettre de localiser facilement les structures sélectionnées respectivement dans les divisions administratives de Goa et du Portugal. Le sous-point « Paroisse » a été omis dans le cas de Goa parce que les habitants appartiennent à des religions différentes et ne sont pas nécessairement associés à une paroisse, ce qui ne concerne que les catholiques.
- 2) « Propriétaire (s) / Locataire (s) », « Nombre d'habitants » et « Adresse » pour les études de cas à Goa; et « Nom du bâtiment », « Propriétaire (s) », « Adresse » et « Itinéraire » pour ceux du Portugal indiquent les détails adaptés à chacune des régions.

Pour l'enquête de Goa, « locataires » a été noté car certains occupants attendent le statut de propriétaire. Comme expliqué dans le chapitre d'introduction, « Le système 'Ganukari' ou 'Comunidade', la loi « Goa Mundkar Protection from Eviction Act 1975 » permet aux locataires, grâce à la loi de 1975 sur la protection contre les expulsions de Mundkars, de revendiquer légalement la propriété de la maison et de la parcelle de terrain qu'ils occupent, s'ils remplissent les critères prescrits.

Pour les études de cas sur l'Alentejo, « Nom du bâtiment », « Adresse » et « Directions » ont été spécifiés. Dans le cas de la partie sur Goa, seule « Adresse » est mentionnée car les maisons à Goa ont des numéros attribués pour des raisons administratives et n'ont pas toujours de nom. Le numéro de maison facilite la localisation de la maison et son identification.

« Nombre d'habitants » n'a pas été inclus dans l'enquête en Alentejo car la plupart des maisons contenues dans cette étude sont des « montes » c'est-à-dire des maisons isolées au sommet des buttes, habitées uniquement pendant l'été et utilisées pour des raisons agricoles. La maison principale du ou des propriétaires était généralement située dans un village voisin, où tous les membres de la famille vivaient de façon plus régulière. Cette configuration n'a pas permis d'estimer le nombre exact d'habitants. À Goa cependant, la maison principale était généralement utilisée à la fois à des fins résidentielles et agricoles. Les maisons de Goa avaient souvent un grenier pour stocker les matériaux agricoles.

- 3) Les sous-points « Revisité le » ne figurent que dans les études de cas réalisées au Portugal. « Visité le » indique la date à laquelle Mariana a visité le bâtiment en 2000 et « Revisité le » mentionne la date à laquelle j'ai visité le bâtiment en 2018.

Parfois, « Rencontré la personne concernée » a été ajouté. Il s'agissait de cas où la structure a été visitée à une date particulière (mentionnée dans « Revisité le ») et la personne qui a partagé des informations sur le bâtiment a été interrogée un autre jour.

Dans les études de cas où la structure n'existe plus mais où les personnes qui leur sont associées vivent toujours, « Revisité le » a été exclu et « Rencontré la personne concernée » a été inclus.

- 4) Parfois, des mentions telles que « Documenté en 2000 », « Documenté en 2018 », « Calculé en 2000 », « Lors d'une visite en 2000 », « Lors d'une visite en 2018 », 'En 2000', 'en 2018', etc. sont incluses entre parenthèses.

Ceci est fait afin de distinguer clairement les informations enregistrées en 2000 et en 2018, et de donner un sens correct de la chronologie.

Cette section contient quatre images:

Perspective du bâtiment	Image 2: Façade du bâtiment et ses environs	Image 2: Façade du bâtiment et ses environs
Terre utilisée et typologie	Image 3: Gros plan de la terre utilisée dans la construction de la maison.	Image 4: Typologie du bâtiment

C. INFORMATION DU BÂTIMENT

Cette catégorie comprend trois sous-divisions: « Données chronologiques », « Données techniques » et « Données typologiques ». Les puces pour les sous-catégories sont restées presque uniformes dans les enquêtes menées à Goa et au Portugal. Ils incluent:

- 1) Données chronologiques: « Date de construction », « Constructeur », « Usage d'origine », « Usage actuel », « Histoire du bâtiment », « Restaurations et / ou interventions », « Bâtiment utilisé ou pas actuellement », « Bâtiment en risque », « Informations données par », et « Autres information importante ».
- 2) Données techniques: « Soubassement », « Sol », « Contreforts », « Angles », « Ouvertures », « Type de toiture », « Épaisseur des murs extérieurs », « Détails architecturaux exceptionnels », et « Observations ».
- 3) Données typologiques: « Description de la terre utilisée », « Dimensions des couches » / « Dimensions du pisé », « Mortiers », « Enduits, pigments et/ou peintures », et « Caractéristiques particulières ».

« Dimensions des couches » ont été utilisées dans les études de cas sur Goa et la « Dimensions du pisé » a été utilisée pour celles du Portugal, indiquant respectivement la typologie des torchis et des terres battues.

Généralement, quatre dessins figurent dans cette section:

Image 1: Plan de construction. Dans les cas où l'accès à l'intérieur du bâtiment n'était pas possible, un plan de toiture a été établi.	Image 2: Vue aérienne du bâtiment.
Image 3: Vue de façade ou coupe transversale	Image 4: Généralement un détail architectural

Les dessins des études de cas réalisées à Goa ont été réalisés en 2018-2019 par Lionel Afonse, un étudiant du Goa College of Architecture. Ceux de l'enquête menée au Portugal ont été tirés de la recherche de Mariana. Ce dernier dépeint le bâtiment tel qu'il était lorsque Mariana leur a rendu visite en 2000.

De plus, une page entière est dédiée aux images. Elles montrent généralement l'aspect technique du bâtiment et les méthodes de conservation utilisées pour son entretien.

D. CONSERVATION ET LONGÉVITÉ

Cette catégorie comprend deux sous-catégories: « État des lieux » et « Entretien et réparations ». Les détails inclus dans ceux-ci sont restés standard dans les études de cas documentées à Goa ainsi qu'au Portugal. Ils comprennent:

- 1) Estimation de état: « Dégâts / problèmes » et « Observations ».
- 2) Entretien et réparations: Conservation préventive, « Interventions périodiques », « Réparations », « Observations », « Contraintes actuelle » et « Projet futur du bâtiment ».

E. CHANGEMENT MAJEURS DEPUIS 2000 (Portugal uniquement)

Cette catégorie présente ce à quoi le bâtiment ressemblait en 2000 et lors d'une récente visite en 2018. Il est présenté sous forme de tableau et contient quatre images.

En 2000	Image 1	Image 2
En 2018	Image 3	Image 4

Comme indiqué, les images 1 et 2 font le portrait du bâtiment en 2000, et les images 3 et 4 ont été prises en 2018. Les photos prises en 2000, puis en 2018 ont été prises sous des angles similaires pour permettre une comparaison picturale.

Dans tous les tableaux contenant des images, lorsque seulement deux images sont placées sur la page (au lieu de quatre), une bande de papier contenant les deux autres images est insérée par-dessus. La bande de papier peut être retournée permettant de visualiser les quatre images.

2.1.2. ANALYSES ET CONCLUSION

Une analyse a été tirée des «cultures de construction locales» et des « approches de conservation » employées à Goa et à Alentejo, respectivement. Les données recueillies ont servi à effectuer des analyses comparatives des deux régions.

IV. CONCLUSION

9. ETUDE COMPARATIVE — GOA ET ALENTEJO

Selon le but de cette étude, les bâtiments en terre à Goa et à Alentejo sont comparé suivant :

- Les cultures constructives locales
- Les méthodes employées pour la conservation de ces bâtiments

9.1. CULTURES CONSTRUCTIVES LOCALES

<u>GOA</u>	<u>ALENTEJO</u>
<i>*Les maisons étudiées ne sont pas représentatives de l'intégralité des pratiques constructives de Goa, que ce soit en terme de fonctions, de tailles, de conditions, etc. Elles furent sélectionnées car toutes « possédaient au moins un mur sans enduit », critère de l'étude.</i>	
A. FONCTION DU BÂTIMENT	
La plupart des maisons étudiées à Goa sont des résidences privées. La population étant majoritairement agraire, les maisons possèdent bien souvent une double fonction : résidence, et grenier de stockage : de matières premières comme de matériel agricole.	Les maison étudiées dans l'Alentejo sont soit des « Montes » (maisons isolées, situées au sommets de collines, occupées seulement durant l'été et usées a de fin agricoles), soit des étables. Les propriétaires des « Montes » possèdent souvent leur résidence principale dans le village voisin, où la famille habite la majeure partie de l'année.
B. SOLS	
Les sols étudiés à Goa diffèrent complètement de ceux étudiés dans l'Alentejo.	
Les sols utilisés pour les constructions de Goa sont classifiés en trois catégories, selon des critères visuels :	Les sols étudiés dans les constructions en terre du Portugal sont :
<ul style="list-style-type: none">◦ Sol Jaune; contient argile, sable et débris. ('Région A', Salcete — Etudes n° 1, 3a, 3b, 4, 5, 7, 8, 9, 10).◦ Sol Rouge, contient une terre latéritique et des débris. ('Région A' — Etudes n° 2, 6, 11; 'Région B', Sanguem (Neturlim) — Etudes n° 15; 'Région C', Pernem — Etudes n° 14).◦ Sol Jaune-Brune-Rouge, plutôt argileuse que sablonneuse. ('Région B', Sanguem (Salgini) — Etudes n° 12, 13).	<ul style="list-style-type: none">◦ Vx i.e. Sol Rouge ou Jaune méditerranéen, avec schist. ('Région A', Reguengos de Monsaraz — Etudes n° 1[1]; 'Région E', Serpa — 11[25], 12[27]).◦ Pmg i.e. Sol Gris méditerranéen, avec diorites quatzitiques. ('Région A' — Etudes n° 2[38]).◦ Pac+Vcm i.e. Sol Gris méditerranéen, marne, et Sol Rouge ou Jaune méditerranéen. ('Région B', Redondo — Etudes n° 3[9], 5[11]).◦ Sr i.e. Sol Rouge ou Jaune méditerranéen, argileux avec des dépôts. ('Région B' — Etudes n° 4[10]; 'Region D', Moura — 9[18], 10[19]).◦ Px i.e. Sol Gris méditerranéen, avec schist et wackes grises. ('Région C', Mourão — Etudes n° 6[14], 7[39], 8[40] (première couche compactée).

- Ex i.e. Sol Litho, avec schist ou wackes grises. ('Région C' — Etudes n° 8[40] (deuxième couche compactée)).

C. CONTEXTE ET TECHNIQUES CONSTRUCTIVES EN TERRE

Trois méthodes de construction ont été identifiées à Goa, et deux dans l'Alentejo.

Techniques de construction terre identifiées à Goa :

- **Pisé** (appelée '*taip*' en Konkani (langue traditionnelle de Goa)). (Deux études de cas 'Région B' (Salgini) — Etudes n° 12, 13).
- **Briques d'Adobe** (référéncée comme '*box*'). (Deux études de cas : 'Région A' — Etudes n° 4 (gâble et murs des cuisines), 10 (extension)).
- **Bauge** (sans paille) ('*mathe ghor*', qui signifie littéralement 'maison construite en terre'). (Onze études de cas (sur 16): 'Région A' — Etudes n° 1, 2, 3a, 3b, 4, 5, 6, 7, 8, 9, 11; 'Région B' (Neturlim) — Etudes n° 15).

Dans la 'Région A', Salcete, les habitants et/ou les maçons participent à la construction. Tous les habitants, y compris les propriétaire/constructeurs, parlent de la technique de la Bauge (les bâtiment en Adobe étaient des exceptions). Un maçon en particulier, Bernardo Sequeira a été interviewé dans cette région. Il bâtissait en utilisant les trois techniques : Bauge, Adobe, et Terre compactée.

Salcete a été sélectionnée pour cette étude car elle appartient à la région des 'Vieilles Conquêtes', i.e. la région cédée aux Portugais peu de temps après leur arrivée à Goa, entre 1510 et 1543. Le reste de Goa, qui a été conquis entre 1763 et 1788, forme la région appelée la 'Nouvelle Conquête'.^[13] La 'Vieilles Conquêtes' a une influence Portugaise générale plus forte que la 'Nouvelles Conquêtes'. Il en va de même pour les architectures (de terre) locales.^{[14][15][16][17]}

Dans la 'Région B', Sanguem, il est possible - encore aujourd'hui - de trouver des propriétaires qui construisent leur maison avec l'aide du voisinage. On y trouve aussi des maçons. Dans le village de Neturlim, les propriétaires se réfèrent à leur habitation comme '*taip*', qui s'avèrent être des constructions en Bauge. Dans le village de Salgini, les propriétaires/constructeurs relatent que leurs maisons d'autrefois étaient « moulées à la main » ce qui fait aussi référence à la technique de la Bauge. Aujourd'hui, ils ont adopté la technique de la terre compactée.

Techniques de construction terre identifiées dans l'Alentejo:

- **Pisé** (appelée '*taip*' en Portugais). (Les douze études de cas: 'Région A' — Etudes n° 1[1], 2[38]; 'Région B' — 3[9], 4[10], 5[11]; 'Région C' — 6[14], 7[39], 8[40]; 'Région D' — 9[18], 10[19]; 'Région E' — 11[25], 12[27]).
- **Briques d'Adobe** ('*tijolo cru*'). (Trois études de cas : 'Région A' — Survey no. 1[1] (murs intérieurs); 'Région C' — Etudes n° 7[39] (entre les couches, 8[40] (gâbles)).

La plupart des habitants de la région étudiée en Alentejo décrivent la technique de la terre compactée. Certains mentionnent aussi la technique de la brique d'Adobe.

Trois maçons ont été interviewés : Joaquim Antonio Baptista (81 ans), Manuel Lorenço (64 ans), et António Martins Inácio (environ 70 ans). Joaquim and Manuel sont de Mourão ('Région C'), et António vit dans la Vallée Mortos, Serpa ('Région E'). Joaquim et António décrivent principalement la technique de la terre compactée, alors que Manuel nous raconte que lorsqu'il a commencé à travailler dans les années 70, c'était principalement avec la technique de la brique d'Adobe.

L'Alentejo est caractérisée par ses constructions en terre compactée. Cette étude se concentrait principalement sur la partie Est de la région, i.e. le district d'Evora ('Région A', 'Région B', 'Région C') et celui de Beja ('Région D', 'Région E'), à cause de la présence d'une forte concentration de bâti en terre compactée.

¹³ Khedekar, *Goa: Land, Life and Legacy*, p.4

¹⁴ Borges and Feldmann, eds., *Goa and Portugal: Their Cultural Links*, p.41-47

¹⁵ Rangel-Ribeiro, ed., *Goa Aparanta – Land Beyond the End*, p.200-201

¹⁶ Pandit, *Hidden Hands: Master Builders of Goa*, p.100

¹⁷ Silveira, *Lived Heritage, Shared Space: The Courtyard House of Goa*, p.72

Salgini est une communauté forestale dans l'Ouest de Ghats, une zone classifiée UNESCO (Natural) World Heritage Site

Dans la 'Région C', Pernem, la technique de construction terre n'a pas pu être identifiée. Les propriétaires néanmoins, se réfèrent aussi à leur habitat comme 'taip'. Deux maçons interviewés, Bapu Shabi Gadakar et Babuso A. Mandrekar (68 ans). Bapu expliqua la technique de la Bauge, et Babuso décrivit celle de l'Adobe et de la terre compactée.

Les meilleurs maçons de Goa sont connus comme provenant de la région de Pernem. Souvent, chaque famille compte la présence d'un maçon en son sein.

C. MURS ET TYPOLOGIES

Les constructions en pisé étudiées à Goa présentent des murs avec des finitions douces et uniformes. Les couches ne sont pas visibles. Les murs font entre 32 et 40cm.

Les marques de trous laissées par les banches de pisé étaient rebouchés, et les murs étaient bâtis avec des bêtes en bois durant la construction. Ceci afin d'atteindre un meilleur niveau de compaction, et une surface plus nette. A Salgini, il est dit que les roches latérites étaient utilisées dans la construction. Elle ne sont cependant pas visibles sur la surface des murs.

**Le fait de battre le pisé à l'aide de bêtes en bois est peut-être inspiré de la technique de la Bauge, présente sur le territoire.*

Les maçons expliquent que les murs en pisé présente une surface plus nette, mais une résistance inférieure aux murs en Bauge, en raison du climat de Goa. Lors de fortes pluies, la terre se désagrège plus rapidement dans les murs en pisé.

A Goa, les briques d'adobe sont utilisées pour monter des murs pleins, des gâbles, mais aussi pour les fondations. La taille des briques varie d'un bâtiment à l'autre. Plusieurs dimensions ont été rencontrées, parfois à l'intérieur d'un même mur : 24x14cm, 30x14cm, 34x14cm (Etudes n° 4). Dans un autre bâtiment : 43x19cm (Etudes n° 10).

Dans le pisé étudiée en Alentejo, la taille des banches varie de 1,50 à 2,50m, et leur hauteur de 45 à 55cm. Les murs extérieurs mesurent entre 40 et 57cm.

L'Alentejo présente une grande variété de typologies de terre compactée. Les blocs de pisé sont fait d'une ou de deux couches. Certaines constructions sont de typologies plutôt simples, i.e. sans matériel de renforcement entre chaque couche. D'autres présentent des mortiers, des mortiers + briques de terre cuite, des mortiers + schist, des adobes, etc.

Dans certaines parties de l'Alentejo, les briques d'adobe étaient utilisées principalement pour bâtir les murs internes, gâbles, etc. On trouve aussi des murs externes bâtis en adobe. La dimension des briques varie : 30x20x10cm (Etudes n° 1[1]), 30x17x8cm (Etudes n° 7[39]), and 33x16x10cm (Etudes n° 8[40]).

D. DETAILS CONSTRUCTIFS

A Goa comme dans l'Alentejo, on avait recours aux matériaux locaux pour bâtir. Les détails constructifs témoignent de l'adaptation de l'architecture à ces ressources locales, voici quelques exemples :

Les bases de murs et les angles étaient bâtis en terre avec ou sans roche latérite.

Souvent, lorsque la base était faite de terre, les angles aussi, et si elle était faite de latérite, alors les angles aussi.

Les bases de murs étaient bâties en roches et en briques de terre cuite. Les angles étaient bâtis en terre avec ou sans roche latérite.

- Aucun renfort ou tirant n'a été référencé dans les bâtis étudiés à Goa. Les renfort sont plus généralement présent dans les bâtiment plus grands, comme les églises.

- Trous laissés par le coffrage (pisé) et remplis par la terre.



Trous laissés par le coffrage (pisé) et remplis par la terre.

- Toutes les toitures de Goa possèdent de grand débordements de toiture. De plus, des toitures provisoires de protection étaient ajoutées contre les murs ou au dessus des fenêtres peu avant la saison des moisson chaque année. Les toitures permanentes sont généralement fait de tuiles, tandis que les toitures provisoires, étaient elle faite de palmes de cocotiers, couvertes de bâches ou de tôle de métal.



Débordements, les maisons à Goa.

- On rencontre des renforts ou tirants dans certaines constructions d'Alentejo. Plus particulièrement dans les constructions ne présentant pas de renforts horizontaux entre chaque couche, et dans les régions sismiques.

- Dans les murs construits en terre fine, trous laissés par le coffrage et remplis de mortiers.



Trous laissés par le coffrage et remplis de mortiers.

[Source: Correia, *Le pise d'Alentejo, Portugal*, 2000]

- Certaines constructions présentent de légers débordements de toiture, faits de briques de terre cuite ou de schist, et souvent bien suffisant pour protéger les murs des pluies, relativement modérées dans la région.



Débordements, les maisons au Portugal.

[Source: Correia, *Le pise d'Alentejo, Portugal*, 2000]

E. MORTIERS

Les mortiers sont présents dans les constructions de bases et d'angles construits en roches latérites, et celles faites d'adobe. On ne trouve pas de mortier dans les structure en pisé ('Région B', Salgini).

Les mortiers sont présents autant dans les constructions en pisé que celles d'adobe :

- Joints horizontaux et verticaux entre les couches de pisé.
- Entre les murs en pisé et la charpente.
- En remplissage des trous de banche.
- Dans la maçonnerie d'adobe.

F. ENDUITS, RENDUS, PIGMENTS ET/OU PEINTURES

- Traditionnellement, les murs externes des constructions de Goa étaient enduits et/ou peints. On observait une tendance à laisser le mur arrière exposé (aujourd'hui, l'intégralité des murs sont enduits). **Dans tous les cas, la façade principale était enduite, et/ou peinte.**

- **Les façades principales étaient généralement enduites et/ou peintes.**

<ul style="list-style-type: none"> ◦ A l'intérieur, les pièces de service, comme la cuisine, ou les espaces de stockage, recevaient des traitements de surface de moins bonne qualité : une simple couche de chaux, en peinture plus qu'en enduit, ou parfois même aucun traitement de surface. <p>Les murs externes comme internes de bâtiment secondaire (étable, distillerie, etc.) ne recevaient généralement aucun traitement de surface.</p> <ul style="list-style-type: none"> ◦ Certaines maisons possédaient des pigments ou des peintures sombres, le long des colonnes, des motifs, des bases de murs, particulièrement les façades avant. (parfois aussi sur les murs internes) ◦ Les ocres blanches, rouges, bleues étaient communes d'usage. 	<ul style="list-style-type: none"> ◦ Les murs externes comme internes de bâtiment secondaire (annexe agricole, étable, etc.) recevaient des traitements de surface de moins bonne qualité : une simple couche de chaux ou terre, en peinture plus qu'en enduit, ou parfois même aucun traitement de surface. <p>Les murs étaient généralement peints de blanc. Les bases de murs et les encadrements de portes et de fenêtre étaient souvent peints de couleurs.</p> <ul style="list-style-type: none"> ◦ Les ocres blanches, rouges, grises, bleues étaient communes d'usage.
---	--

G. MATIERES UTILISEES ENDUITS, RENDUS, PIGMENTS ET/OU PEINTURES

<ul style="list-style-type: none"> ◦ La terre et/ou la chaux étaient utilisées pour les mortiers. Parfois des mélanges terre/chaux étaient utilisés. ◦ Les <u>enduits</u> étaient principalement réalisés à la chaux. ◦ La chaux provenait traditionnellement du traitement de coquillages (appelés 'chuno' en Konkani). ◦ Pour les <u>pigments</u>, l'ocre et le rouge étaient disponibles naturellement, comme dérivés de latérites. Le pigment bleu provenait de l'indigo, importé de l'Inde au Portugal via le port de Goa.^[18] ◦ On trouvait du ciment dans quelques mortiers et enduits. Mais c'est dû à une intervention plus récente. 	<ul style="list-style-type: none"> ◦ La terre et/ou la chaux étaient utilisées pour les mortiers. ◦ Les <u>enduits</u> étaient principalement réalisés à la chaux ou en terre. ◦ La chaux provenait de la combustion de roche calcaire. On trouve deux variétés de chaux : la chaux blanche ('cal branca' en Portugais), et la chaux noire ('cal preta', 'cal parda', 'cal de obra' ou 'cal morena'). ◦ Pour les <u>pigments</u>, l'ocre et le rouge étaient disponibles naturellement dans le sols. Le gris provenait des cendres de cheminées. Le pigment bleu était disponible sous forme de poudre. ◦ On trouvait du ciment dans quelques mortiers et enduits. Mais c'est dû à une intervention plus récente.
---	--

H. TERMINOLOGIE

Certain mots présents dans la langue Konkani (particulièrement les dialectes utilisés dans la 'Nouvelles Conquêtes') semblent dériver de la langue Portugaise.

<ul style="list-style-type: none"> ◦ Une construction en pisé est référencée comme 'taip' en Konkani. ◦ Une brique d'adobe est appelée 'box', qui provient de l'Anglais. Le maçon Bernado utilisé lui le mot 'caix' ('caixa' signifiant 'box' en Portugais). <p><i>*Les maison en Bauge sont appelées 'mathe ghor' en Konkani. Ce qui signifie littéralement 'maison construites en terre'.</i></p>	<ul style="list-style-type: none"> ◦ Une construction en pisé est référencée comme 'taipa' en Portugais. ◦ Une brique d'adobe est appelée 'tijolo cru' en Portugais.
---	--

¹⁸ Nadri, *The Political Economy of Indigo in India, 1580-1930: A Global Perspective*. p.86,97

D'autres vocabulaires liés à la construction en pisé ont différentes appellations en Konkani et en Portugais.

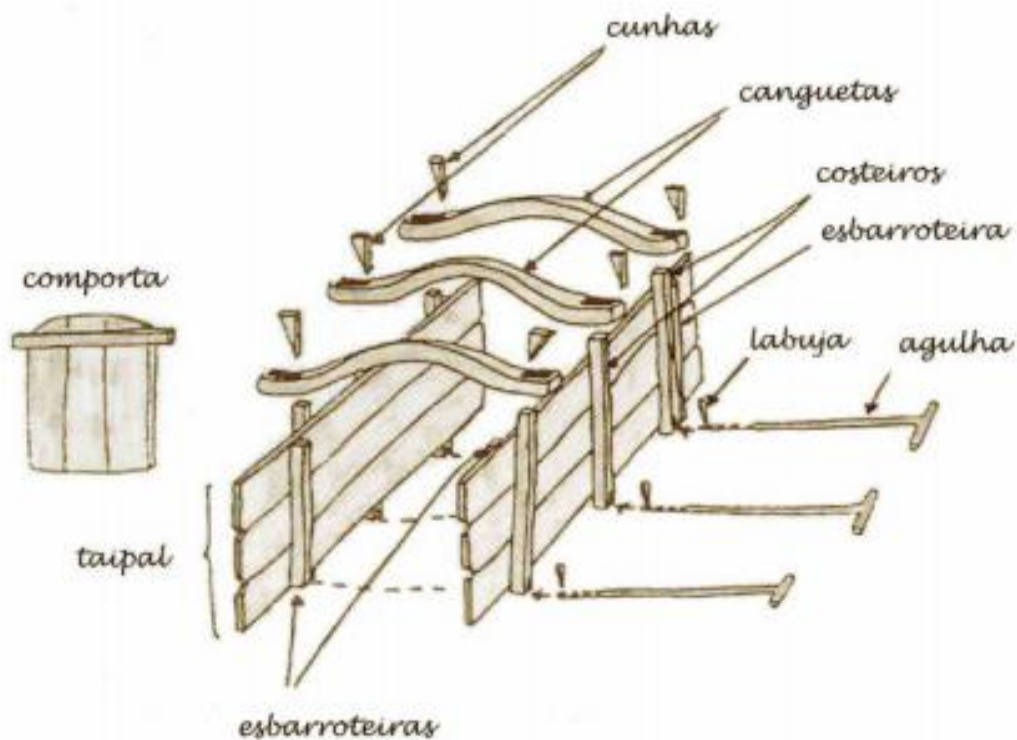

Parts of the rammed-earth frame-work. [Source: Parreira, *Análise Sísmica de uma Construção em Taipas*, p.7]

Anglais	Konkani	Portugais
Pisé	Taipp ^[19]	Taipas, taipal
Stop-fin	Phodé, holé	Comportas
Cale	Vanyo (?), kovyo (?), kutti ^[20]	Cunhas
Boulon		Cadeias / Canguetas
Nervure	Vanshe ^[21]	Costeiros
Pince		Labuja
Clou	Arão, kiddi, ^[22] chavi ^[23]	Agulhas
Entretoise	Kani	Côvados
Pisoir	Musal	Maços
Tasseau	Patnem ^[24]	
Banche verticale		Esbarroteira
Banche horizontale	Fadim ^[25]	
Bâte en bois	Pattnem ^[26] (seulement à Goa)	
Autre vocabulaire relié à la construction :		
<ul style="list-style-type: none"> ◦ Couche ◦ Couche entre les couches (constructions en Pisé) ◦ La première couche, la plus basse (constructions en Bauge) 	<ul style="list-style-type: none"> ◦ Parro (singular), paré (plural)^[27] ◦ Teno, tor, intuj 	<ul style="list-style-type: none"> ◦ Fio de taipas ◦ Camada
Chaux	Chuno	Cal

¹⁹ Lobo, *Earth in Architecture*, p.44

²⁰ Ibid.

²¹ Ibid., p.45

²² Ibid., p.44

²³ Ibid.

²⁴ Ibid., p.50

²⁵ Ibid., p.45

²⁶ Ibid., p.44

²⁷ Ibid.

Autres mots Konkani relié à la construction, influencés du Portugais :		
Balcon / veranda	Sopo (singulier), sope (pluriel), balkâmv , ^[28]	Balcão , ^[29] varanda
Chapelle	Copel	Capela
Eglise	Igoj, firgoz	Igreja (église), freguesia ^[30] (paroie)
Béton	Beto	Betão
Fondation	Gharachi bunyad, beto ('betão' signifie 'ciment' en Portugais)	Fundação
Halle	Chowk, sal, saletas ^[31]	Sala de entrada, saletas
Marteau	Hatodi, mortel	Martelo
Trou	Burak	Buraco
Echelle	Nosan, escade	Escada
Maçons	Govno, pedrel, pedreiro ^[32]	Pedreira (singulier), alvanéus (utilisé avant 19th siècle)
Maître artisan (maçons ou Charpentiers) ^[33]	Karagir, mestre , ^[34] fishaal, ^[35] meste , ^[36] maestre , ^[37] mistri , ^[38] gavandi ^[39]	Mestre
Charpentiers	Mest , sutars, ^[40] thovoi (Sud Goa), ^[41] chari (North Goa) ^[42]	Carpinteiros
Four	Forn	Forno
Particules	Kuskut, particule	Partículas
Pickaxe	Pikander , ^[43] pikandar, pikao , ^[44] pikas	Picareta
Truelle	Thapi, ^[45] culher	Colher
Bois	Lakud, moder	Madeira
Porte en bois	Lakdache dar, casil	Caixilho
	Monte (chapelle au sommet d'un colline)	Monte (maison au sommet d'une colline) ^[46]
	Tizule (carrelage)	Tijolo cru (adobe), tijolo cozido (terre-cuite)

I. DATE DE CONSTRUCTION

Il serait intéressant de comparer les dates de réalisations des constructions en terre de Goa avec celle du Portugal et d'observer lesquelles précèdent les autres selon la région. L'hypothèse étant que l'une des régions ait influencé l'autre.

◦ Six (sur 13 constructions en Bauge) étudiées à Goa dataient de plus de 100 ans ('Région A' — Etude n° 2, 4, 5, 7, 8; 'Région B', Neturlim — Etude n° 15). Les autres furent construites il y a entre 50 et 80 ans ('Région A' Etude n° 3 (en 1940s), 6 (1965), 9 (1949-50), 10 (1970, incluant des gâbles d'adobe), 11 (1967); 'Région C' — Etude n°14 (1952)).

◦ Six (sur 12 constructions en pisé) étudiées en Aletenjo dataient de plus de 100 ans ('Région B' — 3[9], 4[10], 5[11]; 'Région C' — Etude n° 6[14], 7[39], 'Région E' — Etude n° 11[25]). Trois dataient d'environ 70/100 ans ('Région A' — Etude n° 1[1] (en 1920, incluant des murs internes en adobe), 2[38] (1927); 'Région C' — Etude n° 8[40] (+/- 1950), incluant des gâbles d'adobe). Une construction en

²⁸ Silveira, *Lived Heritage, Shared Space: The Courtyard House of Goa*, p.104

²⁹ Ibid., p.104

³⁰ Correia, *Rammed Earth in Alentejo*, p.21

³¹ Pandit, *Hidden Hands: Master Builders of Goa*, p.97

³² Ibid., p.89

³³ Ibid., p.88

³⁴ Ibid., p.88, 94

³⁵ Ibid., p.88

³⁶ Ibid., p.111

³⁷ Ibid., p.89

³⁸ Ibid., p.94

³⁹ Ibid., p.105

⁴⁰ Ibid., p.87

⁴¹ Ibid., p.88

⁴² Ibid.

⁴³ Ibid., p.93

⁴⁴ Ibid., p.106

⁴⁵ Ibid.

⁴⁶ Correia, *Rammed Earth in Alentejo*, p.22

- Les gâbles de briques d'adobe ('Région A' — Etude n° 4), et les constructions en pisé ont été construites plus récemment et datent de moins de 30 ans ('Région B', Salgini — Etude n° 12 (environ 1988), 13 (terminée en 2014)).
- Selon une autre étude (Lobo, *Earth in Architecture*, 2006, p.41) : « In Goa, the rammed-earth technique is much more recent as compared to the other wall construction techniques. As surveyed, most houses built in rammed-earth were about 75-85 years old, while very few were about 100 years of age. »

*« Cob construction is a wall construction technique which is the most popular and has been in almost all parts of Goa. » (Lobo, *Earth in Architecture*, 2006, p.47).

pisé date de moins de 25 ans ('Région E' — Etude n° 12[27]).

J. OUTILS ET BANCHES A PISE

Des photos d'outils, banches traditionnelles et banches modernes ont été collectées à travers de cette étude. Les banches, que ce soit à Goa comme en Alentejo, continuent d'évoluer avec le temps.



[Source: Soeiro de Brito, *Goa e as Praças do Norte*, 1966, p.50]

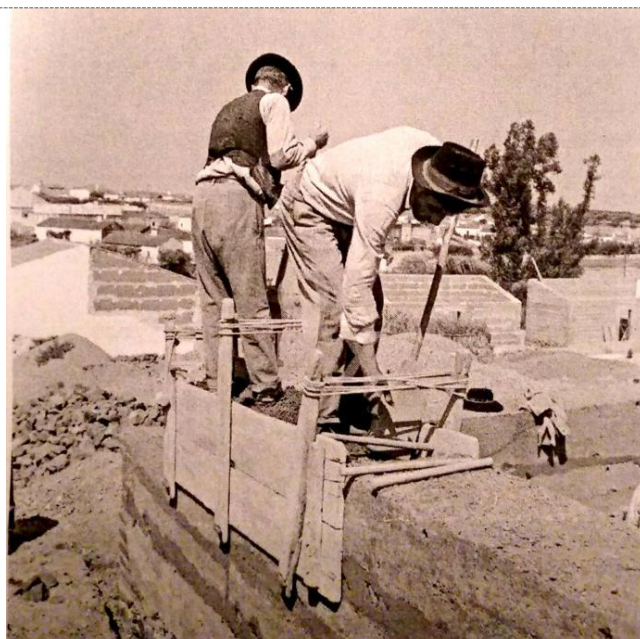

[Source: Partager par Maçon-Cruiser, Joaquim Antonio Baptista]



Banche traditionnelle de l'Alentejo

[Source: Associação Centro da Terra. *Arquitetura de Terra em Portugal. Earth Architecture in Portugal*, 2005, p.23]



Banche traditionnelle et entretoise ('kani' in Konkani)
 [Source: Lobo, *Earth in Architecture*, 2006, p.42]



Banche traditionnelle utilisée par Aldeia da Luz à avant 1950.
 [Source: Museu da Luz, Luz, Évora, 2018]

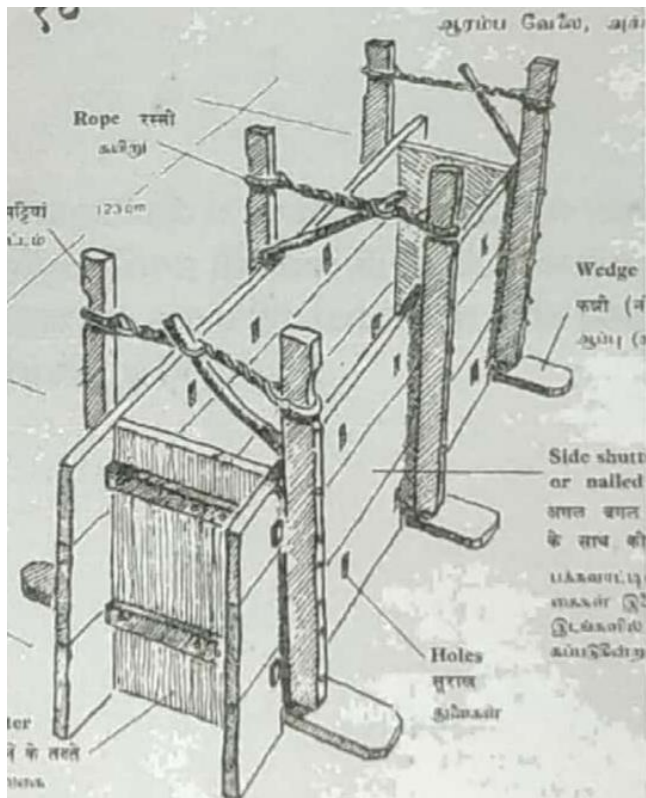

[Source: Lobo, *Earth in Architecture*, 2006, p.42]



[Source: Parreira, *Análise Sísmica de uma Construção em Taipa*, 2007]

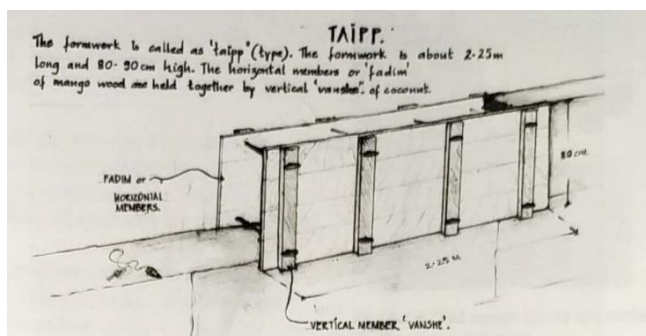

Banche traditionnelle avec boulons ('arão', 'kitti', or 'chavi' in Konkani) et entretoise [Source: Lobo, *Earth in Architecture*, p.45]



Maquette réalisée par un maçon
 [Source: Catarina Pereira (Architect, Portugal), 2018]



Banche traditionnelle, boulon, entretoise, et outils
 [Source: Lobo, *Earth in Architecture*, p.44]



[Localisation: Museu da Luz, 2018]

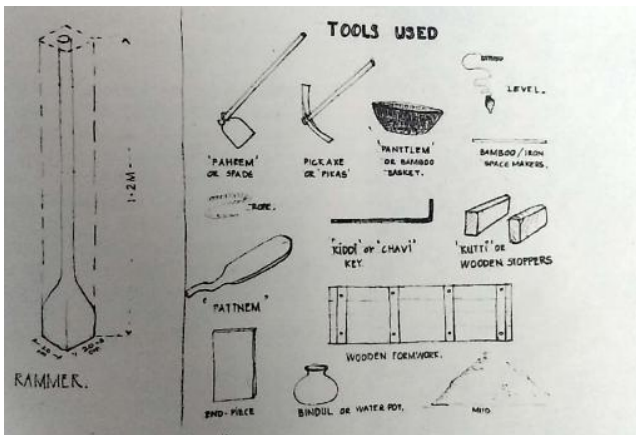

Banche traditionnelle, boulon, entretoise, et outils
 [Source: Lobo, *Earth in Architecture*, p.44]

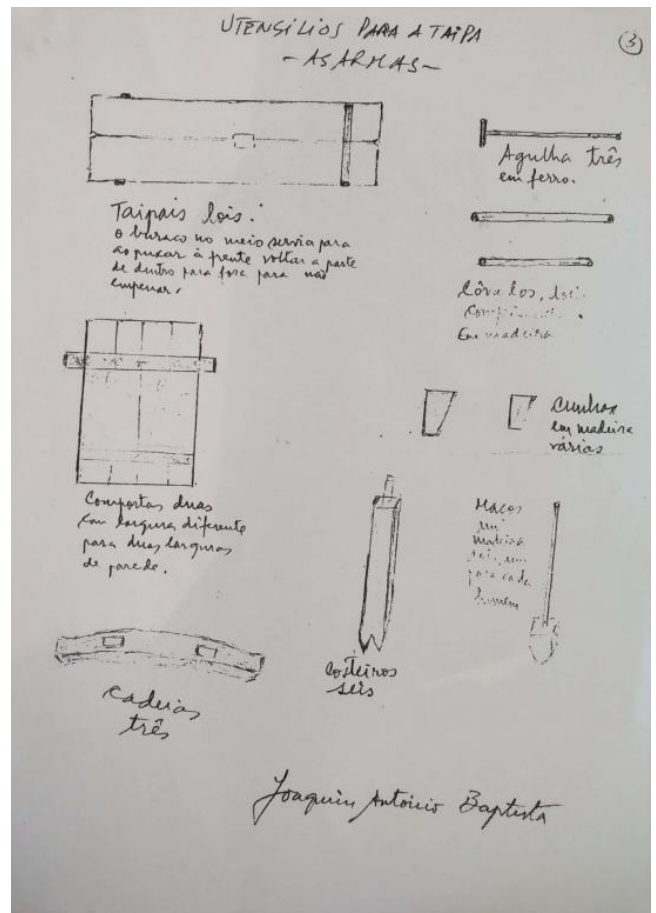

[Dessin du Maçon-Cruiser, Joaquim]



Truelle et 'pattnem' du Maçon Bernardo Sequeira.



'Pattnem' utilisé par les constructeur-propriétaires dans le village Salgini pour construire leurs propres maisons en pisé.



Les outils du Maçon-Cruiser, Joaquim.



Vérification du niveau par fils à plombs.
 [Source: Lobo, *Earth in Architecture*, p.43]



Maçon-Cruiser Joaquim montrant ses fils à plombs des constructions en pisé, datant de 100 ans.

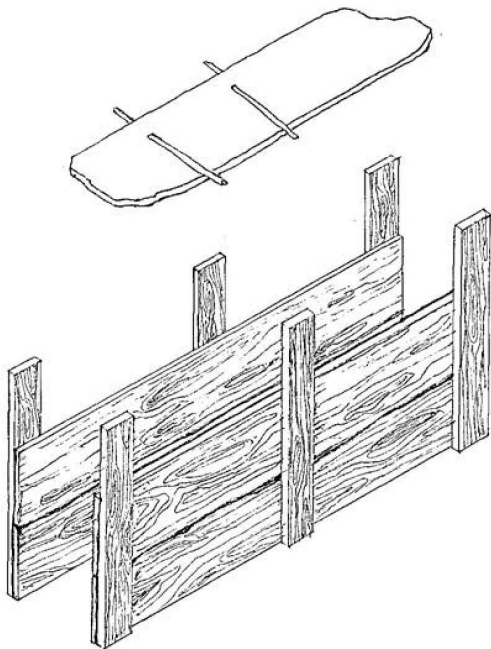

Exemple de banche moderne, Portugal (2 images).
 [Source: BION. Building Impact Zero Network.
 Location: Galeria Municipal, Montemor-o-Novo, Évora, 2018]



Les parties des banche utilisés récemment à Goa (4 images).
 [Dessins par Lionel Afonso]



Exemple de banche moderne, Goa.



Exemple de banche moderne, Goa.



Exemple de banche moderne, Portugal.

[Source: Facebook, João Bernardino, Lda. Construções Ecológicas, June 8, 2018]

Détails de la banche à pisé utilisée à Goa:

- Banche traditionnellement faite de manguier.^[47]
- **Dans les anciennes banches, se trouve des cordes pour sécuriser les cales.**
- Plusieurs planches en bois ('*fadim*' en Konkani), pour former la banche ('*taipp*' en Konkani).
- Une bête en bois ('*pattnem*' en Konkani) pour compacter le pisé durant la construction.

Détails de la banche à pisé utilisée au Portugal:

- Banche faite de pin.^[48]
- **Dans les anciennes banches, se trouve des cordes pour sécuriser les cales ('*costeiros*' in Portuguese).**
- Planches en bois ('*taipas*' ou '*taipal*' en Portugais).

⁴⁷ Lobo, *Earth in Architecture*, p.42

⁴⁸ Pereira, *Savoir-faire, Enseignement et Construction en Pisé Dans Le Bas Alentejo*, p.38

9.2. APPROCHES DE CONSERVATION

A. DÉGÂTS, PROBLÈMES ET DÉFIS RELEVÉS

- | | |
|--|---|
| <ul style="list-style-type: none">◦ Bâtiment en ruine.◦ Toit : Fissures des tuiles (en particulier pendant les moussons lorsque les animaux marchent sur les tuiles humides) entraînant des fuites d'eau, dégâts aux chevrons et décomposition de la charpente de toit due aux attaques de termites.◦ Murs : Renflement dans les murs, fissures, humidité dans les murs, désintégration de certaines parties des murs (en particulier les coins), trous dans les murs (parfois faits par des oiseaux, des rats, etc.), trous d'abeilles, érosions des bases des murs, érosion des murs par les ruissellements d'eau, nids de terre sur les murs intérieurs par les insectes, assombrissement des murs de la cuisine à cause des poêles à bois, écaillage et chutes de plâtre.◦ Sols : sols ébréchés, trous, humidité pendant les moussons | <ul style="list-style-type: none">◦ Bâtiment en ruine.◦ Toit perdu dans des incendies, déstabilisation et dislocation des tuiles provoquées par les vents, fissuration des tuiles même si les animaux marchent dessus pendant les moussons, décomposition de la charpente.◦ Murs : effondrement de certaines parties des murs, fissures, trous, trous d'abeilles, mortiers dégradés, enduits gondolé et tombants, graffiti.◦ Sols: dalles ebrechées |
|--|---|

B. ENTRETIEN ET RÉPARATIONS

- | | |
|--|---|
| <ul style="list-style-type: none">◦ Toit : entretien régulier du toit nécessaire◦ Murs : barrières à l'eau de pluie installées temporairement avant les moissons, réparation des fissures, remplissage des parties des murs désintégrées, peinture annuelle des murs avant les festivals.◦ Sols : remettre les couches régulièrement des sols avec du fumier et de l'oxyde rouge. | <ul style="list-style-type: none">◦ Toit : entretien régulier du toit nécessaire◦ Murs : réparation des fissures, contreforts et/ou tirants ajoutés pour stabiliser les murs, blanchiment annuel des murs avant les fêtes du village. |
|--|---|

C. PLANS FUTUR

La plupart, sinon tous les propriétaires, ont l'intention de démolir leurs maisons en terre et de reconstruire la maçonnerie en latérite et en ciment. Il est communément admis que ce dernier matériaux est meilleur et plus résistante.

Certains propriétaires ont bloqué les réparations et la reconstruction de leur maison soit par ce que la répartition des biens entre les héritiers est toujours en suspens, soit par ce qu'ils attendent les conditions de propriété. (Conformément à la loi «Goa Mundkar Protection from Eviction Act 1975», les locataires ont le droit à leur parcelle de terrain s'ils y vivent depuis des générations et remplissent certains critères.)^[49]

Certains propriétaires ont indiqué qu'ils continueraient à utiliser leurs bâtiments tel qu'ils sont. Un seul a dit qu'il souhaitait reconstruire sa maison en briques cuites car il ne fait pas confiance aux constructions en pisé.

⁴⁹ Merchant, "Tenant cannot become mundkar: HC," *The Times of India*, November 27, 2012

10. CONCLUSION

Deux techniques de construction en terre se sont révélées communes à Goa et au Portugal : le Pisé et les briques d'Adobe.

Deux bâtiments étudiés (sur 16) étaient en terre battue et deux avaient des briques d'Adobe. Les autres étaient en Bauge. Dans un cas, la **technique de construction** n'a pas pu être identifiée. Les 12 structures étudiées à Alentejo étaient en Pisé. Trois d'entre elles comprenaient également des briques d'Adobe.

Curieusement, la **terminologie** utilisée pour désigner les bâtiments en pisé était similaire à Goa et au Portugal. La terre battue est appelée « taip » à Goa et « taipa » au Portugal. A Goa, les briques d'Adobe sont appelées « Box » (dérivé de l'anglais), bien qu'un des maçon interrogé ait qualifié la brique d'adobe ou le moule en brique d'Adobe de « caix » (« caixa » signifie « boîte » en portugais). Au Portugal les briques d'adobe sont appelées « tijolo cru ».

Les **dates de construction** des structures dans les deux régions ont été analysées. Les constructions en terre battue étudiées à Goa pour cette étude avaient moins de 30 ans. Cependant, une autre étude mentionne que la terre battue est une technique récente à Goa, la plupart des maisons étant âgées de 75 à 85 ans; seules quelques-unes ont environ 100 ans (Lobo, *Earth in Architecture*, 2006). Les constructions en brique d'adobe étudiées à Goa étaient également relativement récentes – par rapport aux constructions en Bauge, qui étaient plus anciennes, avec de nombreux bâtiments datant de plus de 100 ans.

Les photos montrent que les coffrages en terre battue à Goa et au Portugal ont évolué avec le temps. Une similitude frappante observée dans les anciens coffrages utilisée dans les deux régions était l'utilisation de cordes pour fixer les « nervures » (c'est à dire les éléments verticaux des volets).

Le manque de clarté de la terminologie utilisée pour désigner les briques d'adobe et l'ambiguïté de la datation de la période où les constructions en briques d'adobe ont commencé à Goa ne permettent pas de déduire avec précision si cette technique a une influence portugaise. Cependant, **les bâtiments en pisé à Goa et au Portugal ont des appellations similaires (« taip » à Goa et « taipa » au Portugal). En outre, les bâtiments en terre battue à Goa sont relativement nouveaux (en comparaison à la technique du Bauge). Ils ont commencé à être construits au début du XXe siècle, c'est à dire quelques décennies avant que les portugais ne quittent Goa en 1961 (Lobo, *Earth Architecture*, 2006). Cela pourrait indiquer que la terre battue a été introduite à Goa par les portugais.** L'étude pourrait aller plus loin encore, afin d'éclairer davantage ces résultats.

Le fait que les ouvriers traditionnels de Goa exprime que les sols des murs en terre battue ont tendance à se détacher et se morceler en raison de fortes précipitations suggère que les bâtiments en terre battue ne résistent pas aux conditions climatiques de Goa. Les propriétaires-construteurs de la communauté forestière du village de Salgini ont également mentionné qu'auparavant les maisons étaient « moulées à la main » (indiquant des constructions en Bauge) mais qu'aujourd'hui la technique de la terre battue est utilisée. Cela pourrait encore suggérer que la technique du pisé n'est pas indigène à Goa.

D'un autre côté, il a été observé que les constructions indigènes en torchis et leur appellation Konkani « mathe ghor » (qui se traduit simplement par « maison construite en terre ») étaient couramment utilisées dans les « Vieilles Conquêtes » (régions de Goa saisies par les portugais de 1510 à 1543). Cependant, des constructions en pisé et l'utilisation du terme « Taip » ont été observés dans les « Nouvelles conquêtes » (régions capturées de 1763 à 1788). Dans les « Nouvelles conquêtes » le terme « taip » était parfois utilisé pour désigner une maison en terre, et pas précisément une maison en pisé. Il est intéressant de voir comment les « Vieilles Conquêtes », qui ont une influence culturelle et architecturale portugaise forte, ^{[50][51][52][53]} conservent toujours la technique et le vocabulaire de la construction indigènes, et comment les « Nouvelles conquêtes » ont adoptés ces techniques qui ont probablement été influencées par les portugais.

Outre les terminologies, les dates de construction et les coffrages en terre battue utilisés, des similitudes ont également été observées dans divers « détails de construction », « plâtres, enduits, pigments et/ou peintures » et « approches de conservation ». Cependant, il s'agit probablement de similitudes standards observées dans les constructions en terre en général, ou d'une réponse aux matériaux locaux et aux micro-environnements auxquels Goa et Alentejo sont respectivement soumis – et pas nécessairement une influence d'une région sur l'autre. **Cependant, l'utilisation de la couleur bleue sur les murs des maisons de Goa et du Portugal pourrait être une caractéristique commune car l'indigo,**

⁵⁰ Borges and Feldmann, eds., *Goa and Portugal: Their Cultural Links*, p.41-47

⁵¹ Rangel-Ribeiro, ed., *Goa Aparanta – Land Beyond the End*, p.200-201

⁵² Pandit, *Hidden Hands: Master Builders of Goa*, p.100

⁵³ Silveira, *Lived Heritage, Shared Space: The Courtyard House of Goa*, p.72

d'où provient le pigment bleu, a été transporté de l'Inde au Portugal via le port de Goa, et est donc disponible dans les deux régions.

Aujourd'hui il y a un renouveau des constructions en terre à Goa et au Portugal. Le pisé est actuellement populaire à Goa et au Portugal, la terre battue, les briques d'adobe et les blocs de terre compressés sont connus.

.....

(En anglais / in English)

**Comparison of the vernacular earthen architecture in
Goa (past Portuguese colony in India) and Alentejo (Portugal):
Local building cultures and conservation approaches**

I. INTRODUCTION

Comparison of the vernacular earthen architecture in Goa (past Portuguese colony in India) and Alentejo (Portugal): Local building cultures and conservation approaches

1. CONTEXT

1.1. GOA AND PORTUGAL: A SHARED HISTORY

Portugal was the first nation-state in Europe to establish an overseas colonial empire, and (along with Spain) holds the record for being the first modern global empire.^{[54][55]} The Portuguese Empire (1415-1999) constituted lands that spread across America, Africa and Asia.^[56] One of the longest occupied Portuguese territories (after those in Africa) was Goa (India).

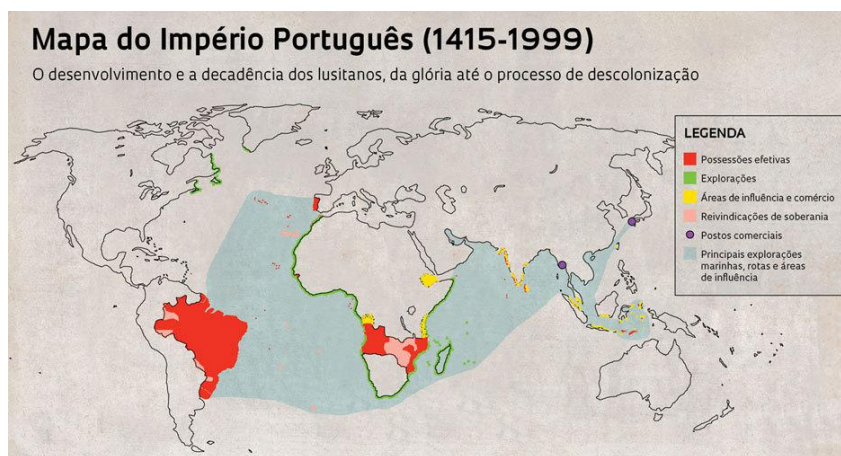

Image 9: Map of Portuguese colonies.
[Source: www.mapsontheweb.zoom-maps.com]

The Portuguese reigned over Goa for 451 years (1510-1961). In various Portuguese records Goa is referred to as 'Estado da Índia'^[57] (State of India), 'Estado Português da Índia' (Portuguese State of India), or 'Índia Portuguesa' (Portuguese India).

After the Portuguese left, Goa was a part of Union Territory of Goa, Daman and Diu. A referendum popularly known as the Opinion Poll was held in 1967, which voted for Goa to become a independent entity.^{[58][59]} On 30th May 1987, Goa attained the status of a separate state.^[60] In spite, till today, some cite discord in connection to Portugal's surrender and Goa's annexation to India,^[61] and what is referred to as 'Liberation of Goa' by some is referred to as 'Invasion of Goa' by others.

Goa is currently divided into 12 'talukas' in the Indian political system. Four of these form the Old Conquests or 'Velhas Conquistas' referring to the regions that were taken over by the Portuguese in the 15th Century. The rest were captured later and form the New Conquests or 'Novas Conquistas'. The Old Conquests include Tiswadi (taken over in 1510), Bardez, Mormugao and Salcete (1543). The New Conquests include Ponda, Dharbandora, Sanguem, Quepem and Canacona (1763), Pernem, Bicholim, Satari, (1788).^{[62][63]} Naturally, the old conquests display a stronger Portuguese influence than the new conquests.

⁵⁴ Page, *Colonialism: An International Social, Cultural and Political Encyclopedia Volume 1*, p.481

⁵⁵ Phillips, *A Concise History of Spain*, p.134

⁵⁶ Brockey, *Portuguese Colonial Cities in the Early Modern World*, p.xv

⁵⁷ Issar, *Goa Dourada*, p.169

⁵⁸ Rangel-Ribeiro, ed., *Goa Aparanta – Land Beyond the End*, p.56

⁵⁹ Gomes, *A Concise History of Goa*, p.329-331

⁶⁰ www.goa.gov.in

⁶¹ Lobo, *FREE GOA from INDIAN Invasion & it's Continued Illegal Occupation against UN Resolution,*

https://www.change.org/p/prevent-genocide-of-goan-christians-by-communal-corrupt-illegal-indian-administration-in-go-a-former-portuguese-colony-where-goans-are-forced-to-immigrate-from-their-own-motherland-to-other-countries?use_react=false (accessed September 11, 2019)

⁶² Pereira, *Ethnography of Goa, Daman and Diu*, p.11

⁶³ Khedekar, *Goa: Land, Life and Legacy*, p.4



Image 10: Old and New Conquests, Goa.

[Source: Hall, 1992, p.14]

Portugal — and its colonies — have influenced the cuisine, art, architecture, music, religion, education, policies and administration of the state of Goa. This is witnessed in both, the old and new conquests. However, while imbibing the Portuguese culture, Goa has also retained its indigenous culture too. Even today, the culture of Goa continues to exhibit a unique blend of Indian and Portuguese elements, more appropriately described as 'Indo-Portuguese' culture.^{[64][65]}

Portugal and Goa, including the whole of India continue to share a good relationship. Various organisations such Fundação Oriente, Camões Instituto da Cooperação e da Língua, and Lusophone Society of are based in Goa and promote Portuguese language and culture. Similarly in Portugal, organisations such as Casa de Goa; Comunidade Hindu de Portugal; Associação Cultural De Amigos De Goa, Damão E Diu; and Associação Recreativa e Cultural Indo-Portuguesa propagate the Goan and Indian culture in Portugal.

1.2. (EARTHEN) ARCHITECTURE OF GOA AND PORTUGAL: A SHARED HERITAGE...

Various studies and theories exist on the extent of Portuguese influence on the Goan culture. An area that has been extensively researched is the architecture, especially that of the churches and houses often referred to as 'Portuguese houses', 'Indo-Portuguese houses', 'Indo-European houses', 'Heritage houses of Goa' or simply 'Houses of Goa'. While these are often in reference to big manorial houses, what remains less researched are the smaller dwellings that belonged to the middle and lower class. Another very important aspect that is less researched is that of the materials and technologies used to build the various structures.

A striking resemblances in domestic architecture can be spotted in the earthen houses built in layers of earth, seen in both, Goa and particularly in the Alentejo region of Portugal. In Goa, most houses are plastered and hence it is hard to read the materials and techniques in which these houses were built. In order to bridge the link and find measures that would safeguard this shared heritage in both Goa and Portugal, this study mainly aims to:

- 1) Understand whether Portugal's vernacular earthen architecture influenced that of Goa, and vice-versa during the 451 years Portuguese reign in Goa i.e. 1510-1961.
- 2) Gathering an understanding of local building cultures and conservation approaches in both regions, with an intention that this information would facilitate the upkeep of these earthen buildings today.

⁶⁴ Borges and Feldmann, eds., *Goa and Portugal: Their Cultural Links*, p.41-47

⁶⁵ Rangel-Ribeiro, ed., *Goa Aparanta – Land Beyond the End*, p.201

2. METHODOLOGY

2.2. SINCE THE PRELIMINARY PLAN...

During my initial research, I unearthed a previous DPEA-Terre dissertation: 'Le Pise d'Alentejo' by Architect Mariana Correia (2000), which was later translated into Portuguese and English, and published into a book: 'Taipa no Alentejo. Rammed Earth in Alentejo' (Lisbon, 2007). As the study was directly related to my topic, 'Comparison of the Vernacular Earthen Architecture of Goa (past Portuguese colony in India) and Alentejo (Portugal): Local Building Cultures and Conservation Approaches', on consulting my professors and Mariana, I decided to purpose the book as a base for my research.

While Mariana's dissertation concentrated on 'local building cultures', mine included 'conservation approaches' as well.

The content format and case-study format for my research was borrowed from Mariana's. The same methodology was followed in both, Alentejo and Goa, in order to maintain uniformity in the type of data collected, and thus make comparisons between both regions achievable.

In addition, for the part on Alentejo, some content, including the case-studies were derived from Mariana's study and revised by me. A new category, 'Conservation approaches', and the part on Goa were my contributions.

Text edited, rewritten and/or revised by me based on the work of Architect Mariana Correia is indicated in brown color, and/or with the mention, 'Rewritten / revised by Chenelle Rodrigues based on the work of Mariana Correia ('Pise d'Alentejo', 2000; 'Taipa no Alentejo. Rammed Earth in Alentejo', 2007).'

The methodology adopted for my study, 'Comparison of the Vernacular Earthen Architecture of Goa (past Portuguese colony in India) and Alentejo (Portugal): Local Building Cultures and Conservation Approaches' is detailed in the following sections:

- Visit to Goa and Portugal
- Selection of structures
- Other challenges
- Survey methodology and analyses
- Case-study format
- Analyses and conclusion

2.2.1. VISIT TO GOA AND PORTUGAL

During the duration of this research i.e. January 2018 – January 2020, I spent about one year in Goa, and two months in Portugal. For the rest of the time, I was in France doing internships and other projects related to earth building, and writing my dissertation.

I was born and raised in Goa, and while conducting this research, I stayed in my native village, Colva in South Goa. I am obviously well-connected with Goa's culture, and over the years, I have visited museums, exhibitions, attended seminars and workshops, met professionals, engaged in architecture and heritage projects, etc. All these factors formed a base for this research study.

During the time that I was in Goa between 2018 – 2020, I spent a few months doing preliminary research in libraries, which have extensive collection of books on Goa's and Portugal history, and architecture. Some of them are:

- Dr. Francisco Luis Gomes District Library, Navelim.
- Krishnadas Shama Goa State Central Library, Panaji.
- Goa College of Architecture library, Panaji.

Several earth houses were visited; and masons, owner-builders, laypeople, etc. were interviewed. Some professionals who were contacted include Architects Tallulah D'Silva (eco-buildings), Noah Fernandes (heritage conservation), Hyacinth Pinto (earth constructions), Ketak Nachinolkar (heritage conservation), among others.

My visit to Portugal was funded by a scholarship from Fundação Oriente, a foundation that supports scientific research between Portugal and countries in the east. During my stay in Portugal, I was mainly based in the village of Mourão, in

Évora district of Alentejo. The two months that I spent in Portugal were rather intense, as I visited several museums, heritage sites, and earth houses; and met architects and other professionals involved with architecture and heritage, especially earth buildings. A detailed report of my itinerary was submitted to 'Fundação Oriente'; it is attached in the annexe.

In both Goa and Portugal, I travelled on less accessible roads to reach some buildings, which permitted me to see parts of my own region, Goa and Portugal as well, which otherwise, I probably wouldn't have had the opportunity to witness.

2.2.2. SELECTION OF STRUCTURES

Various factors were taken into consideration while selecting the earth structures for this study.

- 1) In Goa, the **areas selected** were (a) Salcete — South Goa, which forms a part of the 'Old Conquests'. The 'Old Conquests' constitutes areas occupied by the Portuguese in the first few years of their arrival to Goa, and are hence more influenced by the Portuguese than the other parts of the state (b) Sanguem — South Goa, where it is still possible to find inhabitants building their houses with earth (c) Pernem — North Goa, as the best of Goa's masons are known to hail from this area. Hence, it would be interesting to analyse their houses, which they have built themselves. Though these masons traditionally built with earth, they have evolved with time, and have also built laterite-and-earth or laterite-and-cement buildings.

In Alentejo, the investigation was conducted mainly in the eastern part of the region because of the concentration of rammed-earth constructions there. I mainly covered Évora and Beja districts.

- 2) While structures in Alentejo were chosen from Mariana's study, it was noticed that many rammed-earth buildings in Alentejo had **walls without plaster**, which made it feasible to study the construction materials and building typology employed.

However, this was not the case in Goa, where finding unplastered earthen walls was a challenge. Before, secondary buildings such as outhouses and animal sheds, and the rear wall of some houses were usually left unplastered. However today, many of these structures no longer exist, or rear walls have received a coat of plaster. Plastered walls also make it difficult to identify earthen constructions. However, in order to facilitate the understanding of earth buildings, it was important to locate structures with at least one wall without plaster. Thus, this was a prime criteria while selecting houses in Goa for this study.

As I come from Goa's Salcete region, I was aware of some earth buildings with exposed walls, and I asked around too. As for the other regions covered in this study i.e. Sanguem and Pernem, I visited the region directly, and searched for houses with unplastered walls.

- 3) In both regions, it was a priority to **meet people connected to the selected building** i.e. those who have memories of the house being constructed, have heard such stories from their parents or grand-parents, have lived in the house and contributed to its upkeep, etc. Inputs were also taken from other inhabitants in the region, who had memories and stories related to earthen houses. This methodology permitted unearthing information on material used, local builders, construction techniques, building traditions, maintenance methods, beliefs and practices associated with earth houses, etc.

2.2.3. OTHER CHALLENGES

As I did not speak Portuguese and did not drive, finding my way around Alentejo was quite an adventure. However, the real challenge was when I needed to locate the selected houses and speak to inhabitants regarding them.

Nonetheless, there were locals who showed interest in the research, drove me to the concerned buildings, and translated from Portuguese-to-English, or Portuguese-to-French, and vice-versa. I always kept a copy of Mariana's dissertation, 'Le Pise d'Alentejo' with me, which added credibility when I spoke about my research. I also found it useful to approach the Architect or Archaeologist in the concerned municipality, who often assisted me on site visits, or put me in touch with someone who would.

Thanks to each of them, this research was possible. However, in these situations it was not always possible to spend as much time around each of the structures in Alentejo, and delve as much information, as I would have liked to.

In Goa, I lived the first eight years of my life in an earthen house, and was aware of various cultures and traditions associated with them. I spoke Konkani (Goa's local language), and had my own motorbike. In case of long distances, friends' or hired cars were accessible. I also personally knew some of the owners of the selected houses. These factors made it easier to interview local inhabitants, locate houses, and revisit them, as needed.

2.3. SURVEY METHODOLOGY TO ANALYSES...

In following the survey methodology, two main factors were considered important: (a) to draft information in an accurate and organised manner (b) to record data that would be useful for future research.

In Goa, and sixteen case-studies were conducted. I spent a few hours, sometimes up to a whole day studying each structure.

The buildings were visited along with Lionel Afonso, a student of Goa College of Architecture, who realised the plans, illustrations, and measure drawings, as per my instructions. He too spent a few hours around each structure, and sometimes revisited them, if he felt the need to.

For Alentejo region, I had a list of 40 mud structures surveyed by Mariana, and intended to visit 15 – 20 of them. I managed to visit 23 – 26 buildings, and got in touch with people in connection with 15 of them. This permitted me to update 15 case-studies realised by Mariana in 2000.

In Portugal, as mentioned in the 'Other challenges' section, I had limited time, and spent about an hour or so around each structure. I was usually accompanied by an architect, archaeologist, related professional, and/or local inhabitant, who assisted me with locating the selected houses, language translations, as well as in sharing background information about the region and its buildings.

2.3.1. CASE-STUDY FORMAT

During the course of this research, two case-study templates were used. One case-study format was carried when visiting the building; it contained more details. The second format documented only that information that was relevant to this study. The latter, final template features in this study.

The final template has two versions, one for Goa and the other for Portugal, and they contain minor variations. Both versions are attached in the annexe.

Both templates contain four pages each and include the following categories and sub-categories:

- A. Case-study number.
- B. Identification.
- C. Building data: Chronological data, Technical data, and Typological data.
- D. Care and continuity: Condition assessment, and Maintenance and repairs.
- E. Major changes since 2000 (Portugal only).

A. CASE-STUDY NUMBER

Each case study in Goa was numbered as 'Survey no. 1', 'Survey no. 2', in order of the buildings visited.

In case of the case-studies in Alentejo, the survey number is followed by another number marked in the brackets. The latter number indicates the case-study number as assigned in Mariana's research. Examples: 'Survey no. 2[38]' indicates 'Survey no. 2' in this study and 'Survey no. 38' in Mariana's study; 'Survey no. 12[27]' refers to 'Survey no. 12' in this study, and 'Survey no. 27' in Mariana's study.

B. IDENTIFICATION

In this section of the case-studies, the sub-topics varied slightly in case of the survey done in Goa and Alentejo respectively.

The details for the case-studies in Goa included, 'District', 'Taluka', 'Village', 'Owner(s) / Tenant(s)', 'No. of inhabitants', 'Address', 'Construction techniques(s)', and 'Visited on'.

In case of the survey conducted in Alentejo, the sub-topics contained were 'District', 'Municipality', 'Parish', 'Nearest village', 'Building name', 'Owner(s)', 'Address', 'Directions', 'Construction technique(s)', 'Visited on', 'Revisited on', and/or 'Met concerned person on'.

- 1) The use of 'District', 'Taluka', and 'Village' for the case-study template for Goa; and 'District', 'Municipality', and 'Nearest village' for Alentejo were to permit easy location of the selected structures within the administrative divisions in Goa and Portugal respectively. The sub-point 'Parish' was omitted in the case of Goa because the inhabitants belong to different religions, and were not necessarily associated with a parish, which applies to Catholics only.
- 2) 'Owner(s) / Tenant(s)', 'No. of inhabitants', and 'Address' for the case-studies in Goa; and 'Building name', 'Owners(s)', 'Address', and 'Directions' for those in Portugal indicate details to suited each of the regions.

For the Goa survey, 'Tenants' was noted because some occupants are awaiting ownership status. As explained in the introduction chapter, 'The 'Ganukari' or 'Comunidade' system, and land administration', the Goa Mundkars Protection from Eviction Act 1975 allows tenants to legally claim ownership of the house and plot of land that they have been occupying, if they fulfil the prescribed criteria.

For the case-studies on Alentejo, 'Building name', 'Address', and 'Directions' were specified. In case of the part on Goa, only 'Address' is mentioned because the houses in Goa are assigned numbers for administrative reasons and do not always have a name. The house number makes it easy to locate the house and identify it.

'No. of inhabitants' has not been included in the survey in Alentejo because most houses contained in this study are 'montes' i.e. isolated houses on the top of hillocks, inhabited only during the summers, and used for agricultural reasons. The owner(s) principal house was usually located in a nearby village, where all the family members lived on a more regular basis. This set-up made it uncertain to estimate the exact number of inhabitants. In Goa however, the principal house was usually used for both, residential and agricultural purposes. The houses in Goa often had a loft for stocking agricultural materials.

- 3) The sub-points 'Revisited on' features in the case-studies conducted in Portugal only. 'Visited on' indicates the date Mariana visited the building in 2000, and 'Revisited on' mentions the date I visited the building in 2018.

Sometimes, 'Met concerned person was added. These were cases when the structure was visited a particular date (mentioned in 'Revisited on') and the person who shared information about the building was interviewed on another day.

In case-studies where the structure no longer exists but the people associated with them still live, 'Revisited on' was excluded, and 'Met concerned person on' was included.

- 4) Sometimes mentions such as 'Documented in 2000', 'Documented in 2018', 'As calculated in 2000', 'When visited in 2000', 'When visited in 2018', 'In 2000', 'In 2018', etc. are included in brackets. This is done in order to clearly distinguish the information recorded in 2000 and in 2018, and give a correct sense of time-line.

This section contains four images:

Perspectives of the building	Image 1: Facade of the building and the building's surroundings.	Image 2: Facade of the building and the building surroundings.
Earth used & Typology	Image 3: Close-up of the earth used in the construction of the house.	Image 4: Building typology.

C. **BUILDING DATA**

This category has three sub-divisions: 'Chronological data', 'Technical data', and 'Typological data'. The bullet-points for the sub-categories stayed almost uniform in the surveys conducted in both, Goa and Portugal. They include:

- 1) Chronological data: 'Construction date', 'Builder', 'Original use', 'Present use', 'History of the building', 'Restorations and/or interventions', 'Building in use or not', 'Building at risk', 'Information given by', and 'Other important information'.
- 2) Technical data: 'Base-course', 'Flooring', 'Buttresses', 'Corners', 'Openings', 'Roof type', 'Thickness of exterior walls', 'District architectural details', and 'Observations'.
- 3) Typological data: 'Description of the earth used', 'Dimensions of the 'lifts' (a layer of earth in earthen constructions is referred to as a 'lift'; in this context, if layers exist within a 'lift' they are often simply called 'layers' / 'Dimensions of the rammed-earth block', 'Mortars', 'Plasters, pigments and/or paints', and 'Distinct Characteristics'.

'Dimensions of the 'lifts'' was used in the case-studies on Goa and 'Dimension of the rammed-earth block' was used for those on Portugal, indicating cob and rammed-earth typology respectively.

Generally, four drawings feature in this section:

Image 1: Building plan. In cases where access to the inside of the building was not possible, a roof plan was drawn.	Image 2: Bird's eye view of the building.
Image 3: Facade view or cross-section.	Image 4: Usually an architectural detail.

The drawings for the case-studies done in Goa were realised in 2018-2019 by Lionel Afonse, a Student of Goa College of Architecture. Those for the survey conducted in Portugal were taken from Mariana's research. The latter depicts the building as they were when Mariana visited them in 2000.

In addition, an entire page is dedicated to images. These are usually pictures of the technical aspect of the building, and conservation methods employed for its upkeep.

D. **CARE AND CONTINUITY**

This category comprises two sub-categories: 'Condition Assessment' and 'Maintenance and repairs'. The details included in these remained standard in the case-studies documented in Goa as well as Portugal. They comprise:

- 1) Condition Assessment: 'Damages incurred / problems faced', and 'Observations'.
- 2) Maintenance and repairs: 'Periodic interventions', 'Repairs', 'Observations', 'Challenges faced today', and 'Future plans'.

E. **MAJOR CHANGES SINCE 2000 (Portugal only)**

This category presents what the building looked like in 2000 and more recently, when they were revisited in 2018. It is featured in table form, and contains four images.

In 2000	Image 1	Image 2
In 2018	Image 3	Image 4

As indicated, Images 1 and 2 portray the building in 2000, and Images 3 and 4 were clicked in 2018. The photos clicked in 2000, and then in 2018 were clicked from similar angles to allow pictorial comparison.

In all the tables containing images, when only two images fitted on the page (instead of four, a strip of paper containing the other two images is inserted over it. The paper strip can be flipped allowing for all four images to be viewed.

2.3.2. ANALYSES AND CONCLUSION

An analyses was drawn of the 'local building cultures' and 'conservation approaches' employed in Goa and Alentejo respectively. The data gathered was used to achieve a comparative analyses of the two regions.

II. GOA — INDIA

3. INTRODUCTION — GOA

3.1. GEOGRAPHY

PHYSICAL GEOGRAPHY

India comprises mainland India and its islands. The Indian subcontinent tapers into the Indian ocean with the Lakshadweep Islands in the Arabian Sea on its west, and the Andaman and Nicobar Islands in the Bay of Bengal on its east. It is the seventh largest country in the world with a surface area of 32,87,263sq.km, thus comprising about 2.4% of the world's land. Mainland India stands between latitudes 8° 4' and 37° 6' North, and longitudes 68° 7' and 97° 25' East. It extends to 3,214km from the north to the south and 2,933km. from the east to the west. It has a land frontier of about 15,200km, which it shares with Pakistan, Afghanistan, China, Tibet, Nepal, Bangladesh, Myanmar and Bhutan.^[66] The coastline of mainland India, Lakshadweep Islands, and Andaman and Nicobar Islands equals 7,517km.^[67]

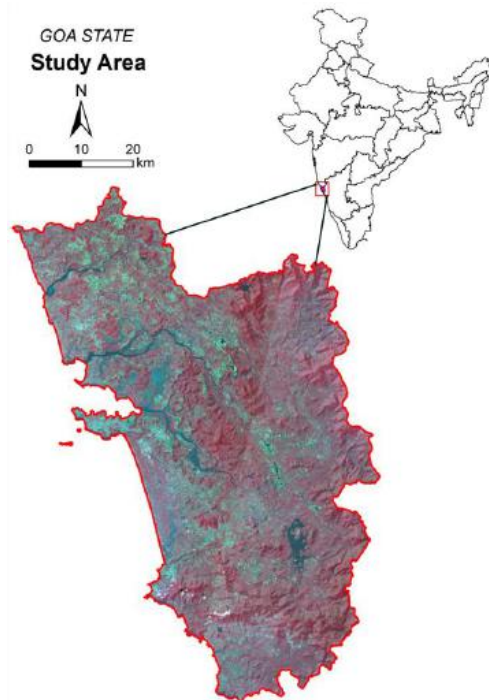

Image 11: Location of Goa in India.

[Source: Singh, LRI Technology - A Base for Sustainable Agriculture, p.7]

India can be geographically divided into: (1) the Himalayan Mountain Range (2) Great Plains of North India (3) Peninsular Plateau (4) Coastal plains (5) islands.

India is the world's largest democracy. For administrative purposes, it is divided into 29 states and 7 Union Territories for purpose of administration (in 2018).^[68] States and Union Territories are divided into districts and sub-districts. According to their regions, sub-districts are referred to as 'mandals', 'tehsils', 'tahsils', 'taluks', 'talukas', 'circles', 'blocks', and 'sub-divisions'. These further constitute cities, towns, clusters of villages or villages.^[69] Towns and villages are further divided into wards.^[70] The President is the constitutional head of the country; he is advised by a Council of Ministers headed by the Prime Minister. At the state level, the Governor is the head, advised by a Council of Ministers headed by the Chief Minister.^[71] Towns and cities are administered by municipalities. Villages are administered by 'Gram Panchayats', which constitutes a council of ministers headed by the 'Sarpanch'.

Goa, the region selected for this study is India's smallest state located on the west coast along the Arabian Sea. The coastal stretch on which Goa is situated is called the Konkan Coast. Along with its islands, Goa has a total land area of 3,702km². It shares its borders with the state of Maharashtra along the north and Karnataka along the south.^[72]

⁶⁶ Khullar, *India: A Comprehensive Geography*, p.1,4

⁶⁷ www.archive.india.gov.in/knowindia/profile.php?id=2

⁶⁸ www.india.gov.in/india-glance/profile

⁶⁹ www.censusindia.gov.in/Census_And_You/Administrative_division.aspx

⁷⁰ Chandramouli, *Census of India 2011 Administrative Atlas of India*, p.iii

⁷¹ www.india.gov.in/topics/governance-administration

⁷² www.goa.gov.in

Goa's topography can be divided longitudinally, except in the south:^[73]

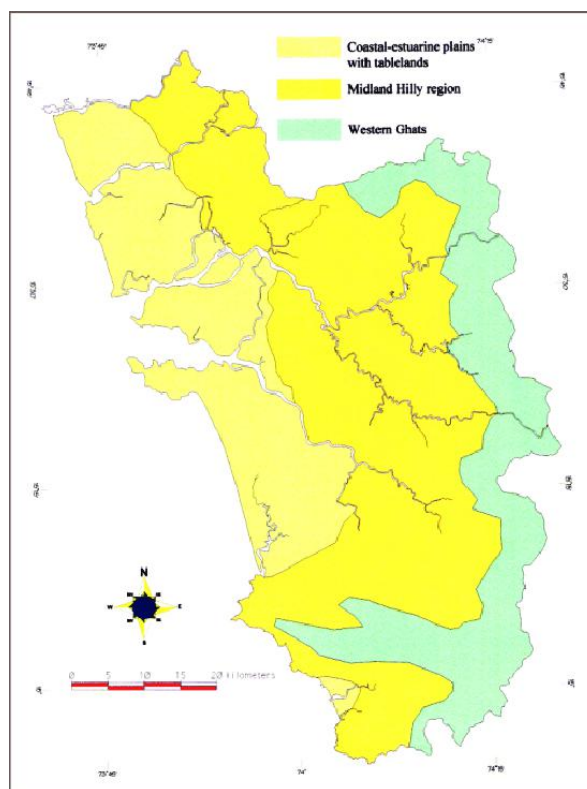

Image 12: Physiographic divisions of Goa.

[Source: Mascarenhas, *Natural Resources of Goa: A Geological Perspective*, p.12]

- 1) The Western Coastal-estuarine plains with tablelands: includes low-lying areas such as stretches of sandy beaches, estuarine mudflats, khazan lands, mangroves, salt pans, fields and settlement areas. The two largest estuaries are Zuari and Mandovi. Though the plains are generally wider in the north than in the south, all along the coast, the beaches are interrupted by cliffs formed by laterite topped plateaus and tablelands. In Canacona and Quepem, along the southern coast, the estuary plains are narrower and there are hills and mountains.
- 2) Hilly Midlands: are hills of about 100-600m in height. They form the stretch that lies between the coastal area and adjoining plateau, and the higher altitudes of the Western Ghats.
- 3) Western Ghats or Sahyadris: comprise higher and steeper ranges of 600-1000m. These occur in the eastern and southern parts of Goa. The Western Ghats is classified as a Natural World Heritage Site.^[74] The rivers in Goa originate in the Western Ghats and empty into the Arabian Sea.

THE 'GANVKARI' OR 'COMUNIDADE' SYSTEM, AND LAND ADMINISTRATION

A prominent aspect of pre-Portuguese Goa is the 'Gaunkari' system, which ensured that its villages were self-sufficient and autonomous (except in and around the Sattari region, where it was not practised).^[75] The 'Gaunkari' system is an agro-socio-economic institution upholding that ownership of land in the village did not belong to individuals, but jointly to the villagers.^[76] Early settlers in Goa believed that land belonged to God and then the king, and though the village communities jointly cultivated the land for their sustenance, it was against their conscience to own it or sell it.

The Portuguese formalised this system, renamed it 'Comunidade' system, and legalised it by inscribing the Code of Comunidades (1732).^[77] Land was demarcated for housing, agriculture, forests, etc. However, when this was being done it was infiltrated by hierarchy, caste and occupation. Within this system, the 'Bhaattkar-Mundkar' system took form. 'Bhaattkar' refers to landlord and the 'mundkar' is the tenant. In exchange for staying on the 'bhaattkar's' land, the 'mundkar' would maintain a piece of land or offer domestic and agricultural services to the 'bhaattkar'. The 'mundkar' would in turn get a small portion of produce.^[78]

The 'Gaunkari' or 'Comunidade' system permitted for good care of the village and its infrastructure. It created and maintained canal irrigation systems and other water bodies through villages and plantations; leased lands for tilling;

⁷³ Mascarenhas, *Natural Resources of Goa: A Geological Perspective*, p.11-14

⁷⁴ www.whc.unesco.org/en/list/1342 (accessed June 3, 2019)

⁷⁵ Borges, ed., *Goa and Portugal: History and Development*, p.138

⁷⁶ Khedekar, *Goa: Land, Life and Legacy*, p.68

⁷⁷ *Ibid.*, p.68

⁷⁸ Borges, ed., *Goa and Portugal: History and Development*, p.139-140

monitored services by carpenters, potters, etc; supervised festivals and rituals; ran the village school; etc. Thus, a strong and efficient village system existed.^[79]

The 'Gaunkari' or 'Comunidade' system also participated in the village administration. A 'Hawaldar', who was a representative of the king was meant to keep a watch on the village and any dispute was to be reported to him first. However, if the problem was not too big, he would solve it with help of the village elders or a 'Bhous' or 'Mand', who were part of the Ganvkari system. As Portuguese administration took over, the Portuguese government appointed a 'Regidor' to solve disputes.^[80]

Today, Goa is part of the Indian territory, and though the 'Ganvkari' or 'Comunidade' system still exists, it is fading away. Recent laws demand that 'Ganvkari' or 'Comunidade' land be taken over by the village administrative division, and there are laws to protect the interests of tenants i.e. 'mundkars'. The Goa Mundkars Protection from Eviction Act 1975 gives tenants the right to claim ownership of the house and plot of land their family has been living on for generations, provided they have a legal 'mundkar' status. In this case, the landlord i.e. 'bhaattkar' is obliged to grant ownership of that plot or another one in the vicinity to the occupants.^[81]

Today, as per the Indian administration, Goa is divided into North Goa and South Goa districts for administrative reasons. These are subdivided into 12 'talukas', which include 14 towns administered by municipalities, and 334 villages managed by 191 village 'panchayats'.^[82] Villages are further divided into wards or 'vados'.^[83]

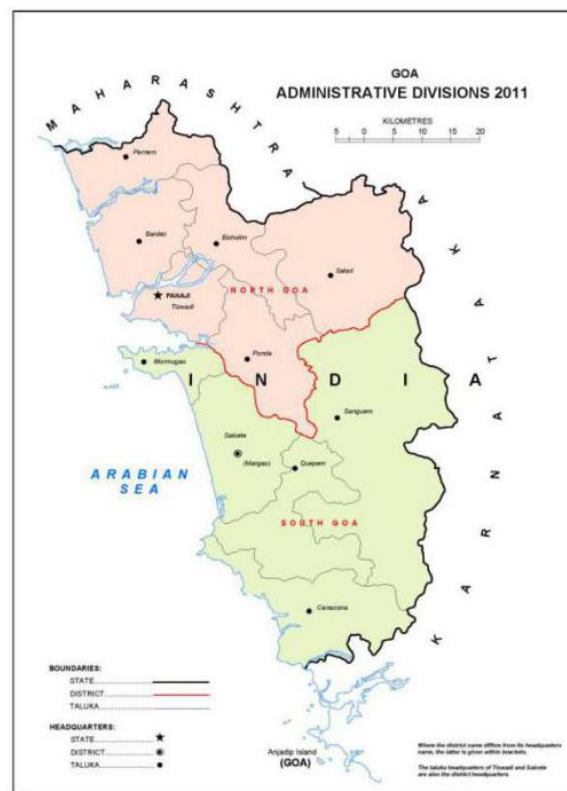

Image 13: Goa is divided into two districts (North Goa and South Goa), which are further subdivided into 12 'talukas'.
[Source: <http://vlist.in/map/30.html> (accessed on January 16, 2020)]

Village lands are now in the process of being entrusted to the 'panchayat', and there is provision for 'mundkars' to take ownership of the piece of land that they have been occupying for generations. Though the 'Gaunkari' or 'Comunidade' system still exists, it is scarcely seen now. Existing land planning is ignored and land constructions are on a rise.

POPULATION AND RELIGION

The tribal population includes the Gaudes, Kunbis and Gaulys/Dhangars. Later came the Negritos, Australoids, Dravidians, and Indo-Europeans in succession, which largely comprises today's population. Goa's population today is mainly of Aryan Dravidian origin, who had settled in other parts along the west coast.

⁷⁹ Khedekar, *Goa: Land, Life and Legacy*, p.70

⁸⁰ *Ibid.*, p.144

⁸¹ Merchant, "Tenant cannot become mundkar: HC," *The Times of India*, November 27, 2012.

⁸² Directorate of Planning, Statistics & Evaluation, Government of Goa, *Goa Economy in Figures – 2017*, p.2

⁸³ Khedekar, *Goa: Land, Life and Legacy*, p.138

Early Goan settlers worshipped nature or their village deities. When the Portuguese arrived in Goa, there were also Muslims, Jews, and other settlers as well.^[84] However, the 16th Century Portuguese rule in Goa saw the inquisition, when people were forced to convert to Christianity.^[85] Temples were destroyed and replaced with churches. Those who converted were favoured for employment^[86] and the women were given equal rights to men.^[87] By the 19th Century, religious freedom was re-established, and the Uniform Civil Code ensured equal rights for all citizens irrespective of religion (Goa is the only Indian state to have this code). In spite of the long oppression, the Hindus (including those Christians reconverted to Hinduism) continued to dominate the population, followed by Christians and Muslims.

Today, some Goan Christians still take offerings to Hindu deities because they are the deities of their ancestors. Similarly, some Hindus come to churches because churches are built on premises which were once a common worship place. This bond is unique to Goa.^[88] It is even common to see Christian crosses built near streets, sometimes next to Hindu houses without inhibition. Neighbours share close bonds irrespective of religion as most Goans Christians were once Hindus.^[89] A complex caste system, based on religion and family occupation thus socio-economic existed among both, the Hindus and Christian converts but is hardly practised today.^[90]

Goa's population, as per the 2011 census was estimated at 1,458,545 and population density was 394. Hindus constituted 64.68%, Christians 29.86%, and Muslims 5.25%. Literacy rate was estimated at 88.7%.^[91] In more recent years, around 0.2 million i.e. 35% of the total population constitute immigrants who hail from around India.^{[92][93]} Immigration is due to need for semi-skilled labour.^[94] The most populous cities are Mormugao, Margao, Mapusa and Panaji, which is the capital city.^[95]

LANGUAGE

The official language of Goa is Konkani, and 'Devanagari' is the official script; Marathi is permitted for official purposes (Official Language Act, 1987). There are about seven dialects are spoken in Goa,^[96] which are influenced by and include words from Sanskrit, Marathi, Kannada, Portuguese and English languages.^[97] Konkani is also written in five scripts: Devanagari (popular among Goans and Marathis, especially Hindus); Roman (Goans, especially Catholics);^[98] Perso-Arabic (Goan muslims); Kannada (Goan origin communities in Karnataka); Malayalam (Goan origin communities in Kerala).^{[99][100]} In addition, English and Portuguese (small minority) is also spoken.

ECONOMY

The main industries in Goa include tourism, pharmaceuticals and fishing.^[101] Mining, which until recently was Goa's second biggest industry has received a severe set-back because of environmental reasons.^{[102][103]} Agriculture, also one of Goa's main industries has seen a decline over the years. When the Portuguese left Goa in 1961, 70% of the population was involved in agriculture, which has now reduced to 16.6%.^[104] Goa's economy changed from agrarian to a remittance-based, towards the end of the 19th Century as inhabitants began seeking employment in other parts of India and the world, as well as on merchant ships.^[105] The number of people choosing to migrate and the remittances continue to increase even in the 21st Century. Though the Indian economy on the whole is not dependent on international remittances, Goa (including Kerala, Punjab) are among the top remittance-dependant economies of the world.^[106] As per 2016-2017 survey, Goa's Net state domestic product (NSDP) per capita income is highest in India i.e. INR 3,75,554 (approximately EUR 4,690).^[107]

⁸⁴ Fjeld, *The Jewish Martyrs of Old Goa*

⁸⁵ Borges, ed., *Goa and Portugal: History and Development*, p.290-291

⁸⁶ Rangel-Ribeiro, ed., *Goa Aparanta – Land Beyond the End*, p.202

⁸⁷ Pandit and Mascarenhas, *Houses of Goa*, p.21

⁸⁸ Rangel-Ribeiro, ed., *Goa Aparanta – Land Beyond the End*, p.200

⁸⁹ Ibid., p.104

⁹⁰ Khedekar, *Goa: Land, Life and Legacy*, p.102-113

⁹¹ www.census2011.co.in

⁹² www.goa.gov.in

⁹³ Gama, *Migration from Goa: Factors, Household, Characteristics and Consumption Expenditure Inequalities*, p.112

⁹⁴ www.nri.goa.gov.in

⁹⁵ www.census2011.co.in

⁹⁶ Rangel-Ribeiro, ed., *Goa Aparanta – Land Beyond the End*, p.73

⁹⁷ Khedekar, *Goa: Land, Life and Legacy*, p.10

⁹⁸ Gune, *Gazetteer of the Union Territory Goa, Daman and Diu*, p.221

⁹⁹ Sardesai, "Mother Tongue Blues", www.india-seminar.com/2004/543/543%20madhavi%20sardesai.htm (accessed June 4, 2019)

¹⁰⁰ https://en.wikipedia.org/wiki/Konkani_language#Scripts

¹⁰¹ www.ibef.org

¹⁰² www.business.mapsofindia.com, *Goa Economy*

¹⁰³ Goa Foundation, "Goa mining ban: The truth that lies beneath", *The Economic Times* (India), April 10, 2018,

<https://economictimes.indiatimes.com/blogs/et-commentary/goa-mining-ban-the-truth-that-lies-beneath/>

¹⁰⁴ Gama, *Migration from Goa: Factors, Household, Characteristics and Consumption Expenditure Inequalities*, p.180

¹⁰⁵ Tumble, *India Moving: A History of Migration*

¹⁰⁶ Tumble, *Remittances in India: Facts & Issues*, p.3-4, 14, 17-17

¹⁰⁷ www.mospi.gov.in

3.2. GEOLOGY

3.2.1. LITHOLOGY

India can be widely divided into two contrasting geological regions.^[108]

- 1) Peninsular region: includes Peninsular India, Meghalaya Plateau in the north-east and Kuchchh-Kathiawar region in the west. There has been subjected to minimum tectonic forces since the Cambrian period (600 million years ago) and remains one of the oldest landmasses in the world.
- 2) Extra-Peninsular region: includes the Himalayas, Ganga Plain, and Andaman and Nicobar islands. It is prone to tectonic activities and is a young terrain.

India's rock formation history goes back to Pre-Cambrian times i.e. prior to 600 million years ago. Studies by the Geological Survey of India (GSI) have classified India's rock formation into four periods:^[109]

- 1) Archaean rock system: are the world's oldest rocks and consist of gneiss and schists (4000 million years ago) and metamorphosed sedimentary rocks (4,000 – 1,000 million years ago, Pre-Cambrian period).
- 2) Purana rock system: is particularly rich in building quality quartzites and limestones. It includes sedimentary rocks on underlying Archaean rocks (1,300 – 600 million years ago, Pre-Cambrian).
- 3) Dravidian rock system: shows presence of clays, slates, quartzites, grits, sandstones, limestones, coal, etc. It is mainly present in the Extra-Peninsular region (600 – 300 million years ago, Palaeozoic period).
- 4) Aryan rock system: is particularly rich in coal, as well as gravel and alluvial deposits. The igneous Deccan Trap and Peninsular coastline belong to this category (250 million years ago – recent times, Mesozoic period onwards).

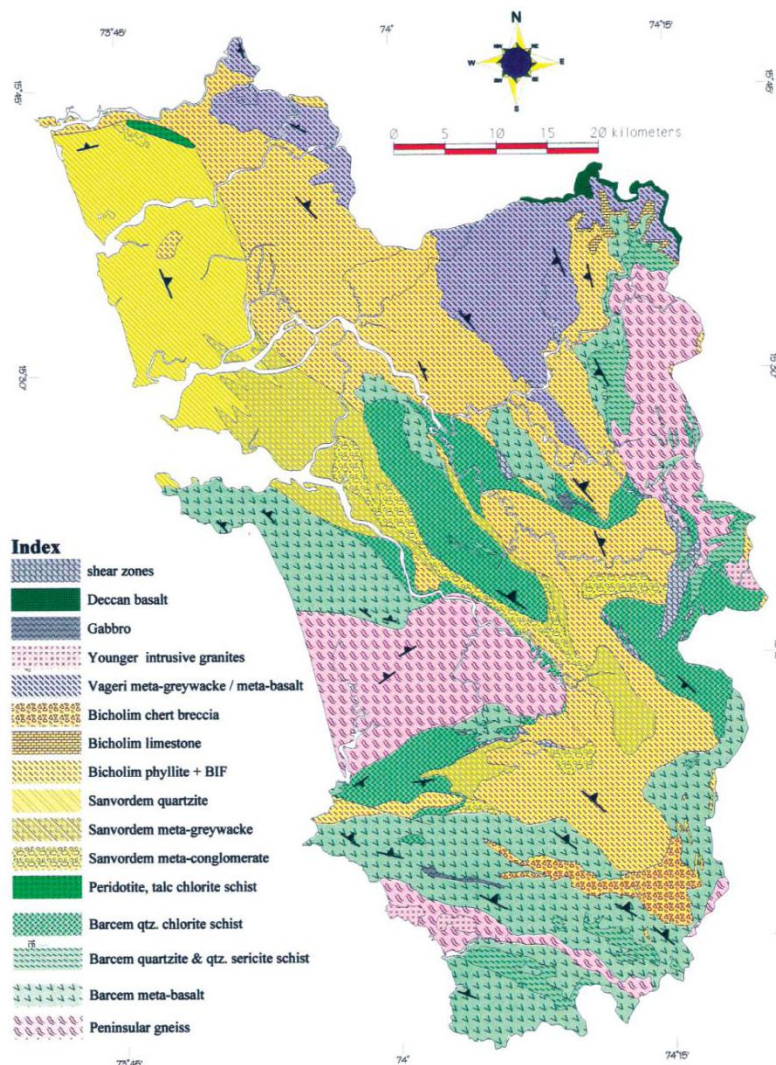

Image 14: Geological map of Goa.

[Source: Mascarenhas and Kalavampara, eds., Natural Resources of Goa: A Geological Perspective, p.15]

¹⁰⁸ Khullar, *India: A Comprehensive Geography*, p.30,46

¹⁰⁹ *Ibid.*, p.29-38

Goa mainly constitutes greenschist metamorphic rocks on a base of gneiss with occasional mafics, ultra-mafics and granites (Pre-Cambrian). Other major lithological compositions include laterite rocks and soil (sub-recent Mesozoic period), and alluvium and sand along coast and estuaries (recent Mesozoic period). The Deccan Trap fringes only the north-eastern border of the state.^{[110][111][112]}

A layer of laterite rock is found over almost all rock types in Goa, though there are places with very less or no laterite at all.^[113] The word 'laterite' comes from a Latin letter and means 'brick'.^[114] It is usually red in colour. It is a residual weathered rock layer usually found in wet, tropical regions. Typically, laterite has a thickness of 8 – 12m and is seen exposed on hills and plateaus. Usually underneath this, there is a layer of laterite gravel, below which sometimes is a layer of lithomarge (a clay). Gravel and lithomarge may vary in thickness. The original igneous or metamorphic rocks form the base layer.^[115]

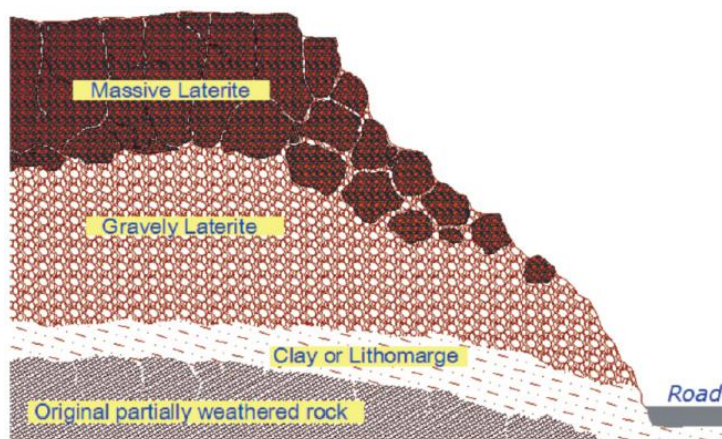

Image 15: A schematic section of a typical laterite profile.

[Source: Mascarenhas and Kalavampara, eds., *Natural Resources of Goa: A Geological Perspective*, p.18]

These surface layers of laterite make it difficult to view other rock types. However, granite is seen well exposed in South Goa.^[116] The Deccan trap has basalt and a thin laterite cover.^{[117][118]}

¹¹⁰ Mascarenhas and Kalavampara, eds., *Natural Resources of Goa: A Geological Perspective*, p.14,16,19

¹¹¹ Gune, *Gazetteer of the Union Territory Goa, Daman and Diu*, p.17

¹¹² Dessai, *Geology and Mineral Resources of Goa*, p.5

¹¹³ Gune, *Gazetteer of the Union Territory Goa, Daman and Diu*, p.21

¹¹⁴ Khullar, *India: A Comprehensive Geography*, p.168

¹¹⁵ Mascarenhas and Kalavampara, eds., *Natural Resources of Goa: A Geological Perspective*, p.19

¹¹⁶ *Ibid.*, p.19

¹¹⁷ Gune, *Gazetteer of the Union Territory Goa, Daman and Diu*, p.21

¹¹⁸ Mascarenhas and Kalavampara, eds., *Natural Resources of Goa: A Geological Perspective*, p.19,39-40

3.2.2. PEDOLOGY

Just like its lithology, India's soils can be broadly classified into:

- 1) Soils of peninsular India: These are formed by the decomposition of rocks that lie beneath. As they originate in the very place they are found, they are called 'sedentary soils'.
- 2) Soils of extra-peninsular India: These are formed by the deposits of rivers and winds. They are usually deep and fertile. As they are brought in by depositional activity, they are referred to as 'transported or azonal soils'.^[119] Soils in the peninsular are older than the ones in the plains of extra-peninsular India.^[120]

The soils in India are very varied owing to the country's diverse geographical conditions. The Indian Institute of Agricultural Research (ICAR) has however classified the soils of India into eight major types: alluvial soils, black soils, red soils, laterite and lateritic soils, forest and mountain soils, arid and desert soils, saline and alkaline soils, peaty and marshy soils.^{[121][122]}

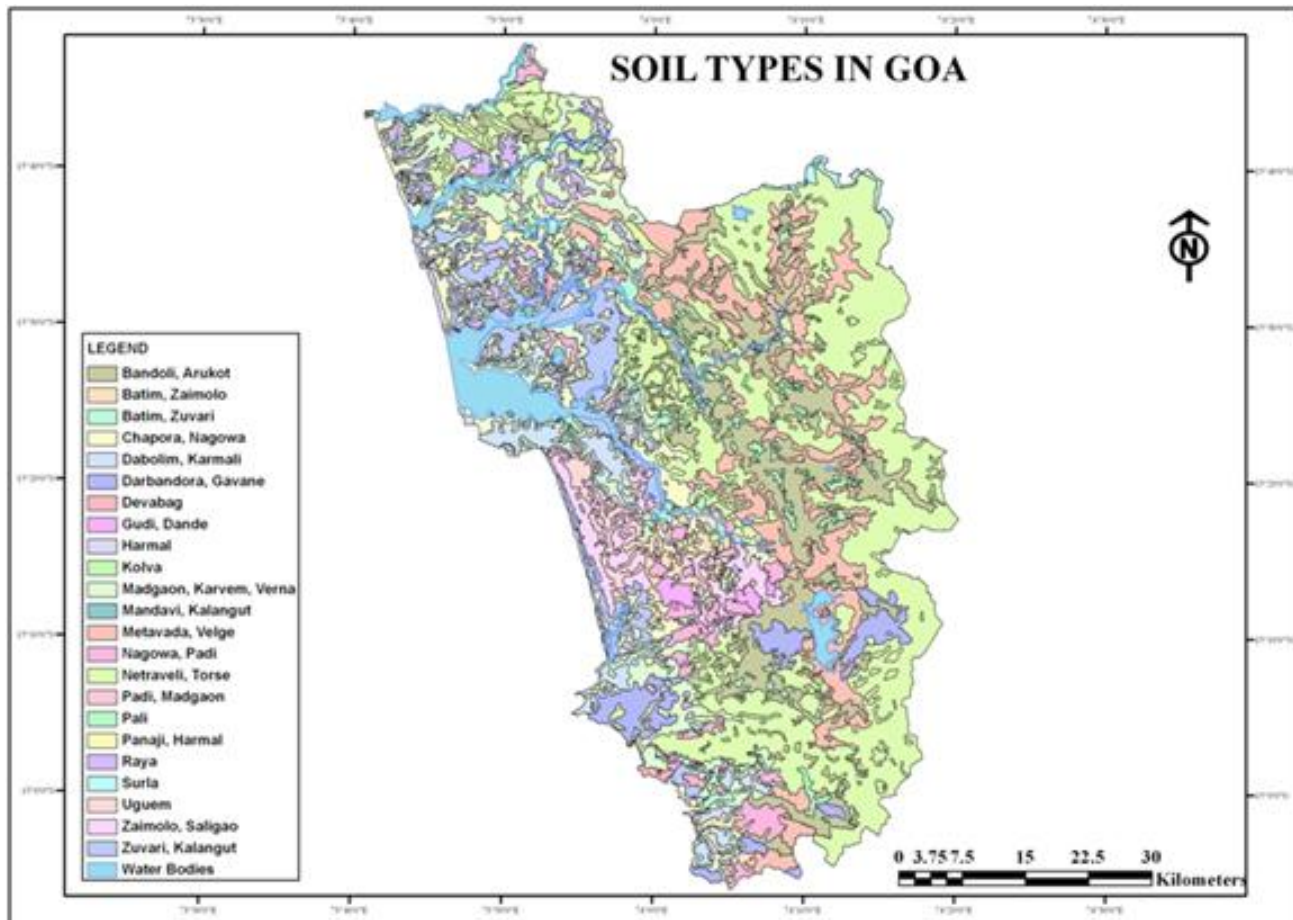

Image 16: Soil map of Goa.

[Source: Unknown]

Though the soils of Goa could fit into several of these soil categories, the majority of Goa's soils are identified as 'lateritic' (81%) or 'loams'.^{[123][124]} Lateritic soils are typical of moist tropical regions. They are generally less fertile but some lateritic types react well to agriculture when treated with manures and irrigation. The distinct characteristic of lateritic soils is that they form quality building material. These soils can be dug easily but become hard and strong when exposed to air. As they are also less likely to weather, they provide houses that last.^[125]

The majority of the **lateritic soils** of Goa are reddish in colour.^[126] They are rich in iron and aluminium oxides, and are briefly categorised into (1) 'latosolic' i.e. 'red residual soils' or (2) 'oxisols' i.e. 'ferralitic soils'.^{[127][128]} They mostly vary

¹¹⁹ Khullar, *India: A Comprehensive Geography*, p.165

¹²⁰ *Ibid.*, p.169

¹²¹ Saxena, *Indian and World Geography*, p.52-57

¹²² Khullar, *India: A Comprehensive Geography*, p.165

¹²³ Singh, *Newsletter, ICAR Research Complex for Goa*, p.1

¹²⁴ Dessai, *Geology and Mineral Resources of Goa*, p.291-292

¹²⁵ Khullar, *India: A Comprehensive Geography*, p.168

¹²⁶ Singh, *Newsletter, ICAR Research Complex for Goa*, p.1

¹²⁷ Khullar, *India: A Comprehensive Geography*, p.168

from sandy-loam to silt-loam texture, and are well drained and highly acidic. Goa's soils are rich in humus as well as minerals, yet they are conducive for crops.^[129]

These soils in Goa are classified into three horizontal divisions:^[130]

- 1) Horizon 'A': comprises decomposed plant debris, and is poor in clay. It has a greyish-brown colour and is mostly quite well developed.
- 2) Horizon 'B': is brown or red-brown. Sometimes, you can see colour mottling and concretion in texture. Between horizon 'A' and 'B', there is a 'middle zone' of mottled and ochre-coloured soil.
- 3) Horizon 'C': includes fewer concretions and red mottling, which lessen with depth.
- 4) The thickness of these horizontal layers may vary. In case of regions where matured soil profiles exist, each layer may be tens of centimetres thick. It is common to find profiles that are more than 3m deep.

Most of Goa's soils along its coastal plains and those formed on granitic gneisses are **loams**. Loam includes sand, silt and clay in appropriate proportions of 40:40:20 respectively. Depending on the proportions, it is called sandy-loam, silty-loam, clay-loam, sandy-clay-loam, silty-clay-loam, and loam.^[131]

The soils along Goa's coastal plains and the bordering hinterlands constitute some of the best developed profiles. These are categorised into four basic categories based on where they are found.^[132]

- 1) Coastal alluvium and beach sand: This sand is locally called 'ker'. It is a pale-greyish-brown, sandy and alluvium soil. On the surface it is sandy and light textured. Gradually it grades into sandy-clay-loam to sandy-clay or clay-loam and is heavily textured. The profiles of these soils vary from well-drained to moderately-well-drained, and deep to very deep.
The horizon 'A' is grey when dry and grey-brown when moist. It is 20cm thick.
Horizon 'B' is yellowish-brown when dry and grey when moist. It 20-40cm thick.
These soils are found in the 'talukas' of Pernem, Bardez and Salcete.
This soil bears similarities to the 'Kolva' series. (*Refer 'Soil Legend – Goa' in the annexe*)
- 2) Sediments on tidal flats: The top layer of these soils are locally called 'khazans' or 'cantor'.
The horizon 'A' is pale-yellowish-brown to yellowish-brown when dry and olive-brown when moist. It is also hard when dry, firm when moist, and sticky and plastic when wet. These soils comprises silty-clay and silty-clay-loam, which shades into a dark grey. It has a maximum thickness of 15-20cm.
Horizon 'B' is dark-grey-brown when both dry and wet. Its thickness varies from 13-96cm.
This soil could correspond to the the 'Mandavi' series. (*Refer 'Soil Legend – Goa' in the annexe*)
- 3) Soils on granitic gneisses:
Horizon 'A' is light-brownish-grey when dry and very-dark-brown when moist. It is also slightly hard when dry and friable when moist. The soil profile varies from deep to very deep with a thickness that varies between 22-25cm.
These soils have a moderate-medium-granular texture, light on the surface and heavy in horizon 'B'.
Horizon 'B' is classified by coarse-sandy-loams to fine-sand-loams. It is 22-146cm thick.
This soil could correspond to the 'Gudi' series. (*Refer 'Soil Legend – Goa' in the annexe*)
- 4) Soils on Colluvium:
Horizon 'A' varies from brown when dry to dark-brown when moist, and silty-clay-loam to silty-clay. It has a maximum thickness of about 15cm.
Horizon 'B' is reddish-brown when dry and yellowish-red when moist. It is a gravelly-silty-clay-loam soil. These soils are very deep with a varying thickness of 15-115cm. They are seen on gentle slopes in higher altitudes, as well as in the lower areas of South Goa such as Neturlim , Rivona and Canacona.
This soil could correspond to the the 'Netravali' series. (*Refer 'Soil Legend – Goa' in the annexe*)

The soils of Goa have been classified into 25 mapping units and 32 'soil series' according to its location, classification, associated soils, properties, and potential and constraints for crop production. This 'Soil legend of Goa' has been extracted from 'Soils of Goa for Optimising Land Use' (C.S. Harindranath et al., ICAR, 1999) and is included in the annexe.

¹²⁸ Dessai, *Geology and Mineral Resources of Goa*, p.291

¹²⁹ Singh, *Newsletter, ICAR Research Complex for Goa*, p.1

¹³⁰ Dessai, *Geology and Mineral Resources of Goa*, p.291-292

¹³¹ *Ibid.*, p.292

¹³² *Ibid.*, p.295-299

3.2.3. SEISMIC RISK

According to the Bureau of Indian Standards (BIS), India is divided into four earthquake zones, which corresponds with the internationally accepted Modified Mercalli (MM) intensity scale.^[133]

Seismic Zone (BIS)	Intensity on MM scale
Zone II (low intensity).....	VI (or less)
Zone III (moderate intensity).....	VII
Zone IV (severe intensity).....	VIII
Zone V (very severe intensity zone).....	IX (and above) IX

Seismic Zone Map of India: -2002

About **59 percent** of the land area of India is liable to seismic hazard damage

Zone	Intensity
Zone V	Very High Risk Zone Area liable to shaking Intensity IX (and above)
Zone IV	High Risk Zone Intensity VIII
Zone III	Moderate Risk Zone Intensity VII
Zone II	Low Risk Zone VI (and lower)

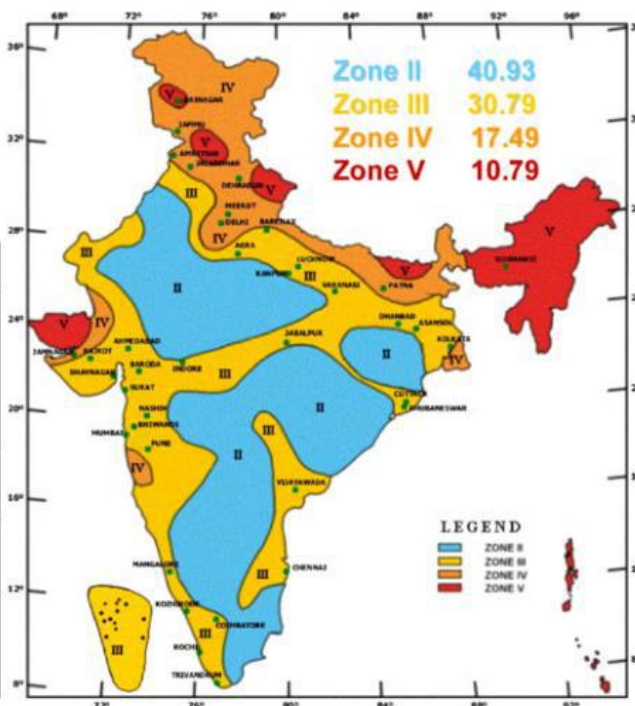

Image 17: Seismic intensity map of India.

[Source: National Institute of Disaster Management, Government of India, *Seismic Zoning*, https://nidm.gov.in/safety_earthquake.asp (accessed June 20, 2019)]

Based to recorded history, intensity and frequency of earthquakes, studies show that 59% of India's landmass is prone to earthquakes of various magnitudes. 11% is categorised as zone V, 18% as zone IV, 30% as zone III, and the rest is Zone II.^[134]

The Indian subcontinent is subjected to earthquakes or the effects of earthquakes occurring in neighbouring regions. Recent major earthquakes of more than M8 that affected the India include that in Sumatra – Indonesia (2004, M9.1), Assam (1950, M8.6), Andaman Islands (1941, M8.1), Bihar-Nepal (1934, M8), Assam (1897, M8).^[135] The Andaman Islands (1941) and Sumatra (2004) earthquakes were accompanied by tsunamis.

Goa comes under zone III i.e. the moderate intensity zone, and is categorised as a low hazard region.^[136] Records of earthquakes and tremors experienced in Goa include: (1) Killari – Maharashtra earthquake (September 1993, M6.2), when strong tremors were experienced in neighbouring regions including Goa. (2) Canacona – Goa earthquake (January 2004), when a series of tremors were experienced in parts of Canacona taluka of South Goa; the epicentre is unknown but seems to be within the Canacona region.^[137]

¹³³ Ministry of Earth Sciences, Government of India, *Earthquake Prone States*, https://www.moes.gov.in/writereaddata/files/LS_US_1780_26072017.pdf (accessed June 20, 2019).

¹³⁴ National Institute of Disaster Management, Government of India, *Seismic Zoning*, https://nidm.gov.in/safety_earthquake.asp (accessed June 20, 2019).

¹³⁵ National Institute of Disaster Management, Government of India, *Designing Safe House in an Earthquake Prone Area*, https://nidm.gov.in/safety_earthquake.asp (accessed June 20, 2019).

¹³⁶ Amateur Seismic Centre, *Karnataka & Goa*, <http://asc-india.org/maps/hazard/haz-karnataka-go.htm> (accessed June 20, 2019).

¹³⁷ Amateur Seismic Centre, *Earthquakes in Karnataka & Goa*, <http://asc-india.org/seismi/seis-karnataka-go.htm> (accessed June 20, 2019).

3.3. CLIMATE

The climatic conditions in India vary vastly across its wide landmass. The cold temperatures of the Himalayas in the north, hot deserts of Rajasthan in the west, tropical monsoons of the south, etc. The Tropic of Cancer runs through the middle of India, thus northern part falls in the temperate zone and southern in the tropical zone. However, the Himalayas in the north, block the cold air that comes from Central Asia, thereby reducing expected winter temperatures in India by 3°C – 8°C. So the part of India that lies to the south of the Himalayas is considered to be a tropical region. In the south, as Peninsular India is flanked by the Arabian Sea on the west and the Bay of Bengal on the east, it receives a tropical monsoon climate. Thus, India is par excellence, a tropical monsoon country.^[138]

Goa is located in Southern India, along the western coast i.e. the Arabian Sea and so, Goa is a tropical monsoon region. It experiences a hot and humid climate. There are three main seasons: summer from February to May (19°C – 36°C), monsoon from June to September (24°C – 30°C), and post-monsoons from October to January (24°C – 35°C).

Specific weather trends in Goa have been observed based on data collected during the period of 2002 – 2015. (Weather trends of Last Fourteen Years (2002 – 2015) at ICAR – Central Coastal Agricultural Research Institute, Old Goa, 2016).

Generally, **temperature**^[139] gradually increases from January to May and September to October. It decreases from May to August and October to December. From 2002 – 2015, the highest temperature was observed in May (35.9°C) and lowest in January (18.9°C). However, the difference between minimum and maximum temperature varied between 2002 – 2007 and 2008 – 2015. From 2002 – 2007, temperature at its minimum (9.2°C) and maximum (10.3°C) differed by only 1.1°C. From 2008 – 2015, it increased as temperature at its minimum (10.7°C) and maximum (13.4°C) differed by 2.7°C.

Goa's average yearly Mean Monthly Morning Relative **Humidity** (RH1) ranges from 85% – 89%, and Mean Monthly Afternoon Relative Humidity (RH2) from 57% – 63%. As per records, RH1 stays higher than RH2 throughout the year.^[140]

It is generally hot and sunny throughout the year in Goa. So the **monsoons**^[141] are refreshing. Pre-monsoon showers are usually experienced in May (66mm), heavy showers in June (833mm) and July (960mm), and rainfall declines from August (668mm) to November (19mm). The monsoon months from June to September experience most i.e. 91% of the total rainfall Goa receives during the year. During this period of 2002 – 2015, Goa experienced an average annual rainfall of 2,678mm. A steep increase in rainfall was recorded in 2010 (3,510 mm), which was the highest in the years from 2002 – 2015. The lowest rainfall during this term was in 2002 (2,027mm).

The records from 2002 – 2015 also show that monsoon months experienced slightly lower temperatures, less sunshine and steep drop in evaporation.^{[142][143][144]} On the contrary, RH1 and RH2 were observed to be at their highest i.e. Above 90% during the monsoon months.^[145] Wind speed too was highest during the monsoons of June and July (4.2km/h).^[146]

Goa has faced very few major climatic hazards. However, climate change coupled with inefficient land planning in the state has of late, resulted in damage and destruction. In 2017, Cyclone Ockhi, which originated in the Bay of Bengal off the east coast of India, resulted in high tides on the west coast, causing flooding of beach shacks in Goa and subsequent soil erosion.^[147] In 2019, Goa experienced floods, which effected several villages in the state.^[148] Temperatures too have been rising every year in Goa.

¹³⁸ Khullar, *India: A Comprehensive Geography*, p.94

¹³⁹ Mahajan et al., *Weather trends of Last Fourteen Years (2002 – 2015) at ICAR – Central Coastal Agricultural Research Institute, Old Goa*, p.4-5

¹⁴⁰ *Ibid.*, p.7

¹⁴¹ *Ibid.*, p.13-14

¹⁴² *Ibid.*, p.4

¹⁴³ *Ibid.*, p.10

¹⁴⁴ *Ibid.*, p.16

¹⁴⁵ *Ibid.*, p.6

¹⁴⁶ *Ibid.*, p.8

¹⁴⁷ NT Network, "Disaster management meet today to assess damage," *Navhind Times*, December 5, 2017, <http://navhindtimes.in/disaster-management-meet-today-to-assess-damage/> (accessed August 22, 2019)

¹⁴⁸ PTI, "Heavy rains cause flooding in Goa, several evacuated," *The Hindu*, August 6, 2019, <https://www.thehindu.com/news/national/other-states/heavy-rains-cause-flooding-in-go-a-villages-several-evacuated/article28830981.ece> (accessed August 22, 2019)

3.4. EARLY GOANS AND HISTORY OF MIGRATION

There are records that Goans migrated as early as 500BC to other parts of India and the world to establish trade links. Two major events that saw Goans migrate in big numbers were the 16th Century religious inquisition and the 17th Century decline in economic opportunities.^[149] In the 21st Century, the lack of economic opportunities continues to be a major reason the people of Goa choose to migrate. The Goan diaspora can today be found in almost every major city in the world.

Pre-Portuguese:

In the 11th-12th Century, Goans mainly moved to **Karnataka**, and in 13th Century to **Kerala**.^[150]

16th-17th Century:

After the Portuguese arrived, and the Inquisition began in 1560, both Hindu and Christian families migrated to **Kerala** to escape the religious persecution.^{[151][152]}

In the the 16th-17th Century, the Portuguese also began sending Goans to **Portugal and Portuguese colonies IN Africa, Burma and other parts of Asia, including India**. These Goans helped the Portuguese government and military to reinforce ties with their colonies. (While many settled in these places, others later moved to other parts of India and abroad. Many in Africa developed strong ties and identified with Africans, and their heirs lost cultural connection with Goa and even actively participated in mid-20th Century African liberation).^[153]

17th-19th Century:

In about the 17th-18th Century, Goa witnessed an economic recession and people migrated seeking better investment and job opportunities.

In the second half of the 18th Century, the British who then occupied most of India began employing Goans for domestic help, which created links between Goa and **Mumbai** (then 'Bombay'). Goans began migrating to Mumbai where their vocational and professional skills landed them jobs quite easily. The semi-literate found jobs as sailors, tailors, cooks, musicians, etc.

By the late 19th Century, coastal and rail transport was established and about one-sixth of the population moved to other parts of India, especially Mumbai. Goans who were semi-literate or literate were familiar with the Roman script, Western music, Sanskrit and Marathi languages, which did not just make it easier to find jobs, but also to integrate with the communities they went to. Depending on how much they earned, either only the earning member or whole families migrated.^[154]

19th Century onwards:

The 19th and 20th Century witnessed large scale migration to **other parts of India**, including **Karachi** (then in India, now in **Pakistan**) but mainly to **Mumbai**, as well as to **Portuguese and British colonies in Africa, Malaysia, Macau and Hong Kong**. After World War II, Goans began to shift base to **England, USA, Gulf countries, Canada and Australia**. Though these included both Hindus and Catholics, it was mainly the Catholics because until the start of the 20th Century Hindu religious restrictions did not allow them to travel overseas.^[155] Muslims migrated too; some served in Portuguese governance.^[156]

When the Portuguese were leaving Goa in 1961 and Goans were considered Portuguese citizens then, Portugal gave Goans the choice to move to Portugal. They even offered to pay their flight tickets to Lisbon and provide temporary, make-shift accommodation for those who needed it.^[157] By the time the Portuguese left, 17% of the Goan population had migrated.^[158]

Even today, the Portuguese law allows those who lived in Goa before 1961 and their descents (up to three generations) to 'recover' their Portuguese nationality. The Indian law however, does not permit dual citizenship. Instead, children of parents of Indian origin or Indians choosing other citizenships are eligible for the 'Overseas Citizenship of India' (OCI)

¹⁴⁹ Rangel-Ribeiro, ed., *Goa Aparanta – Land Beyond the End*, p.202-203

¹⁵⁰ *Ibid.*, p.202

¹⁵¹ *Ibid.*

¹⁵² Khedekar, *Goa: Land, Life and Legacy*, p.145-146

¹⁵³ Rangel-Ribeiro, ed., *Goa Aparanta – Land Beyond the End*, p.202

¹⁵⁴ *Ibid.*, p.202-203

¹⁵⁵ *Ibid.*, p.204

¹⁵⁶ *Ibid.*, p.207

¹⁵⁷ *Ibid.*, p.206

¹⁵⁸ Gama, *Migration from Goa: Factors, Household, Characteristics and Consumption Expenditure Inequalities*, p.13

status. As the European law permits Europeans to live and work in any European country, Goans are now availing themselves of their Portuguese citizenship and OCI status, but are opting for the United Kingdom (UK) instead. Goans today speak English, which makes it easier for them live and work in the UK. Besides, the UK job market is fairly good, and the value of the British Pound (GBP) is higher than the other European currencies (in 2018). These reasons make the UK the choicest place for Goans to migrate, and a big part of the Goan population is currently migrating and living in the UK. Yet again, Goa is witnessing a migration wave.

In addition, the 19th-20th Century has seen an increase in employment in many Indian cities and many Goans choose to settle in other parts of India instead of abroad. Education in Goa too has improved, and it is rare that Goans to move elsewhere to study. However, there are quite a few students who opt to go other Indian cities, or countries like the UK, US, Australia and Canada for higher studies. Many of them stay back in these cities and countries and make them their home.^[159] Goan migration continues; it is an ongoing process.

According to the Goa Migration Survey 2008, 12% of Goan households had at least one family member living abroad, another 4% were those who had returned after working abroad. In Salcete ‘taluka’, 50% household had emigrant(s), followed by Bardez and Tiswadi which had 15% each. 74% of emigrants were Christians. The survey also says that the Goan diaspora can be found in 50 countries: 56% live in the Gulf, 13% in Europe, 11% in South and South East Asia, 10% in North America, 7% are seafarers.^[160]

There are stories of Goans abroad who have succeeded and those who have failed.^[161] Today, Goans are employed as unskilled and skilled labour across various professional sectors. Among them, there are also prominent musicians, doctors, advocates, engineers, politicians, priests, journalists, and writers, especially in Mumbai, Portugal and its colonies, and the UK.

Goans are present in most leading cities across the world, and they have established clubs and associations wherever they are. A few examples include the Goan village clubs (referred to as ‘kudd’ in Konkani), which provides lodging facilities for Goans visiting Mumbai; Karachi Goan Association, a social and sport club in Pakistan; Goan Overseas Association — G.O.A, oriented towards community-service in Canada; and the Goan Association in Paris, France. There are also various social and sports events held during the year such as the Uganda Reunion by Goans who moved to the UK from Uganda,^[162] Goan Soccer League where Goan-Canadians hailing from the different Goan villages form teams to compete in Canada, and the more recently curated ‘World Goa Day’ celebrated by Goans across the across the globe.



Image 18: Inside a Goan club (‘kudd’), Mumbai.

[Source: Sen, “The kudd life: Mumbai’s mini Majordas, Calangutes,” www.hindustantimes.com, March 24, 2016]



Image 19: Karachi Goan Association, Pakistan.

[Source: Karachi Goan Association, “Flashback: From Goa with love,” www.dawn.com, September 16, 2012 (accessed on November 11, 2019)]



Image 20: Goan Soccer League logo, Canada. [Source: “Our Logo Explained,” www.goansoccer.com]



Image 21: World Goa Day, USA. [Source: Facebook, World Goa Day, August 12, 2014 (accessed on November 11, 2019)]

¹⁵⁹ <https://nri.goa.gov.in/articals.html>

¹⁶⁰ Ibid.

¹⁶¹ Rangel-Ribeiro, ed., *Goa Aparanta – Land Beyond the End*, p.206

¹⁶² Ibid., p.212



Image 22: World Goa Day, Australia. [Source: Facebook, World Goa Day, July 25 2015]



Image 23: World Goa Day, Qatar.

[Source: "Goa essence displayed at World Goa Day," www.thepeninsulaqatar.com, November 23, 2017 (accessed on November 11, 2019)]

The return:

As most European colonies began gaining their independence during the 19th-20th Century, and the international and economic situation changed, most people of Goan origin, especially those in Africa either moved to the colonisers' country or came back to Goa.^[163] The Gulf war of the 90's also brought many Goans back to their motherland.^[164] Today, there are very few Goans in Africa; many continue to choose to work in the Gulf. Generally, those living in the Gulf return to Goa after retirement, whereas a decent number of those who moved to western countries tend to settle there. Before, in many cases it was only the earning member that migrated and returned after retirement. More recent trends show whole families migrating. As Goan migration is currently on a rise and so is immigration from other parts of India, Goa and Goans are facing an identity crises in their own land. Various non-governmental groups are being formed in Goa and abroad to address this issue.

As Goans moved to different countries, many maintained ties with Goa, and many completely integrated with their new cultures over time. Those who migrated to neighbouring states, tend to still visit their family deity temple in Goa at least once a year. Goans also visit Goa regularly to spend time with their family, vacation in their ancestral houses, keep abreast with paperwork, etc. Seafarers spend some months of the year at sea and some in Goa. There are also some who migrated decades ago, and rarely or never had a chance to revisit Goa. Some, especially those who migrated when they were kids, or children of parents with Goan origin, come searching for their roots decades later.

All these Goans have brought — and continue to bring — a better lifestyle and the changes are reflected in the food habits, dwellings, clothing, of Goans in the cities as well as the villages of Goa.

Staying rooted and the significance of the Goan home:

It is often said, '**You can take a Goan out of Goa but you cannot take the Goa out of a Goan**'. One of the factors that proves this point is that Goans in Goa as well as those abroad tend to have a strong need to own a house in Goa — whether they see a future in Goa or not! A house is held dear to their hearts. It associated with security, permanence, status and pride. It assures some basic psychological and physical needs such as a sense of belonging to the motherland, and a shelter to fall back on in case of unforeseen circumstances. These emotions are reflected in some Konkani proverbs. For example, '*Aplem ghor baro kosthan dista,*' (in Konkani) which translates to 'Our own home always looks dear to us'.

Goans also have a tendency to go overboard in their enthusiasm while investing in the construction of a house. A proverb says, '*Giristantlo vaddo, nahisook melna fado*'. It means, 'What use is a mansion when there are not enough rags to cover oneself?' This expression is used to express frustration towards ones' forefathers for investing all the family's resources in one big mansion. However, this phrase also explains the psychology of Goan ancestors, who followed a joint-family system and thought that the family would grow and continue to live under one roof perpetually. According to them, building a big house that will last for generations was an act of fulfilling their responsibility. They thought that by doing so their descendants will not have to worry about a house, and will only have to concern themselves with making a living.

Until today, for Goans in Goa and abroad, having a house is more of an emotional rather than a monetary investment. This explains why even in times of financial emergencies, one will rarely see a Goan sell his or her house.^[165] It is often observed that **wherever in the world a Goan may live, he or she tends to hold a deep desire to (1) return to the motherland (2) construct a house in Goa (3) and finally, die in Goa.**^[166]

¹⁶³ Rangel-Ribeiro, ed., *Goa Aparanta – Land Beyond the End*, p.204

¹⁶⁴ Gama, *Migration from Goa: Factors, Household, Characteristics and Consumption Expenditure Inequalities*, p.229

¹⁶⁵ Pandit, *Hidden Hands: Master Builders of Goa*, p.97

¹⁶⁶ Khedekar, *Goa: Land, Life and Legacy*

3.5. BELIEFS AND PRACTICES

As in the rest of India, there is a tendency in Goa to associate various natural phenomena, sites and elements, as well as certain objects, important events, etc. with worship and religion. As many of these entities were from nature, such as rocks, trees, etc. early Goans were delicate in their approach towards the natural environment. Many of these beliefs have evolved from ancient traditions, and though the logic behind most of these have been forgotten today, recent research is proving that many of these practices are rooted in science.

Goan tribals worshipped the earth. Every morning, as soon as they woke up, they would say a little prayer to the **earth** asking for forgiveness for stepping on her. In some communities, the earth in the form of an anthill (*'santer'* in Konkani) is worshipped.^[167]

Earth was an integral part of the lives of early Goans. They used to apply mud to their bodies when taking a bath (mud therapy suggested by 'Ayurvedic' science), and would walk barefoot on earthen floors.^[168] Earthen houses, fences, seating, etc. comprised villages that were entirely built with mud. Earth was also used to mould cooking stoves, utensils, sacred idols, musical instruments, children's toys, etc. As the society progressed, earthen houses and items continued to be used by people of all socio-economic strata.^[169]

THE HINDUS

The Hindu Vedic texts make reference to architecture. The 'Maanava Shilpa' in the '**Vastu Shastras**' part in these texts discuss architectural guidelines for domestic dwellings, public buildings, village and town planning, etc.^[170]

Site selection: In case of a house whose owners were Hindu, a Hindu priest called the 'Bhat' is called.^[171] He along with a builder would decide on the site, orientation, access to the house, auspicious dates to start construction, celebrate the inauguration, etc.^[172]

The site is selected based on science and the horoscope, which takes into consideration the earth's magnetic forces and five elements i.e. space, air, fire, water and earth. The combination of these is believed to ensure that the house WILL take maximum benefit from nature's forces — land, atmosphere, water, sun, celestial forces; thus ensuring health, wealth and prosperity of those who live in it. Below are few aspects taken into consideration when selecting a site for construction.^[173]

- **Site and its vicinity:** Care was taken to avoid cremation or burial grounds, or pastures and grazing land. It was ensured that no trees with long roots occupied the land as they would come in the way of construction of the house. A fertile land with a water source nearby was also essential.
- **Soil:** Such a site would be selected where the soil was not black, clayey (to prevent landslides), marshy, saline or had a bad odour. The soil was also tested for its load-bearing capacity.
- **Orientation:** The main openings of the house, are directed towards the south-west to allow maximum natural light. According to the 'Vastu' principles, the plot should be either square or rectangular in shape. The sides of the rectangle should measure 1:2 in their proportions, with the north and south sides being shorter. If all the corners do not angle at 90°, the plot should be demarcated in such a way that the distance between the south-west and north-east corners are longer than the south-east and north-west corners.

Before the construction or completion of the house, a ritual called the '**Grihashanti puja**' is held. This is meant to ward off any evil-eye or negative forces that might come in the way of the construction and upkeep of the house. It is prayer to welcome positive energy into the house and in the lives of its inhabitants. As per the ritual proceedings, a coconut is tied to the roof truss and then the truss is mounted. The owner would then go and present a cash gift to the masons and carpenters (both are referred to as '*mestre*',^[174] '*maestre*',^[175] '*mistri*',^[176] '*meste*',^[177] in Konkani), who would be standing outside the house. (Before this, the owner paid the master craftsmen in kind only. Exchange of cash started with this ritual.) However, the monetary value of the gift was of little importance to the craftsmen. It was rather a

¹⁶⁷ Khedekar, *Goa: Land, Life and Legacy*, p.115

¹⁶⁸ *Ibid.*, p.33,121

¹⁶⁹ Lobo, *Earth in Architecture*, p.36

¹⁷⁰ Silveira, *Lived Heritage, Shared Space: The Courtyard House of Goa*, p.22

¹⁷¹ Pandit, *Hidden Hands: Master Builders of Goa*, p.105

¹⁷² Silveira, *Lived Heritage, Shared Space: The Courtyard House of Goa*, p.23

¹⁷³ *Ibid.*, p.23-24

¹⁷⁴ Pandit, *Hidden Hands: Master Builders of Goa*, p.88,94

¹⁷⁵ *Ibid.*, p.89

¹⁷⁶ *Ibid.*, p.94

¹⁷⁷ *Ibid.*, p.111

moment of pride for them as their names would be associated with the house and the owner's family would honour them.^[178]

On completion of the house, an inauguration ceremony called 'Grihapravesha' is celebrated.^[179]

THE CATHOLICS

Saint Thomas ('*São Thomé*') is believed to be the **patron saint of Goan masons and carpenters**. Thomas, the apostle of Jesus landed in the Indian state of Kerela and is well known in the country for spreading the Christian faith. It is believed that on his arrival, he was sold as a carpenter. Legend has it that a king asked Thomas to draw plans for his palace and was then entrusted with the task of building the palace. While the king was away, Thomas distributed the king's wealth, including wood, stones, etc. to the poor and the palace was never built. On the king's return, Thomas told the king that there is a bigger palace waiting for him in heaven. The king was so enraged. He chained Thomas and he himself finally fell ill and died. It is believed that the king saw his palace in heaven and came back to earth to reward Thomas with material wealth as well as the power to change people's lives. The higher class envied Thomas for his gifts and finally martyred him.

In Christian iconography, Saint Thomas is depicted as a man with white hair and beard, dressed in robes and a cloak. In his left hand is an object that looks like a lance. The early converts thought of it as a pickaxe and thus he became the patron saint of masons and carpenters. However, it is only in India that Saint Thomas holds this title (In Portugal, St Joseph is accepted as the patron saint of builders, though this might be a recent title). In Panaji, the capital city of Goa, there is a chapel dedicated to St Thomas. It was first built by the masons of Goa in 1845 in front of Rua de Avril and them broken down and rebuilt in 1849 at Tobacco Square. The masons also managed the chapel administration.^[180] Saint Thomas chapel can today be seen at Rua São Tomé near the post office in Patto, Panaji.



Image 24: St. Thomas Chapel, Panaji, North Goa.

[Source: Facebook, Goa – Then & Now, April 1, 2016) (accessed November 11, 2019]

Another study (Pandit et al., *Hidden Hands: Master Builders of Goa*, 2003) recounts that before carpenter Zuzé Sequeira would start the roof work, he would carve a small Christian cross on a wooden beam or rafter, and worship it with candles and flowers. He would then engrave the commencement date on one of the beams. It must be noted that he was the only carpenter from among the ones interviewed for that study that reported to practised this ritual.^[181] This ritual could correspond to the Hindu 'Grihashanti puja'.



Image 25 and Image 26: Date of construction engraved on the truss of a house. Colva, Salcete, South Goa, 2014.

¹⁷⁸ Pandit, *Hidden Hands: Master Builders of Goa*, p.132

¹⁷⁹ Silveira, *Lived Heritage, Shared Space: The Courtyard House of Goa*, p.23

¹⁸⁰ Pandit, *Hidden Hands: Master Builders of Goa*, p.110-111

¹⁸¹ *Ibid.*, p.130

HINDUS AND CATHOLICS

While there are some sets of beliefs that may be exclusive to the Hindu or Catholic faith, there are others which could be considered as shared between the two communities. It could be because most Goan Christians are Hindu converts and have adapted their Hindu beliefs to suit Christianity, or because their Christian faith coincided in certain aspects to their previous Hindu faith, or simply because of practical reasons such as topography and geographical conditions. Some of these beliefs and rituals are listed below.

Foundation of the house: (*'bunyard'* in Konkani) Hindu and Christian rituals with regards to laying the foundation of a house was related by Mason Bapu Shabi Gadakar from Oxelbag in Dhargalim VP of Pernem district, who is in his late 60s. In a Hindu house, the first stone laid to built the house is engraved with a 'swastika' and as a ritual, the 'bhat' recites prayers. 'Panchadhatu' i.e. five metals such as copper (*'thambé'* in Konkani), brass, zinc (*'pintal'*), steel, silver (*'channi'*), gold (*'bhangar'*) wire, etc. are offered to God along with some moss (locally referred to as *'showko'*) collected from the neighbouring pond. The ceremony takes about 1-2 hours.

Among the Catholics, a cross is engraved on the foundation stone, and a priest says prayers. A small cross made from gold is buried in the construction site during the ritual.

Orientation of the alter or 'devaghor': (The latter is a Konkani word and literally translates to 'House of God'.) Most, if not all Indian houses, irrespective of religion, have a dedicated place for worship i.e. an altar or a room. In case of a Goan Hindu house, a 'bhat' would decide the position of the altar or 'devaghor' or temple. He would choose a side facing the east or south-east.

As for the Catholics, a priest would lead. He would direct that the altAr or 'devaghor' or chapel be built facing the village church, neighbourhood chapel or cross station.

From then on, the master-masons would take over and irrespective of religion, the decided side was referred to as 'the right side' (referred to as *'uzvi kode'* in Konkani).^[182]

Religious symbols: The courtyard of a Hindu house is ordained with a 'tulsi vrindavan' i.e. a post built stone-masonry or mud, in which the sacred 'tulsi' plant is planted.^[183] In Catholic houses, a 'cross' is often seen instead. It is not uncommon to see posts for crosses that bear resembles the 'tulsi vrindavan'.



Image 27: 'Tulsi vrindavan' built with earth. Image 28: 'Cross'.

Use of cow-dung: (cow dung is called *'shen'* in Konkani) There are traditional houses of both Hindus and Christians where floors are covered with cow-dung. In some regions in Goa, walls are also covered with the same. The cow is considered sacred in the Hindu religion. The practice of using cow-dung in houses construction could have a religious significance, or could be because of the ease of availability, either or both of which could have contributed to the building culture of Goa.

Whether some or all of these rituals are practised in modern Goan society, depends on whether a certain community and family chooses to follow them.

¹⁸² Pandit, *Hidden Hands: Master Builders of Goa*, p.105

¹⁸³ Rangel-Ribeiro, ed., *Goa Aparanta – Land Beyond the End*, p.94

TRADITIONAL LIFESTYLES AND SYSTEMS THAT SUBLIMINALLY AIDED CONSERVATION OF EARTH STRUCTURES

[Extract from my master's dissertation, '*Regional Distinctiveness of Earthen Structures: Construction Techniques and Conservation Approaches. A Comparison of Mudwall/Cob Buildings in Perthshire – Scotland and Normandy – France*', 2015).]

Traditional practices and beliefs seemed to have had a significant bearing on the care and sustainability of early buildings. In fact, their contribution to conservation might have weighed more than most tangible aspects of traditional culture.

However, as most traditions and beliefs laid embedded and hidden in the routines of everyday life, and – if observed and perceived minutely – often included daily activities and rituals that bore no intention of conservation, they remained unnoticed, unrecognised and unnecessary of mention. This lack of transparency led to the lack of acknowledgement and worth attached to the role traditional lifestyles are likely to have played in conservation... and continues to be the case...

Even more so, now that traditional lifestyles have disintegrated to give way to modern living, it is even more difficult to trace and fragment aspects of traditional life that integrated a culture of conservation and self-sustenance. This study however, was able to unearth some legends, folk stories, and practices from different parts of the world – that conscious, subconscious, or unconscious to the mind of traditional inhabitants – largely contributed to the upkeep, longevity and allied sustainability of traditional buildings.

Burning fuel and incense in houses keeps dampness and insects away – India: In India, which is home to numerous clay building traditions, various rituals involve the burning of fuel and incense on a daily or occasional basis and the smoke and essence it gives out keeps dampness and insect infestation on walls at bay.

Such rituals include:

In some regional Indian cultures, the daily activity of cooking is performed on traditional stoves inside the house.

- Incense sticks are often left burning for religious reasons or for fragrance.
- In the Indian state of Goa, frankincense is flamed and fumigated during religious occasions, wedding rituals, after bathing infants, etc. The reasons may vary from beliefs like warding off evil, inviting good omen, or just keeping mosquitoes and other insects away and sanitising the space.

The guardian force 'Rakondar' that kept drains and thus dampness in check – Goa, India: In Goa, there is an old 'belief' in the existence of a good spirit, locally referred to as 'Rakondar' (guardian). This respected and sacred force was believed to walk along drains, and so the local people would ensure regular repair and maintenance of their drainage system, which in turn prevented waterlogging in the area and protected buildings from damp. The *Rakondar* was/is believed to guide and protect one while journeying into the deserted dark of the night especially during the time before electricity was introduced; however, one was not supposed to turn back and look, as the existence of this force was only meant to be sensed or felt. Stories of the *Rakondar* continue to be widely popular among the older generation, though the belief surrounding its connection with the drains is vocal only amongst a very few.

Planting trees that would provide for the upkeep of homes – Goa, India: An example of sustainable conservation is the growing of local tree varieties at the time of building one's house, with a vision that they grow along with the owners and provide for upkeep of the house and the owners themselves when they are old and maybe fragile to fend for necessities. Teak, bamboo, mango and jackfruit trees were particularly popular in Goa. Teak provided wood for the repair and replacement of traditional pan-tile roofs, which after a few years of installation, might benefit from some attention. Bamboo provided the supply of raw materials required for weaving mats and baskets used in farming, which in turn supported some earth building techniques such as Cob. Mango and Jackfruit were popular for their wood as well as fruits.

3.6. EARTH CONSTRUCTION TECHNIQUES IN GOA

Earth is integral to Goa's architecture. Much of Goa's indigenous architecture comprises earthen dwellings. Even today, Goa's architectural landscape is dotted with earthen structures that vary in size from a single room to mansion houses. Mud houses shelter all sections and classes of the Goan society. However, many of these houses are plastered, which makes it hard to spot them.

The soil for building was usually sourced for around the house, and the type of soil determined the construction technique employed. There are various earth-construction techniques identified in Goa. Those that concern Goa's vernacular architecture include the following.

MUD-AND-WOOD OR WATTLE-AND-DAUB

Various records mention early Goan houses being built in wattle-and-daub.^{[184][185][186][187]} These houses made of earth and wood have most probably perished, and are hardly seen today. However, recently a priest related that he remembers seeing such houses between Bicholim and Assonora in North Goa, near Chowgule mining company in about 1973-1974. K. D. Sadhale, Author of the chapter 'Pre-Portuguese Architecture' in the book, 'Goa Aparanta – Land Beyond the End' (2008) also mentions, 'Even a few decades ago, I saw such dwellings in remote parts of Goa; the walls were partitions of bamboo strips or of twigs, mud plastered inside and out to give a smoother surface'.^[188]



Image 29: Mud-and-wood or Wattle-and-daub constructions in Goa.

[Source: <https://www.archgoa.org/material%20and%20const/mac.htm> (accessed on November 11, 2019)]

There are also mentions of houses having an upper floor. For these, coconut rafters were fitted horizontally. Matured bamboos, 'Bhillamad' or 'Karanv' (a jungle plant) sticks were placed on the rafters. The floors were covered with mud and coated with cow-dung.^[189]

COB^[190] (referred to as 'mathe ghor' in Konkani, which literally translates to 'house built with earth')

This is the most well-known earth-building technique in Goa. Cob houses exist in almost all parts of Goa, even today. Cob requires earth that has a homogeneous and plastic consistency. Earth is either sourced from low lying lands in areas close to the seashore or from the hill sides; sometimes these two types of soil are mixed. Large stones are removed, and the earth is stocked in heaps. The heaps are mixed with water using a spade and are kneaded with feet. A cavity is made in the middle and water is filled in it before the earth is left to rot for about 4-15 days. During this period, water is added in the cavity and is also sprayed on the heap of mud in order to maintain the moisture that is lost due to evaporation. Just before building, the earth is mixed and kneaded again. However, no water is added at this point. The walls are built in horizontal 'lifts' (In English, a layer of earth in earthen constructions is referred to as a 'lift'; in this context, if layers exist within a 'lift' they are often simply called 'layers'. In Konkani, a 'lift' is called as 'parro'). The master-mason takes his position on the 'lift'. The prepared earth is made into lumps by other masons and passed to the master-mason by flinging the lumps to him. The master-mason then piles these lumps one over the other by throwing them onto the wall; the throwing gesture permits better adhesion. The soil that bulges out on the sides is pulled out in an elongated gestures and refitted into the wall, thus allowing alignment of 'lifts'. The 'lift' is also compacted on either sides by using hands, and is made smooth by rubbing the sides in cyclic or upward motions. The

¹⁸⁴ Pandit, *Hidden Hands: Master Builders of Goa*, p.87

¹⁸⁵ Munj, *Colour in Architecture – Perception of Colour in Spatial Environment in Context of Goa*, p.36

¹⁸⁶ Lobo, *Earth in Architecture*, p.20

¹⁸⁷ Silveira, *Lived Heritage, Shared Space: The Courtyard House of Goa*, p.74

¹⁸⁸ Rangel-Ribeiro, ed., *Goa Aparanta – Land Beyond the End*, p.91,94

¹⁸⁹ Khedekar, *Goa: Land, Life and Legacy*, p.241-242

¹⁹⁰ Lobo, *Earth in Architecture*, p.47-50

ends are slanted, which facilitates the joining of the first and last section of the 'lift'. Each 'lift' is left to dry for about a week. After about three days of completing the 'lift', it is compacted with a wooden batten ('patnem' in Konkani) to lend a neat finish. The 'lift' is left to dry for another three days. Once it is completely dry, construction of the next 'lift' begins. The 'lift' below is sprinkled with water before the constructing the next 'lift'. This is done so that the upper 'lift' sticks better. Sometimes, during the construction process, laterite-stones are used along base-courses, corners, and door and window frames.

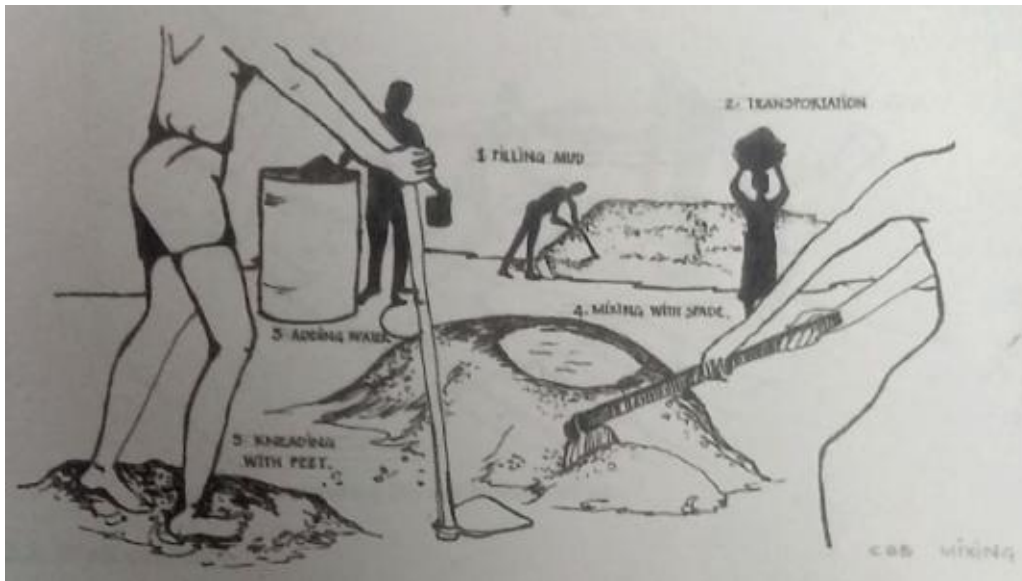

Image 30: Preparation of the cob mix.

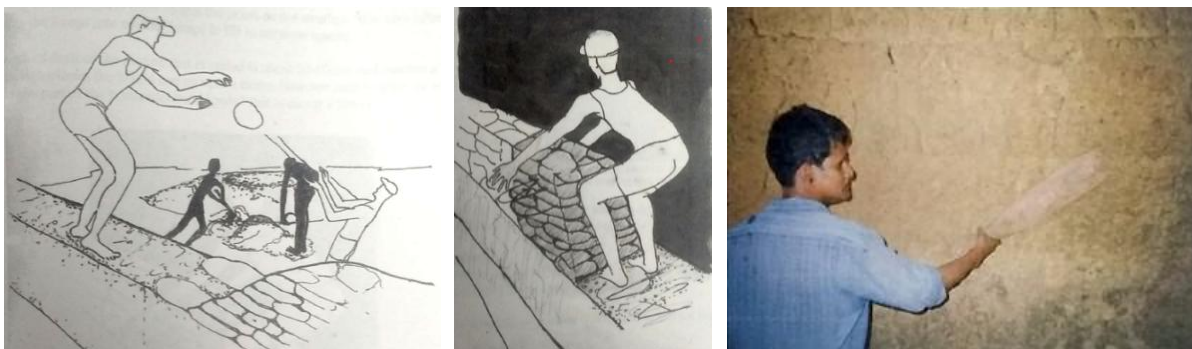

Image 31, Image 32 and Image 33: Cob construction process in Goa.

[Source: Lobo, *Earth in Architecture*, p.47-49]

ADOBE-BRICKS ('box' or 'caix' in Konkani)

For adobe-bricks, the type of soil selected and the soil preparation method is similar to that employed in cob constructions. They adobe-bricks are moulded in wooden frames and dried for about 8-10 days. During this period, the bricks are turned every couple of days so that each side is exposed to the sun, allowing for uniform and complete drying of the brick.

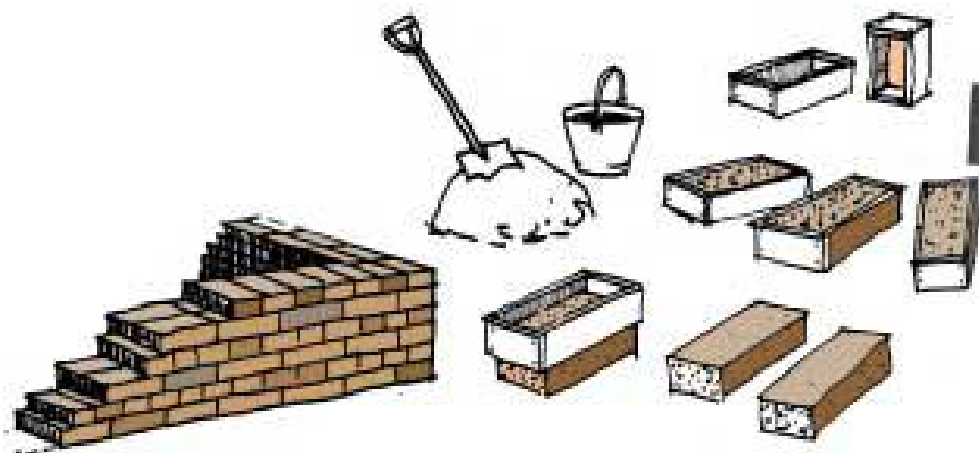

Image 34: Adobe construction process in Goa.

[Source: <https://www.archgoa.org/material%20and%20const/mac.htm>] (accessed on November 11, 2019).

COMPOSITE MUD WALLS^[191]

Composite mud walls comprise earth and rounded laterite rubble. The rubble forms the centre and is covered with earth. These are found in regions of Goa where more laterite than earth is found, such as Cumbarjua, Siridao, Old Goa, Corlim and Agassaim. Usually red coloured soil is used for these constructions. The soil preparation process is similar to that of cob constructions. However, it is left for rotting for about 3-4 days, and construction of 'lifts' usually begin in the corner. A thread is tied from one corner of the wall to the other to provide a reference for alignment of walls. The rubble along with mud is laid at the centre of the wall, leaving a setback of 10-15cm on the sides. It is then covered with mud on all sides. The starting corner of the 'lift' is kept unfinished and slanting as it permits better joinery with the final section of the 'lifts'. Like cob, the 'lift' is left to dry for about a week. It is compacted with a wooden batten after three days of completion to shape and straighten the 'lift'.

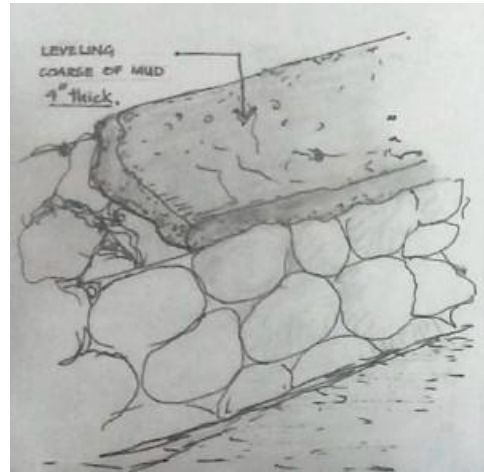

Image 35 and Image 36: Composition of a composite wall.

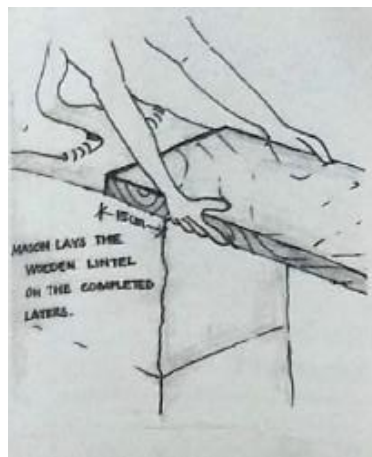
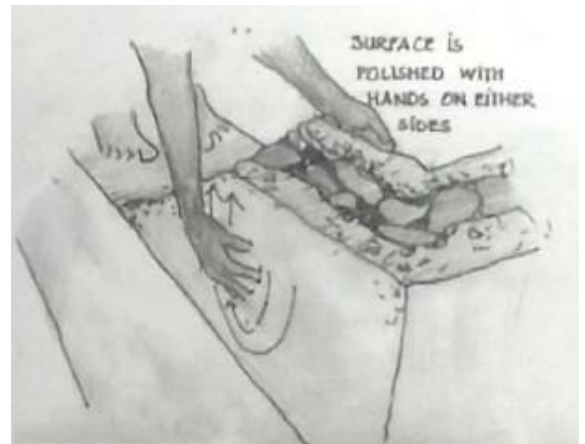
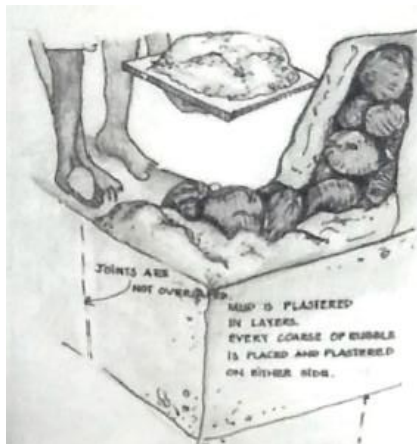

Image 37, Image 38, Image 39, Image 40, Image 41 and Image 42: Construction process, composite walls in Goa.

[Source: Lobo, *Earth in Architecture*, p.51-53]

¹⁹¹ Lobo, *Earth in Architecture*, p.51-53

RAMMED-EARTH ('*taip*' in Konkani)

Rammed-earth constructions are relatively new in Goa as compared to other earthen construction techniques. Most rammed-earth houses in Goa are less than 100 years old. These houses are usually built with red coloured earth found on hillocks. Presence of significant quantities of gravel is a must. The gravel may be found naturally in the soil or may be added. The final consistency of the treated soil needs to be homogeneous and plastic, but less moist than cob constructions. Like cob constructions, the earth is mixed with a spade and kneaded with feet, the pile of mud is left with a cavity filled with water for about 15 days, and is mixed again before commencing the building process. The rammed-earth form-work in Goa is made with shutters made with wood from a Mango tree (in Konkani, each horizontal member that comprises the shutter is called '*fadim*' and the shutters are called '*taip*'). The vertical members of the shutters are made of the coconut tree trunk (these are called '*aché*' or '*vanshé*' in Konkani). The form-work is installed, and 'lifts' are built one at a time, usually starting in a corner. After about 10 hours or a day, the wall is compacted with a wooden batten to give it a clean finish.^[192] In case of a gable, the central pillar is built first. A rope is then tied from the roof-line to the centre of the pillar, which marks the upturned 'V' shape of the gable, and provides a reference while ramming.

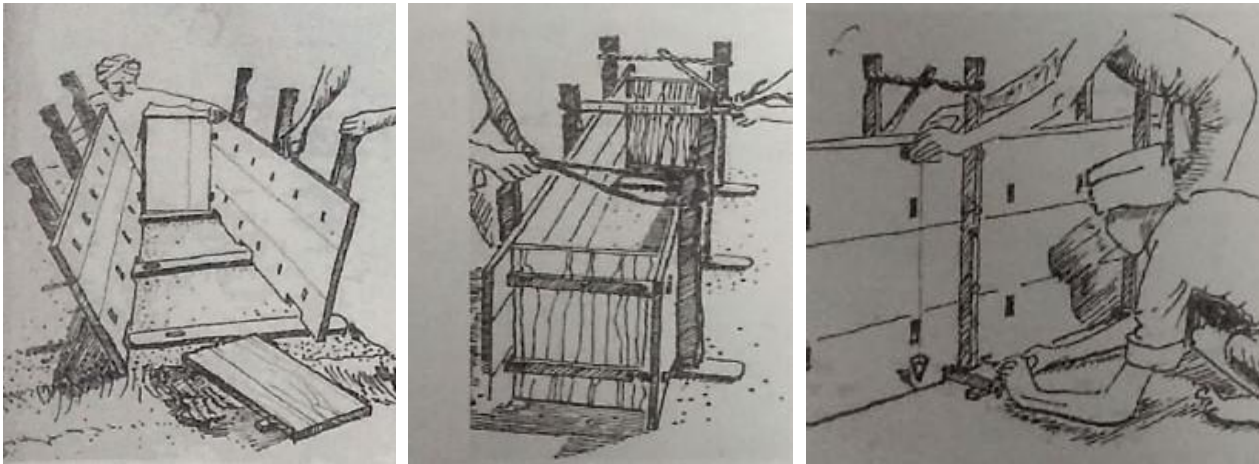

Image 43, Image 44 and Image 45: Mounting of the rammed-earth form-work.

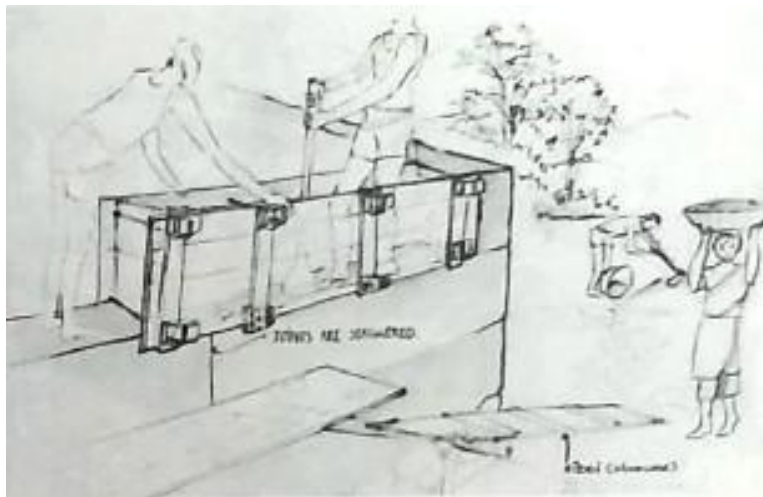

Image 46: Rammed-earth construction process.

[Source: Lobo, *Earth in Architecture*, p.43-46]

Earth is also used as mortars, especially in laterite masonry constructions, and as plasters as well. It is also used to build compound walls, and fences and water-retaining walls in agricultural fields.^[193] In addition, earth is used in flooring, building 'sopos' (in-built masonry seats in the veranda or porch), and wood-burning stoves, as well as for eaves detailing, finials for gate-posts, etc. Baked earth is used in the form of bricks, roof-tiles, etc.

¹⁹² Lobo, *Earth in Architecture*, p.41-46

¹⁹³ Khedekar, *Goa: Land, Life and Legacy*, p.34

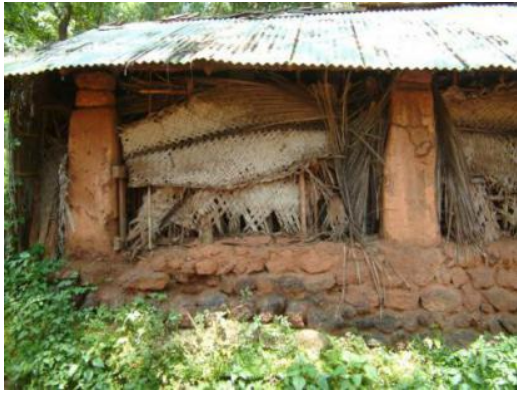

Outhouses, roof supported on earthen pillars.

Image 47: Arvalem, Bicholim, North Goa. [Photo credit: Jose Lourenco] Image 48: North Goa, 2015.



Image 49: Earthen mortars in laterite masonry. [Photo credit: Jose Lourenco]

Image 50: Earthen plasters. Bardez, North Goa, 2015.



Image 51: Compound wall. Comba, Margao, South Goa. [Photo credit: Jose Lourenco]

Image 52: Fences in agricultural fields. Ponda, South Goa. [Photo credit: Jose Lourenco]



Image 53: Water retaining walls in agricultural fields. Aldona, Bardez, North Goa, 2015.

Image 54: Water retaining walls in salt pans. [Source: www.missiongreengoa.blogspot.com]

3.7. EVOLUTION FROM THE PRE-PORTUGUESE TO THE INDO-PORTUGUESE HOUSE

Early Goans were hunter-gatherers and the earliest houses in Goa were caves.^{[194][195]}

Goan tribal communities lived in close relation with nature with no stark separations between man and his surrounding natural environment.^{[196][197]} Individual houses and **settlements** comprising clusters of houses were nestled between trees and plants, creating a network of orderly, self-sufficient villages.^{[198][199]} As various empires reigned over Goa over the centuries, some towns sprung up. These had magnificent edifices and towers, streets and squares amidst gardens, orchards and pools.^[200] Though much of these were destroyed by the Portuguese to create an impressive heritage of their own, there is no doubt that inherent culture of the Goan people has been imbibed in tangible and intangible forms in the Goan communities that exist today.^[201]

Houses were built using natural materials such as wood, leaves, grass, bamboo, coconut and betel-nut palms. Later, houses came to be built with mud walls, cow-dung, lime, wood and fired-clay roof-tiles.^{[202][203][204]} They were constructed by the inhabitants with their plain hands. Houses did not have symmetrical layouts, and walls had no straight lines or right angles.^{[205][206]} Outdoor and indoor spaces were less defined. There were no compound walls or walls within the house.

Sometimes, a rim less than a foot high was built with mud and cow dung to demarcate an **external courtyard** of the house, which was used to dry clothes, agricultural produce, as well as for playing games, socialising, etc. The central feature of the courtyard was however, the 'tulasi vrindavan' i.e. a Hindu religious symbol.^[207] The 1736 religious Inquisition prohibited the 'tulasi' in individual courtyards. Hindus began going to public 'tulasi vrindavans' established in public places.^[208] Newly converted Catholics replaced the 'tulasi' in their front-yards with a cross, a Christian religious symbol. As the Portuguese re-establish religious freedom in the 19th Century, the 'tulasi' once again made its appearance in the front courtyard. Christians continued to retain the cross.^[209]

Many houses built during the pre-Portuguese and Portuguese era have an **inner courtyard** called 'raj angonn',^[210] 'rajangan'^[211] or 'razagaon'.^[212] It is an open quadrangle within the limits of the house. The quadrangle is surrounded by a veranda, which is a step or two higher and gives access to the house. The veranda is decorated with intricate columns and brackets, pilasters, and corbelling made with country tiles. It is hard to say whether the corbelling dates to pre-Portuguese or Portuguese times.^[213]



Image 55, Image 56 and Image 57: Corbelling made with 'Country-tiles'.

[Source: <https://www.archgoa.org/climate%20and%20architecture/climate%20and%20architecture.htm> (accessed on November 11, 2019)]

¹⁹⁴ Pandit and Mascarenhas, *Houses of Goa*, p.14,87

¹⁹⁵ Fernandes, *The Rational of Primitive Shelter Case: Goa*, p.14,74-76

¹⁹⁶ Khedekar, *Goa: Land, Life and Legacy*, p.33

¹⁹⁷ Rangel-Ribeiro, ed., *Goa Aparanta – Land Beyond the End*, p.94,195

¹⁹⁸ Ibid.

¹⁹⁹ Pandit and Mascarenhas, *Houses of Goa*, p.94, 114

²⁰⁰ Rangel-Ribeiro, ed., *Goa Aparanta – Land Beyond the End*, p.91

²⁰¹ Ibid.

²⁰² Pandit and Mascarenhas, *Houses of Goa*, p.14

²⁰³ Fernandes, *The Rational of Primitive Shelter Case: Goa*, p.14,74-76

²⁰⁴ Rangel-Ribeiro, ed., *Goa Aparanta – Land Beyond the End*, p.91,94,195

²⁰⁵ Pandit and Mascarenhas, *Houses of Goa*, p.94-95

²⁰⁶ Rangel-Ribeiro, ed., *Goa Aparanta – Land Beyond the End*, p.94

²⁰⁷ Ibid.

²⁰⁸ Pandit, *Hidden Hands: Master Builders of Goa*, p.103

²⁰⁹ Rangel-Ribeiro, ed., *Goa Aparanta – Land Beyond the End*, p.104

²¹⁰ Pandit and Mascarenhas, *Houses of Goa*, p.34

²¹¹ Rangel-Ribeiro, ed., *Goa Aparanta – Land Beyond the End*, p.95

²¹² Issar, *Goa Dourada: The Indo-Portuguese Bouquet*, p.159

²¹³ Rangel-Ribeiro, ed., *Goa Aparanta – Land Beyond the End*, p.95

While the inner courtyard is featured in many Hindu as well as Christian houses, these two communities use this space for different functions. The Hindus used it for worship (it is possible that during the Inquisition when the ‘tulsi’ was prohibited in the front yard, some families shifted it to the inner courtyards, away from the public eye), drying agricultural produce and children used it to play. These were in fact the original uses of courtyards in traditional tribal communities. The Christian inner courtyards are usually garden spaces, meant to welcome cool breeze and in which to spend lazy evenings.^{[214][215]} It takes on an European function when winters or monsoons keep people indoors from which they can benefit from the visual beauty the garden provides.^[216] The inner courtyard of the pre-Portuguese house bears A resemblance to the patio of the traditional houses of Mediterranean.^[217]

In Goa, what is called the ‘**balkâmv**’ (in Konkani) and ‘**balcão**’ (in Portuguese) is actually a porch i.e. a structure projecting in front of the entrance of a building, its cover supported by columns and pillars.^[218] However, in Portugal ‘**balcão**’ refers to the platform that extends from the facade and is enclosed by balusters or grills. Its roof is supported by columns, brackets and corbels, and is sometimes completed with cornices and eaves.^[219] This feature is actually indigenous and distinct to Goan architecture and was called the ‘**sopo**’, which is an in-built masonry seat in a veranda or porch. It however, became prominent in Goa in the late 18th Century, when under the Portuguese influence it took the form of a ‘**balkâmv**’ or ‘**balcão**’.^{[220][221][222]} The facades of rural Goan houses also had a lean-to thatch roof held by wooden posts. This space was called the ‘**padvi**’ or ‘**pakadi**’, which also eventually evolved into the more stylish veranda with decorative railings and colonnades.^{[223][224]} Verandas evolved into balconies i.e. small galleries with railings projecting from doors on the upper floors.^[225] The ‘**padvi**’ was meant to protect the walls from rain water, and for residents to enjoy the breeze on sunny evenings, chat and gossip. The ‘**balkâmv**’ and the veranda also protect wall facades, and continue to be used for resting, socialising and occasionally, for performances such as the traditional Goan ‘**mando**’ music.



Image 58 and Image 59: The ‘**padvi**’ or ‘**pakadi**’ i.e. the lean-to with masonry seats, along the facades of rural Goan houses eventually evolved into a veranda with decorative railings and colonnades under the Portuguese influence, and took the form of a ‘**balkâmv**’ or ‘**balcão**’.

[Source: <https://missiongreengoa.blogspot.com/2015/03/learning-outdoors-with-dempo-bba-aangan.html?view=timeslide> (accessed on November 11, 2019)]



Image 60: The ‘**balkâmv**’ or ‘**balcão**’ of the Indo-Portuguese house. Margao, Salcete, South Goa, 2012.

²¹⁴ Rangel-Ribeiro, ed., *Goa Aparanta – Land Beyond the End*, p.103
²¹⁵ Silveira, *Lived Heritage, Shared Space: The Courtyard House of Goa*, p.69
²¹⁶ Rangel-Ribeiro, ed., *Goa Aparanta – Land Beyond the End*, p.103-104
²¹⁷ Issar, *Goa Dourada: The Indo-Portuguese Bouquet*, p.159
²¹⁸ Silveira, *Lived Heritage, Shared Space: The Courtyard House of Goa*, p.104
²¹⁹ *Ibid.*, p.105
²²⁰ *Ibid.*
²²¹ Rangel-Ribeiro, ed., *Goa Aparanta – Land Beyond the End*, p.95
²²² Pandit and Mascarenhas, *Houses of Goa*, p.34
²²³ Silveira, *Lived Heritage, Shared Space: The Courtyard House of Goa*, p.106-107
²²⁴ Rangel-Ribeiro, ed., *Goa Aparanta – Land Beyond the End*, p.95
²²⁵ Silveira, *Lived Heritage, Shared Space: The Courtyard House of Goa*, p.109

Back in time, Goan houses comprised a single room, which was used as a kitchen, dining room, dressing room, bedroom, or hall.^{[226][227][228]} However, whenever there was a need for a room, a make-shift screen made with natural materials provided a temporary partition.^[229] It was the Portuguese who brought about the concept of **division of interior spaces** and need for privacy.^{[230][231]}

As interior spaces evolved, in some houses, a step or two up from the courtyard would give access to the veranda, and then the house. Adjoining the veranda was a big, multi-functional room, following which was the kitchen.^[232]

Bigger houses had a bathing area, usually in a kitchen corner. Two half-length walls enclosed the space, and an opening gave access to a large vessel which was placed on a wood fired stove to let the water boil.^[233] This kind of a bathroom is called '*mori*'.

A typical traditional Goan house before it imbibed Portuguese influences, included a central courtyard ('*raj angonn*,' '*rajangan*,'^[234] or '*razagaan*'^[235] in Konkani). One side of the courtyard gave access to the hall ('*osro*' in Konkani), the other side led to the dining room ('*vasri*') at the rear of the house, and to its sides were the living rooms ('*kuddi*'). At the entrance was the '*sopo*' (later called '*balkâmv*' or '*balcãõ*').^[236]

The Portuguese arrived in Goa in 1510 and as they established themselves in the decades that followed, Portuguese nobles ('*fidalgos*' derived from Portuguese) who were posted in Goa on duty, began building massive houses with intricate detailing. These houses, built in 17th-18th Century **Portuguese era**, no longer exist. The Archbishop's Palace in Old Goa however, which was built in 1608 is still standing today, and gives an idea of the extent of the houses built during this period.^[237]



Image 61: Archbishop's Palace. Altinho, Panaji, North Goa.

[Source: <https://timesofindia.indiatimes.com/travel/destinations/Archbishops-Palace/ps52499616.cms> (accessed on November 12, 2019)]

In the last few decades of the 17th Century however, the Portuguese hold on Goa began to weaken, and people living in towns started shifting to the countryside.^[238] Following this, in the mid-18th Century, the Marquis of Pombal, a Portuguese minister and advisor at that time, decided to give citizens equal stature based on merit — and not on colour. This erased the lines that existed between the Goans and the Portuguese in Goa. Many affluent Goans started building massive houses influenced by the Portuguese and other Europeans.^[239] These were mainly built by Christian converts to

²²⁶ Rangel-Ribeiro, ed., *Goa Aparanta – Land Beyond the End*, p.94

²²⁷ Pandit and Mascarenhas, *Houses of Goa*, p.14,94-95

²²⁸ Khedekar, *Goa: Land, Life and Legacy*, p.242

²²⁹ Ibid.

²³⁰ Pandit and Mascarenhas, *Houses of Goa*, p.34

²³¹ Ibid., p.94-95

²³² Ibid., p.14

²³³ Ibid., p.14-15

²³⁴ Rangel-Ribeiro, ed., *Goa Aparanta – Land Beyond the End*, p.95

²³⁵ Issar, *Goa Dourada: The Indo-Portuguese Bouquet*, p.159

²³⁶ Pandit and Mascarenhas, *Houses of Goa*, p.34

²³⁷ Rangel-Ribeiro, ed., *Goa Aparanta – Land Beyond the End*, p.100

²³⁸ Pandit, *Hidden Hands: Master Builders of Goa*, p.97

²³⁹ Rangel-Ribeiro, ed., *Goa Aparanta – Land Beyond the End*, p.101,103

assert their cultural identity, but also by the few Hindus who found favour with the Portuguese ruling class.^[240] The old mansion houses that we see in Goa today belong to this 18th-19th Century period.^{[241][242]}



Image 62: Silva house. Margao, South Goa.

[Source: <https://www.trawell.in/goa/panjim/house-of-seven-gables-sat-burzam-ghor> (accessed on November 12, 2019)]

Though land was constrained in the towns and ample in the villages, massive houses were built in both towns and villages alike.^[243] The scale, number of rooms and character of these houses did not depend on the owner's economic status, or the size of the family.^{[244][245]} Plans and designs for these houses were borrowed from the houses of Portuguese nobles in Goa or were chosen from catalogues that came from Portugal and other parts of Europe.^{[246][247][248]} Master-masons and carpenters also copied designs and motifs from temples, churches and from other craft mediums as well, and exclusivity was an important factor.^{[249][250]}

The exterior of these houses usually had compound walls with decorative gateposts, intricate 'tulsi vrindavans' in Hindu courtyards, balustraded verandahs, wrought-iron balconies, European-Classical columns, pilasters and brackets, and decorative French windows. Some houses also displayed stucco mouldings in contrasting colours and art décor motifs.^{[251][252]} Portuguese *Azulejos* tiles (some with Indo-Portuguese motifs),^[253] and Goan oyster-shell windows (oyster-shells were used before the advent of glass) also decorated some facades.^[254] Some houses were built to have double storeys. The height of the plinth was raised to accommodate shops, granaries, storerooms and servant quarters on the ground floor.^[255]

The interior comprised reception spaces, ceremonial halls ('*sal*' in Konkani), smaller '*saletas*', funeral parlours, estate offices, dining room, niches for chapels and temples, bedrooms, store and kitchen.^{[256][257]} The public spaces such as halls and dining rooms took a more Indo-European form, and over time many of these spaces became to be considered essential. Functional spaces such as service areas and animal sheds remained traditional in spacial style and basic design.^[258]

²⁴⁰ Issar, *Goa Dourada: The Indo-Portuguese Bouquet*, p.162

²⁴¹ Rangel-Ribeiro, ed., *Goa Aparanta – Land Beyond the End*, p.100

²⁴² Issar, *Goa Dourada: The Indo-Portuguese Bouquet*, p.152

²⁴³ Pandit, *Hidden Hands: Master Builders of Goa*, p.97

²⁴⁴ Issar, *Goa Dourada: The Indo-Portuguese Bouquet*, p.162

²⁴⁵ Pandit, *Hidden Hands: Master Builders of Goa*, p.97

²⁴⁶ Rangel-Ribeiro, ed., *Goa Aparanta – Land Beyond the End*, p.103

²⁴⁷ Pandit, *Hidden Hands: Master Builders of Goa*, p.100

²⁴⁸ Silveira, *Lived Heritage, Shared Space: The Courtyard House of Goa*, p.72

²⁴⁹ Pandit, *Hidden Hands: Master Builders of Goa*, p.104

²⁵⁰ Rangel-Ribeiro, ed., *Goa Aparanta – Land Beyond the End*, p.103

²⁵¹ Issar, *Goa Dourada: The Indo-Portuguese Bouquet*, p.162

²⁵² Rangel-Ribeiro, ed., *Goa Aparanta – Land Beyond the End*, p.95

²⁵³ Issar, *Goa Dourada: The Indo-Portuguese Bouquet*, p.114

²⁵⁴ Pandit, *Hidden Hands: Master Builders of Goa*, p.99

²⁵⁵ Pandit and Mascarenhas, *Houses of Goa*, p.30,32

²⁵⁶ Issar, *Goa Dourada: The Indo-Portuguese Bouquet*, p.162-163

²⁵⁷ Pandit, *Hidden Hands: Master Builders of Goa*, p.97

²⁵⁸ Pandit, *Hidden Hands: Master Builders of Goa*, p.97

Houses built during this period were more spacious and displayed more grandeur than a traditional Goan house.^[259] On the exterior, they had higher plinths, wider fenestration, and intricately deigned verandas and balconies, and thus evolved from being an introvert space to an extrovert space.^{[260][261]} On the contrary, on the interior, the Goan house went on from being a single, multifunctional open space to one with many enclosed rooms.

The **socio-economic strata** that existed before the Portuguese arrived and that which was established by the Portuguese themselves, were reflected in the houses of the inhabitants. The very poor lived in huts made of coconut fronds ('*khop*' in Konkani). The lower and middle class built small to medium size houses, and the rich lived in typical 18th-19th Century mansions. The medium size houses displayed some European influences while the mansion houses borrowed heavily from European designs. After laterite became available, stone structures with mud and/or lime mortars started to be built. Those who could afford to replaced mud structures with laterite.

Generally, most country houses were built by the owners with the help of their neighbours, and mansion houses by builders.^[262] Though the Goan houses had imbibed an European character, there did exist spatial variations between Hindu and Christian houses, the materials and techniques used to build these houses remained indigenous.^[263] This was because they were built by **local builders and carpenters**, who had learnt the craft from their ancestors, who even though may be Christian converts originally belonged to the Hindu lineage.^{[264][265]} Hindu and Christian builders built houses for owners irrespective of religion. Masons also built compound walls and gateposts, and sometimes even made finials.^[266] The best masons are known to have come from Pernem district.

However, the houses in Goa were not only influenced by those in Portugal and other countries of Europe. **Goans who migrated to other parts of India, and other Portuguese and British colonies, especially in Africa brought design and decor ideas from these countries as well.**^[267]

These reasons justify the ongoing debate on whether the 18th-19th houses in Goa are actually '**Portuguese houses**', '**European houses**', '**Indo-Portuguese houses**', '**Indo-European houses**' — or simply '**Goan houses**'.^{[268][269]}

While houses built in the pre-Portuguese and Portuguese era were largely made of natural materials and suited the Goa's climatic conditions,^[270] towards the end of the Portuguese period, a few 'modern' and 'contemporary' structures had sprung up.^[271]

POST-LIBERATION

After the Portuguese left Goa in 1961, Goans took on the Indian identity but also became more conscious of their distinct Goan identity. They felt the to express and preserve it and did so through music, art, architecture, etc. which displayed an "Indian yet Goan" character.^[272] 'Goanness' in still evolving and so is Goan architecture.^[273]

This period also saw opportunists give rise to more constructions. As architects either came from Mumbai or received training there (architecture school in Goa was founded later in the 1980s), building with apartments started sprouting in the cities. This changed the architectural and social fabric of the Goa, as even those with comfortable houses in the villages started moving into apartments in order to avail themselves of better facilities in the cities. Gradually, tiled roofs of individual houses began to be replaced by reinforced cement-concrete terraced roofs.^[274] Goans working in the Gulf also came back with money and often constructed swanky bungalows that lacked taste and were overtly decorated. In 1970s, international style architecture, which lacked regional cultural references started making its presence but was unable to carve a niche for itself in Goa.^[275]

²⁵⁹ Issar, *Goa Dourada: The Indo-Portuguese Bouquet*, p.162-163

²⁶⁰ Munj, *Colour in Architecture – Perception of Colour in Spatial Environment in Context of Goa*, p.47

²⁶¹ Silveira, *Lived Heritage, Shared Space: The Courtyard House of Goa*, p.80

²⁶² Pandit, *Hidden Hands: Master Builders of Goa*, p.114

²⁶³ Silveira, *Lived Heritage, Shared Space: The Courtyard House of Goa*, p.69-70,72

²⁶⁴ *Ibid.*, p.72

²⁶⁵ Rangel-Ribeiro, ed., *Goa Aparanta – Land Beyond the End*, p.100

²⁶⁶ Pandit, *Hidden Hands: Master Builders of Goa*, p.104

²⁶⁷ Pandit, *Hidden Hands: Master Builders of Goa*, p.32

²⁶⁸ Issar, *Goa Dourada: The Indo-Portuguese Bouquet*, p.152

²⁶⁹ Menezes, "'Portuguese architecture' in Goa has little to do with the Portuguese and everything to do with Goa," November 13, 2017,

<https://scroll.in/magazine/856585/portuguese-architecture-in-go-a-has-little-to-do-with-the-portuguese-and-everything-to-do-with-go-a> (accessed August 23, 2019)

²⁷⁰ Pandit, *Hidden Hands: Master Builders of Goa*, p.129

²⁷¹ Rangel-Ribeiro, ed., *Goa Aparanta – Land Beyond the End*, p.112

²⁷² *Ibid.*

²⁷³ *Ibid.*, p.112,117

²⁷⁴ *Ibid.*, p.113

²⁷⁵ Rangel-Ribeiro, ed., *Goa Aparanta – Land Beyond the End*, p.116

Today, apartment buildings and individual houses have only proliferated and reckless development continues to change Goa's fabric. Goa is attracting real-estate builders and buyers from other parts of India, which has caused property prices to rise. In addition, A few Goans are choosing to sell off their ancestral house and divide the money among the heirs as a means to ease the responsibility of maintaining the house and dividing the property among its inheritors; this is usually in cases of massive houses with several heirs. Many Goans are choosing to demolish their ancestral houses, so that the plot can be divided between the inheritors, each of whom can construct individual houses. As many families' economic situation has elevated, especially as a result of working in foreign countries, it has become an obvious choice to demolish their old earthen houses, whether big or small in size, and reconstruct them using laterite-and-cement. This is because there is a general impression that earthen houses are not solid, whereas laterite-and-cement constructions are better and long-lasting. There have also been situations where people have pulled-down the roof and let the rain melt down their earthen house, in order to avoid the hassle of seeking permission for demolition. While there are those who are benefiting from this scenario, there are others — activists, historians, laymen included — who are working towards protecting Goa's cultural identity and future interest.

Structures built with laterite-stone and cement-mortars are common place in Goa today, and cement-blocks have started to appear. Eco-alternatives such as exposed laterite houses are mud-houses are also making a come back.

4. SURVEY — GOA

4.1. REGIONS SELECTED FOR STUDY

Sixteen case-studies were conducted in Goa. They were concentrated in three 'talukas' (administrative divisions). The reasons for selecting these regions is explained in the methodology (Refer section '2.2.2. Selection of structures').

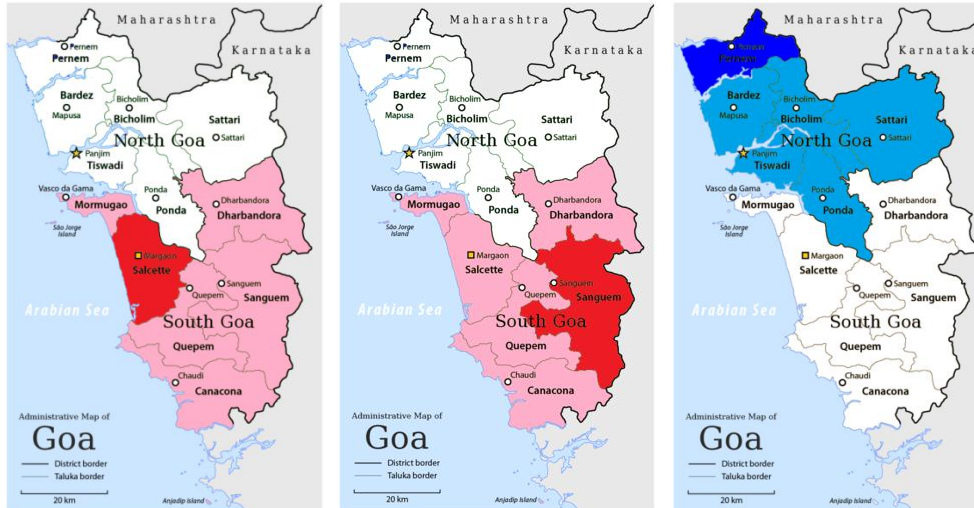

Image 63: Location of Salcete 'taluka', South Goa district.

Image 64: Sanguem 'talkuka', South Goa.

Image 65: Pernem 'taluka', North Goa.

[Source: Inshaan Shah62, Wikipedia]

- Salcete 'taluka', South Goa district.
Villages where the structures were located
Colva: Survey nos. 1, 2, 4, 5, 6, 7, 8.
Benaulim: Survey nos. 3a, 3b.
Majorda: Survey nos. 9, 11.
Seraulim: Survey no. 10.
- Sanguem, South Goa.
Villages
Salgini: Survey nos. 12, 13.
Neturlim: Survey nos. 15.
- Pernem, North Goa.
Village
Dhargalim VP: Survey no. 14.

4.2. LOCATIONS OF BUILDINGS SURVEYED AND CASE-STUDIES



Image 66: Location of buildings surveyed in Goa.

SURVEY NO. 1

IDENTIFICATION

District: South Goa.

Taluka: Salcete.

Village: Colva.

Owner(s) / Tenant(s): Tedoline Coutinho

No. of inhabitants: Five i.e. Tedoline and her four sons. Three of her sons work abroad or on cruise liners.

Address: H. No. 37, first ward, Colva, Salcete, Goa — 403708.

Construction technique(s): Likely to be cob (called '*mathe ghor*' in Konkani. Its literal translation is 'house built with earth').

Visited on: 27/05/2018.

BUILDING DATA

CHRONOLOGICAL DATA

Construction date: Built during Tedoline's parents-in-laws' generation or before.

Builder: Unknown.

Original use: House.

Present use: House.

History of the building: The building was built by Tedoline's husband, Vexentino's ancestors. Vexentino passed away a few years back.

Restorations and/or interventions: There is a temporary structure at the rear of the house. The entrance doors on the front and back of the house were replaced in 2017. 'Country-tiles' (*'gauntti nole'* or *'barke nole'* in Konkani) were replaced with 'Mangalore-tiles' a couple of years ago. The front and back entrance doors were replaced about a year ago. The floor of the porch was covered with a layer of cement + sand about 4-5 months back. In 2019, Tedoline's eldest son got married and the house was completely renovated. It was plastered using lime bought from the market, and the floors were covered with flooring sheets.

Building in use or not: Still in use.

Building at risk: No.

Information given by: Owner.

Other important data:

Perspectives of the building



Earth used & Typology



TECHNICAL DATA

Base-course: 17cm along north facade, 14cm along south wall facade; in earth.

Flooring: Cow-dung ('shen' in Konkani), except front porch.

Buttresses: No.

Corners: In earth and laterite. A laterite-stone sits above the earthen base-course, visible on south-east and north-west facade corners.

Openings: Two doors, three windows, and vents on front facade.

Roof type: 'Mangalore-tiles'. 78cm overhang (includes palm-leaf overhang).

Thickness of exterior walls: 45cm.

Distinct architectural details:

Observations: Circular blotches of lime on north and south facades.

TYPOLOGICAL DATA (rammed-earth / cob)

Description of earth used: Light yellowish-brown in colour, sandy. Similar for mortars.

Dimensions of 'lifts': (In English, a layer of earth in earthen constructions is referred to as a 'lift'; in this context, if layers exist within a 'lift' they are often simply called 'layers'. In Konkani, a 'lift' is called 'parro'.) 'Lift' heights vary from one 'lift' to the other, as well as from one end of the 'lift' to the other end. The heights from wall-base to top: 45cm, 56cm, 64cm, 64cm, 51cm (north facade); 45cm, 59cm, 53.5cm, 60cm (south facade).

Mortars: In earth; 3-4cm along vertical joints, and 3-5cm along horizontal joints of laterite-stone masonry only.

Plasters, pigments and/or paints: No plaster on north and south facades. Main facade has a 0.3cm plaster comprising three layers: the lowermost and thickest is lime, followed by a layer of a grey unidentified material, and the top is coated in light-blue (exterior). Similar plaster composition in the hall. There is a coat of lime on kitchen and storeroom walls (interior).

Distinct characteristics:

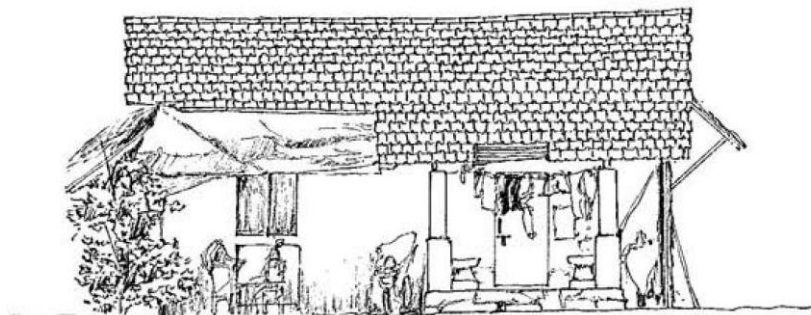
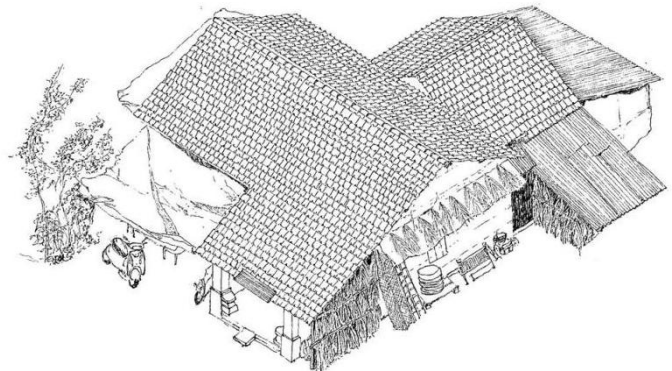
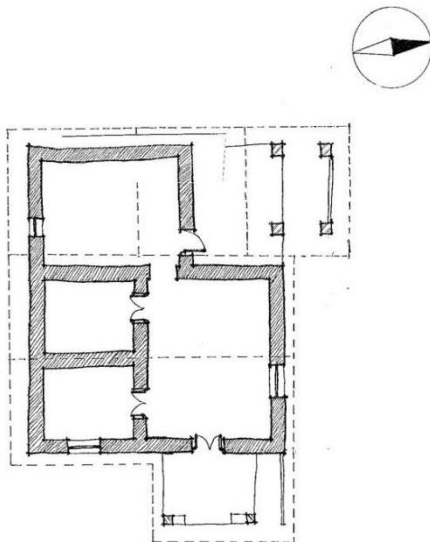

[Drawings by Lionel Afonso, 2018-2019]



(In 2018)



(In 2019)

This house was renovated in 2019 before the wedding of the eldest son, Agnele.



Damages incurred / problems faced: Mason-bee holes.



Damages incurred / problems faced: Plasters flaking and falling-off.



Palm-leaf barrier along walls ('dollo').

Palm-leaf overhang ('pakadi').

Maintenance and repairs: Woven coconut-palms ('molla'), palm-leaf barriers ('dollo'), and overhangs ('pakadi') are used to protect walls from rainwater.



Maintenance and repairs: A woven coconut-frond ('molla') protects the gable from the sprays of rainwater.

CARE AND CONTINUITY

CONDITION ASSESSMENT

Damages incurred / problems faced:

Some years ago, a coconut tree fell and broke the roof-tiles on north-east corner. Cracks (*'funt'* in Konkani) have developed especially in corners. They got wider with time, and created openings in the walls. A snake once entered the house through the wide crack along south-west kitchen corner.

Observations: Roof overhang on main facade slightly damaged, mason-bee holes on north and south facades, plasters flaking and falling-off, interior kitchen walls have darkened because of smoke, floor chipped in some places.

MAINTENANCE AND REPAIRS

Preventive conservation:

Periodic interventions: In order to protect walls from rainwater, every year before the monsoons, they used to weave coconut-palm-leaves and hang them on facades, build palm-leaf barriers along walls, and set-up palm-leaf overhangs over windows. (In Konkani, woven coconut-palms are called *'molla'*, palm-leaf barriers along walls *'dollois'*, and overhangs are called *'pakadi'*.) Fresh layer of cow-dung was applied occasionally.

Repairs: Some cracks were filled with cement.

Observations: A woven coconut-frond protects the rear gable. A tarpaulin (*'capot'*; it also means 'raincoat' in Konkani) protects walls and palm-leaf protections that were made years ago. Interestingly, the tarpaulin is secured in place using nails, and empty plastic tubes and bottle caps instead of washers. Coconut palm-leaf petioles (*'pedo'* in singular form, *'pedé'* for plural, in Konkani) are placed against the tarpaulin to prevent it from flying with the wind.

Other information:

Challenges faced today: Tedoline is no longer able to continue with house-maintenance with the same zeal as before. Every year, she and her husband used to make the rainwater barriers i.e. *'mollas'*, *'dollois'* and *'pakadis'*, but since he died, she has had no help and has not been able to continue the same. Back then, her husband, Vexentino used to source the cow-dung for re-layering the floor. Later, Zuzeb (passed-away), their tenant who lived in the rear extension would do so.

Tedonlina related that the house is not in a good shape any more. During the monsoons, raindrops hitting the roof-tiles accompanied with thunder and lightning make a lot of noise, which makes it scary to live in the house. So for the last couple of years, she has been living at a relative's house during the rainy season.

Future plans: The family does not want to invest in repair of the house because they are yet to obtain ownership status. The landlord is in the process of compensating them. (As mentioned in the introductory chapter, the Goa Mundkars Protection from Eviction Act 1975 entitles tenants to a plot of land, provided they fulfil the required criteria.) Depending on whether they will be allotted the same plot or another one in the vicinity, they intend to (re)construct a new house with laterite-stone and cement.

SURVEY NO. 2

IDENTIFICATION

District: South Goa.

Taluka: Salcete.

Village: Colva.

Owner(s) / Tenant(s): Braganza family.

No. of inhabitants: The house has four heirs. None of them live in the house, they live in other parts of Goa or abroad.

Address: H. No. 35, first ward, Colva, Salcete, Goa — 403708.

Construction technique(s): Cob.

Visited on: 27/05/2018.

BUILDING DATA

CHRONOLOGICAL DATA

Construction date: It was built in Romeo's grandmother's generation.

Builder: Romeo's mother's brothers, when they were about 20 years old.

Original use: House.

Present use: House.

History of the building: The house belonged to Romeo's maternal grandmother. He lived in Kuwait with his parents and siblings, and moved into this house when he was 18 years old; his family members joined later. In 2001, he shifted to Navelim in the suburbs of Margao town, also in South Goa.

Restorations and/or interventions: There used to be an earthen pillar on the inside. The interior walls and east facade were plastered (there was no plaster before), ventilation fans were installed, cow-dung floors were redone with rubble and cement between 1991-1994. These renovations were done in preparation of Romeo's sisters wedding. More recently, the west wall and a part of the south wall were reconstructed with laterite-and-cement.

Building in use or not: Family members do not live in the house but continue to visit it.

Building at risk:

Information given by: One of the heirs, Romeo Braganza, 40+ years old.

Other important data: Romeo recalls that the temperature inside the earthen-house was always lower than that on the outside. They did not need ventilation fans as the coolness effect was as good as that of an air-conditioner. When sleeping at night, the mattresses on beds provided warmth. He added that cow-dung floors were good for health; people had fewer health problems then.

He also remembers seeing a house in Saligao in North Goa, where coconut husk was dipped in a mud + water mix and lightly brushed in upward motion along the 'lift' lines. This was also done to fill cracks, probably to have neat looking walls.

Romeo was the only one from those interviewed in Goa for this study who recollected a Konkani song that mentions houses. The song lyrics include '*Taka ek paklo choita, paklo choita, burkan ghalulnum tonddo.*' (A European man is peeping through a hole (in the wall of the house), looking at her with his face (lit)). Considering the period in which this song was popular, he attributed that the lyrics refer to a hole in a mud wall. (This house could not be accessed on the inside as nobody lives there. However, Romeo, one of the owners was in Goa on vacation and shared the information.)

Perspectives of the building



Earth used & Typology



TECHNICAL DATA

Base-course: 20cm; unclear whether it is earth, or laterite-and-earth masonry.

Flooring: Cement.

Buttresses: None.

Corners: In earth or laterite masonry.

Openings: Two doors and one window.

Roof type: 'Mangalore-tiles' and metal-sheets ('potré' in Konkani). 83cm overhang on north side, and 44cm on east.

Thickness of exterior walls: 45cm.

Distinct architectural details:

Observations: Base-course is greyish along the bigger north facade. Some parts of the wall are exceptionally smooth. Some corners are built with earth, and some in laterite masonry. The laterite masonry has earthen or cement mortars. Hence, it is hard to say whether the laterite masonry in the corners is part of the original construction or a later addition.

TYPOLOGICAL DATA (rammed-earth / cob)

Description of earth used: Deep red in colour, clayey. Presence of laterite rubble. Roof-tile pieces spotted.

Dimensions of 'lifts': 'Lift' heights differ from one 'lift' to the other; heights even vary along the same lift. The heights from wall-base to top: 20cm, 55cm, 49cm, 53cm, 48cm, 15cm (bigger north facade); 54cm, 50cm, 34cm (smaller north facade). 53cm, 50cm, 49cm (south facade).

Mortars: Earthen and cement mortars in laterite masonry. Widths of earthen mortars are uneven.

Plasters, pigments and/or paints: A coat of lime or paint on south facade; cement-plaster on east wall (exterior). (Interior) walls plastered.

Distinct characteristics:

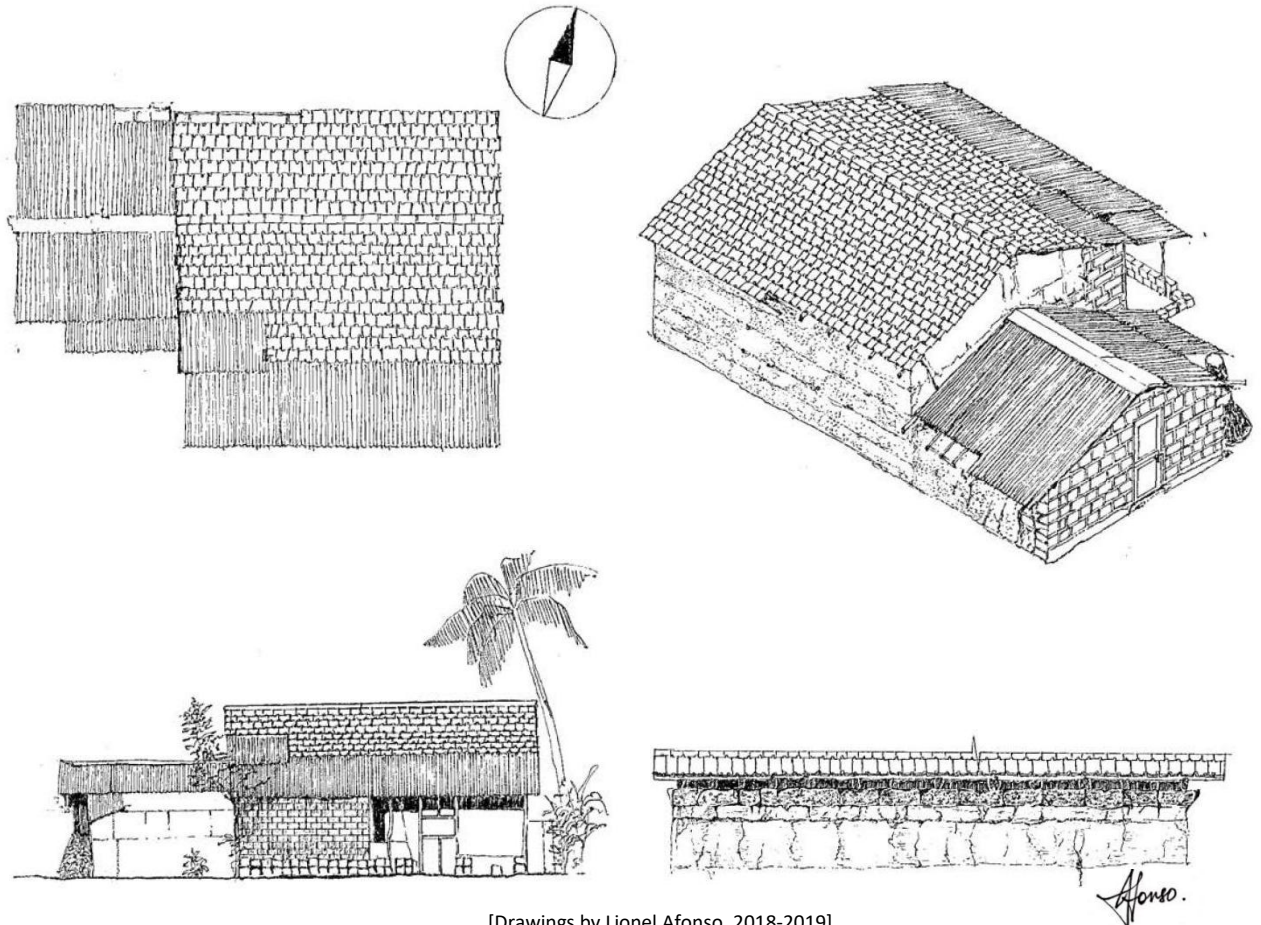

[Drawings by Lionel Afonso, 2018-2019]



Observations: Base-course is greyish along the one facade.
Repairs: Cracks and other repairs done in cement.



Observations: Some parts of the wall are less eroded than the others.



Observations: The laterite masonry in the corners has earthen or cement mortars. It is hard to say whether these corners are part of the original construction or a later addition.



Plasters: A coat of lime or paint on south facade.



Damages incurred / problems faced: Mason-bee holes



Observations: A make-shift lean-to aids in protecting facade walls from rain water. Simple branches are used to support the roof of the lean-to.

CARE AND CONTINUITY

CONDITION ASSESSMENT

Damages incurred / problems faced:

Roof-tiles would crack if coconuts fell or animals climbed on them, or even due to too much heat. Once, a damage in the roof led to water ingress and subsequently a crack in the north wall.

Observations: Parts of roof are damaged, cracks on walls, smaller north facade is more eroded than the bigger one, mason-bee holes.

MAINTENANCE AND REPAIRS

Preventive conservation:

Periodic interventions:

Roof: Romeo remembers that when the house had country-tiles, the roof work was done every year. An old, abraded stick-broom (brooms made with midribs of coconut frond leaflets, they are common in Goa, and are called '*iria san*' in Konkani) was used to clean the roof. The wooden framework was repaired. The tiles were removed and rearranged in order, and in the process, broken tiles were thrown away. Thus every year, on reaching the last row, tiles would fall short and new ones were fixed.

Flooring: A fresh layer of cow-dung was applied periodically. How often this had to be done depended on the number of people living in the house i.e. the number of footfalls. When his grandmother lived alone, she would re-layer the floor every six months.

Repairs: Cracks and other repairs done in cement.

Observations: A make-shift lean-to aids in protecting facade walls from rain water. Simple branches are used to support the roof of the lean-to.

Other information: Romeo remembers that it would be get really scary to stay in the house when there were exceptional heavy rains showers. It used to feel like the walls would fall. He remembers a neighbour once coming to his house with an umbrella, when it was pouring heavily, to invite them to stay at their house till the rains calm down.

Challenges faced today: If the roof started leaking during the monsoons, one had to then wait till the monsoons end to repair it because if you try to climb the roof when the tiles were still damp, the tiles would break easily. A roof mason had to be hired every time the roof needed repairs.

Future plans: Reconstruction in laterite-and-cement is pending.

SURVEY NO. 3a

IDENTIFICATION

District: South Goa.

Taluka: Salcete.

Village: Benaulim.

Owner(s) / Tenant(s): Aurea Coutinho and her siblings. The ancestral owners were their mother, Trinade Rodrigues Coutinho (passed-away in 2004), and maternal grandmother, Conceição Maria C. Rodrigues (passed-away).

No. of inhabitants: One, Aurea.

Address: H. No. 122, Manzil Vaddo, Benaulim, Goa — 403716.

Construction technique(s): Cob.

Visited on: 27/05/2018.

BUILDING DATA

CHRONOLOGICAL DATA

Construction date: 1940s. (It was carved on the lintel of the entrance door, can't be seen after refurbishment.)

Builder: The master-craftsman was a neighbour called Custodio (Aurea recalls him vaguely). He was a mason and a carpenter as well. The masons were hired by Conceição, and Aurea's great-grandfather used to come from Cansaulim village to supervise the construction. The shop-cum-bar extension was built with laterite-and-cement by masons hired by Trinade.

Original use: House + agricultural purpose.

Present use: House + room for lease.

History of the building: Aurea recalls the history from what was told to her by her mother and grandmother. The soil for the construction of the house was sourced from a neighbouring pond called 'Hai Gairo' ('Gairo' is a local pond); it was a blackish sticky mud. Aurea's family moved into the house on the day she received her First Holy Communion, when she was about seven years old. A shop-cum-bar (called 'gadi' in Goa) was later added, and Trinade managed the bar from 1968-1982. It was later leased-out to tenants who operated it till 2003. The tenants began claiming ownership rights to the bar but the court-case ended in favour of the Coutinho family in 2006.

Restorations and/or interventions: Before, the balcony had pillars and front seats only. Side seats and balusters were added later. The shop-cum-bar extension was added in 1967-68. The hall and bedroom were plastered with cement, and the roof beam in the bedroom which was giving away was changed after 2004. Floor-tiles in the hall were laid a few years back; red-oxide flooring was done in the dining-room a couple of years back, and in kitchen and storeroom in February 2017.

Building in use or not: Still in use.

Building at risk: No.

Information given by: Aurea Coutinho, one of the owners.

Other important data: Aurea vaguely remembers that a neighbour called Pedro Santana Fernandes (passed-away after 1987) used to come to repair the walls of the house as and when needed. Aurea does not remember seeing a mud-house being built in her lifetime. She lived in Bahrain with her family when she was a child and visited Goa on vacation. She later did her schooling in Mysore in South India, after which she moved to Goa for good.

Perspectives of the building



Earth used & Typology



TECHNICAL DATA

Base-course: Approximately 27cm with 2-3cm setback; in laterite-and-earth masonry.

Flooring: Chip-tiles in hall; red-oxide in dining-room, kitchen and storeroom; cement in bedroom; cow-dung in bedroom-converted-to-storeroom.

Buttresses: No.

Corners: In laterite-and-earth masonry. The north-west corner is in earth.

Openings: Four doors, five windows, and some vents.

Roof type: 'Mangalore-tiles'. 50cm overhang.

Thickness of exterior walls: 45cm.

Distinct architectural details: Wooden pillar in the veranda. Kitchen wall is partly built in laterite-masonry, whereas the hall is not. (Back then, service rooms such as kitchens and storerooms were built with less expensive materials as compared to halls and bedrooms.)

Observations:

TYPOLOGICAL DATA (rammed-earth / cob)

Description of earth used: Yellowish colour, lot of laterite and other stone rubble.

Dimensions of 'lifts': 'Lift' heights vary from one another and from one part if the 'lift' to the other. The heights from ground to up: 69cm, 48cm, 59cm, 46cm, 66cm (north facade); 42cm, 50cm, 45cm, 34cm, 40cm (east facade); 38cm, 23cm, 50cm (south facade).

Mortars: Earth mortars with lime ('chuno' in Konkani) re-pointing on laterite masonry. 1-2cm along vertical joints and 3cm along horizontal joints on north facade. Approximately 4cm along vertical joints of and 1-3cm along horizontal joints of south facade.

Plasters, pigments and/or paints: Only facade wall plastered and painted in blue (exterior). All walls plastered (interior). Hall, bedroom, dinning in cement. Decorative elements of the veranda, and doors and windows of plastered facades are bordered with a bright-blue oil paint — except the kitchen and storeroom (exterior and interior).

Distinct characteristics:

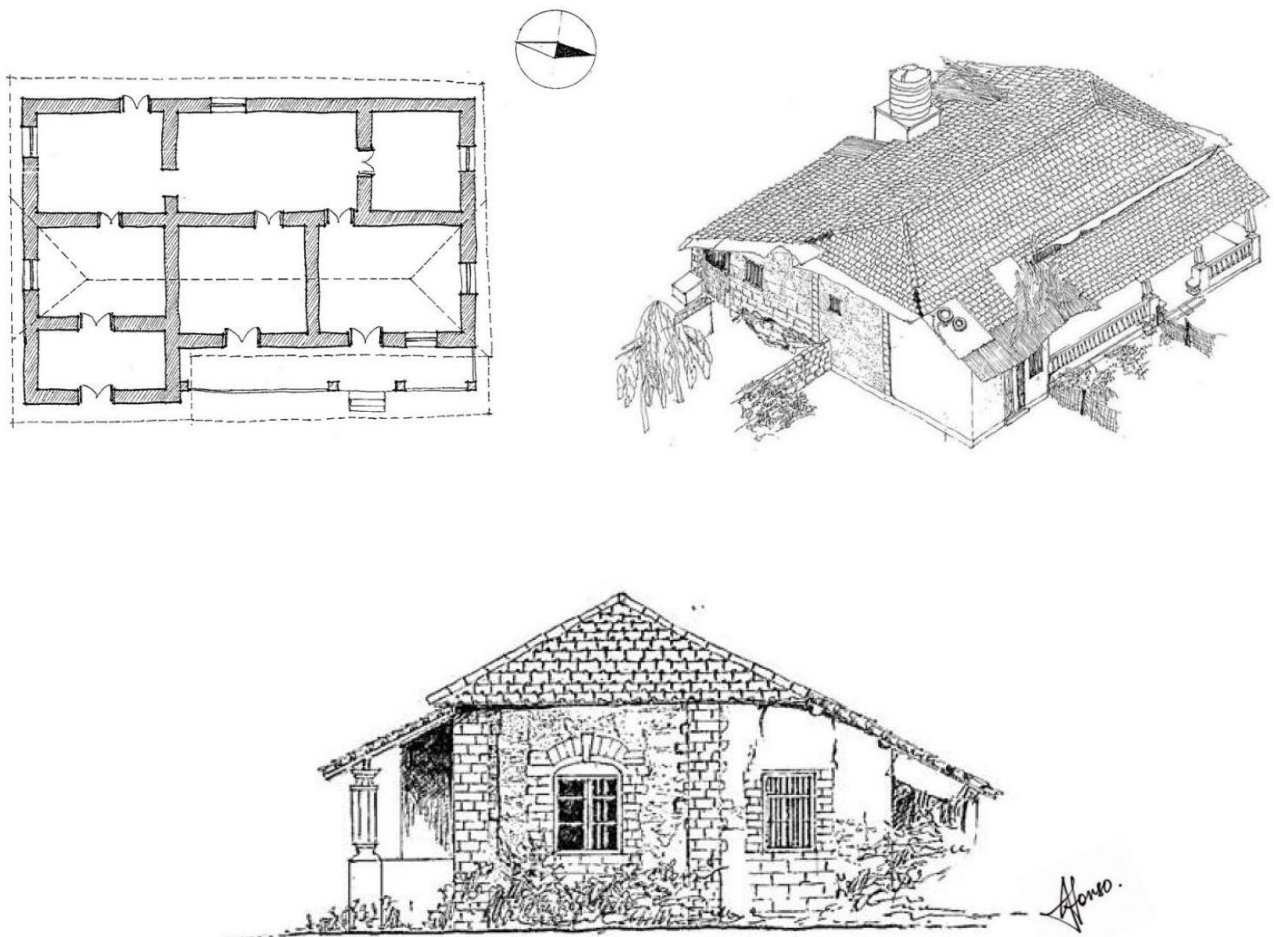

[Drawings by Lionel Afonso, 2018-2019]



Rear view.



Distinct architectural details: Wooden pillar in the veranda.



Distinct architectural details: Kitchen wall is partly built in laterite-masonry, whereas the hall is not. (Back in time, service rooms such as kitchens and storerooms were built with less expensive materials as compared to halls and bedrooms.)



Damages incurred / problems faced: Cracks on internal walls.



Damages incurred / problems faced:
Chip-tiles are chipped-off.



'menki matti' (a type of earth).

Maintenance and repairs: Crack filled-up with 'menki matti'.

CARE AND CONTINUITY

CONDITION ASSESSMENT

Damages incurred / problems faced:

Rafters get damaged when rainwater leaks into the house. Dust frequently falls from the roof framework, and needs to be cleaned often. If there is no one in the house for a few days and the house is closed, the gathering of the dust gets much worse.

There are cracks on internal and external walls, which got wider especially in case of earthquakes.

Observations: Water run-off on east wall, oyster shell windows are not in a good condition, the floor in the hall has a hole and the chip-tiles are chipped-off.

MAINTENANCE AND REPAIRS

Preventive conservation:

Periodic interventions: The roof-tiles are cleaned sometimes.

Repairs: Some years ago, cracks on the west wall were filled-up with 'menki matti' (a type of earth). Just before 2004, some other cracks were covered with cement.

Observations: Some cement repairs.

Other information: Aurea's nephew tries to take care of the maintenance in whatever way he can.

Challenges faced today: The roof is too high and it is hard to find people who are willing to repair it.

Future plans: The house has many heirs, so it is hard to say what its future will be.

SURVEY NO. 3b

IDENTIFICATION

District: South Goa.

Taluka: Salcete.

Village: Benaulim.

Owner(s) / Tenant(s): Aurea Coutinho and her siblings. The ancestral owners were their mother, Trinade Rodrigues Coutinho (passed-away in 2004), and maternal grandmother, Conceição Maria C. Rodrigues (passed-away).

No. of inhabitants:

Address: H. No. 122, Manzil Vaddo, Benaulim, Goa — 403716.

Construction technique(s): Cob.

Visited on: 27/05/2018.

BUILDING DATA

CHRONOLOGICAL DATA

Construction date:

Builder:

Original use: Compound wall.

Present use: Dividing wall.

History of the building: The compound wall was longer before. It covered the old outdoor toilet, and enclosed the vegetable garden. The part that remains is just a portion of the original wall.

Restorations and/or interventions: The two ends were rebuilt with stone; one before 2004 and the other after 2007.

Building in use or not: Still in use.

Building at risk:

Information given by: Aurea, one of the owners.

Other important data: Aurea vaguely remembers that a neighbour called Pedro Santana Fernandes (passed-away after 1987) used to come to do minor repairs and touch-ups to the compound wall as and when needed.

Perspectives of the building



Earth used & Typology



TECHNICAL DATA

Base-course: In laterite-and-earth masonry.

Flooring:

Buttresses: No.

Corners:

Openings:

Roof type: 'Country-tiles' and 'Mangalore-tiles'. 30cm overhang (includes 17cm overhang with 'country-tiles').

Thickness of exterior walls: 43cm.

Distinct architectural details:

Observations:

TYPOLICAL DATA (rammed-earth / cob)

Description of earth used: Light-yellow, sandy. Presence of rubble, lime pieces, roof-tile pieces.

Dimensions of 'lifts': 'Lifts' not clear.

Mortars: 3-6cm along vertical joints, and 3-4cm along horizontal joints of laterite-stone masonry.

Plasters, pigments and/or paints: No plaster.

Distinct characteristics:

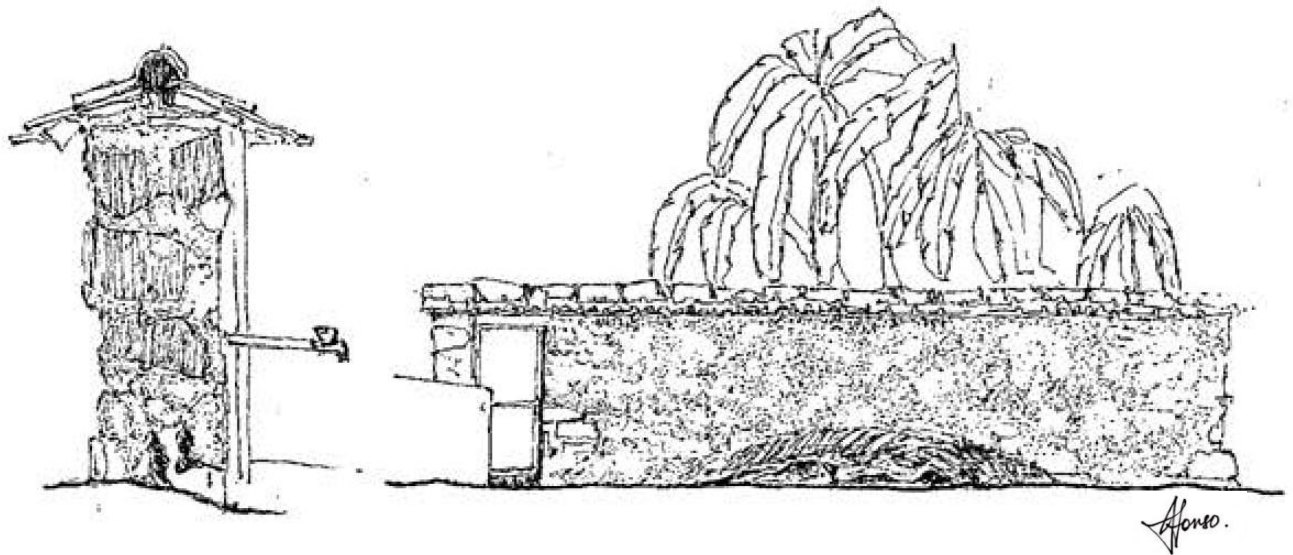

[Drawings by Lionel Afonso, 2018-2019]



Front view of the wall.



'Country-tiles'. 'Mangalore-tiles'.

Roof type: 'Country-tiles' and 'Mangalore-tiles'.



'Country-tiles'. 'Mangalore-tiles'.

Roof type: 'Country-tiles' and 'Mangalore-tiles'.



Damages incurred / problems faced: Mason-bee holes on the repaired part.



Maintenance and repairs: 'Menki-matti' (type of mud) used to touch-up the wall.



CARE AND CONTINUITY

CONDITION ASSESSMENT

Damages incurred / problems faced:
(Refer 'Repairs' section.)

Observations: The south end facing the vegetable garden is quite badly eroded, mason-bee holes.

MAINTENANCE AND REPAIRS

Preventive conservation:

Periodic interventions: The roof-tiles had to be reset every year (it requires less frequent intervention since repairs were done).

Repairs: Some years back, the earth on the wall started loosening on its own, and the wall started collapsing. So old 'Mangalore-tiles' were replaced with new ones. Mud from the broken portion of the wall or 'menki-matti' (type of mud) was used to touch-up the part that remains.

Observations:

Other information: 'Mangalore-tiles' require lesser regular maintenance than 'country-tiles'.

Challenges faced today:

Future plans:

SURVEY NO. 4

IDENTIFICATION

District: South Goa.

Taluka: Salcete.

Village: Colva.

Owner(s) / Tenant(s): Shau and Savita (Mangal) Panchvartan.

No. of inhabitants: Two, husband and wife.

Address: H. No. 38, first ward, Colva, Salcete, Goa — 403708.

Construction technique(s): Likely to be cob. Gables and kitchen of adobe-bricks (referred to as 'box' in Konkani).

Visited on: 27/04/2018.

BUILDING DATA

CHRONOLOGICAL DATA

Construction date: It was built in Shau's grandfather's generation. (Also refer 'Restorations and/or interventions' section.)

Builder: Shau's grandfather built the house, Shau built the North and South gables, and Mangal built the kitchen walls.

Original use: House + basket-weaving workshop.

Present use: House + basket-weaving workshop.

History of the building:

Restorations and/or interventions: The laterite-and-cement pillars (pillars are called 'pegão' in Konkani) were added because the walls needed support, the 'sopo' (traditional seats in the veranda) was built in the lean-to, cement was applied on the South wall using bare hands, and the previous palm-leaf roof was replaced with roof-tiles. These modifications were made in preparation of Shau and Mangal's wedding.

About 25 years back, Shau added the North and South adobe-bricks gables. He sourced the mud from a nearby construction site, when his neighbour, Jack Rodrigues was a building a house. He made the adobe frame with 'pedi' (a type of wood) and nails. The mud was mixed with water, and immediately moulded into bricks. The bricks were left to dry in front of Shau's house for about 8-9 days. The same mud was used as mortars while laying the adobes.

About 2-3 years back, the old, palm-leaf kitchen was rebuilt in mud by Mangal. She sourced the mud from the surroundings of the house, mixed it with water, and on the following day, moulded them into bricks. They were dried outside the house for about 4-5 days. The same mud was used as mortars.

Just before the rains, a temporary, palm-leaf shelter is usually built at the rear of the house to store firewood.

Building in use or not: Still in use.

Building at risk: No.

Information given by: The owners, Shau and Mangal.

Other important data: The opening in the North gable is because the adobe-bricks fell short. There is a (piece of) fired brick in this gable.

Shau is a basket-weaver by profession. He also takes-up other jobs such as masonry, selling flowers and candles during festivals, etc. The family is originally from Sanvordem in South Goa and has a house there. In Sanvordem, there are many rammed-earth ('taip' in Konkani) constructions. The couple believes that living in an earthen-house is good for health.

Perspectives of the building



Earth used & Typology



TECHNICAL DATA

Base-course: 20cm high on West facade and 11-26cm on East; in laterite-and-earth masonry. On the East, the stones are uneven in shape and size, and hence the variation in height. The base-course has a setback of 6-12cm; the variance could be because in some parts of the wall, the soil has eroded off.

Flooring: Cow-dung.

Buttresses: None.

Corners: In laterite-and-cement masonry (not original).

Openings: A door, a window and a vent.

Roof type: 'Mangalore-tiles', tarpaulin and palm-leaves. 1.1m (includes extension) overhang on West side. 1.04m on East i.e. 71cm of tiles and 35cm palm-leaf extension.

Thickness of exterior walls: 47cm.

Distinct architectural details:

Observations: The opening in the North gable is because the adobe-bricks fell short. There is a (piece of) fired brick in this gable.

TYPOLOGICAL DATA (rammed-earth / cob)

Description of earth used: The mud used to make the walls is light yellowish-brown in colour. It is sandy and includes shells, laterite rubble, pebbles, lime and roof-tile pieces. The earth used for the bricks is a darker shade of yellow and has more clay.

Dimensions of 'lifts': 'Lift' heights vary, even along the same 'lift'. Heights from wall-base to top: 28-33cm, 28-36cm, 33cm, 33cm, 27cm, 16cm on the West facade (Size variations are mentioned because 'lift' heights are uneven and vary along the same wall).

Mortars: Earthen mortars in base-course and gables. About 2.5cm (varies) along horizontal joints of base-course. 7-8cm along horizontal joints of South gable. Approximately 2.5cm along vertical joints and 6-7cm along horizontal joints of North gable.

Plasters, pigments and/or paints: No plaster, except cement-plaster on front facade (exterior). In some parts, lower walls are plastered with cow-dung up to a height of 27-30cm (interior).

Distinct characteristics: Gables are built with adobe-bricks: 24cm (length) x 14cm (height), 30cm x 14cm, 34cm x 14cm (varied lengths). The adobe-bricks are moulded in frames, yet their lengths vary.

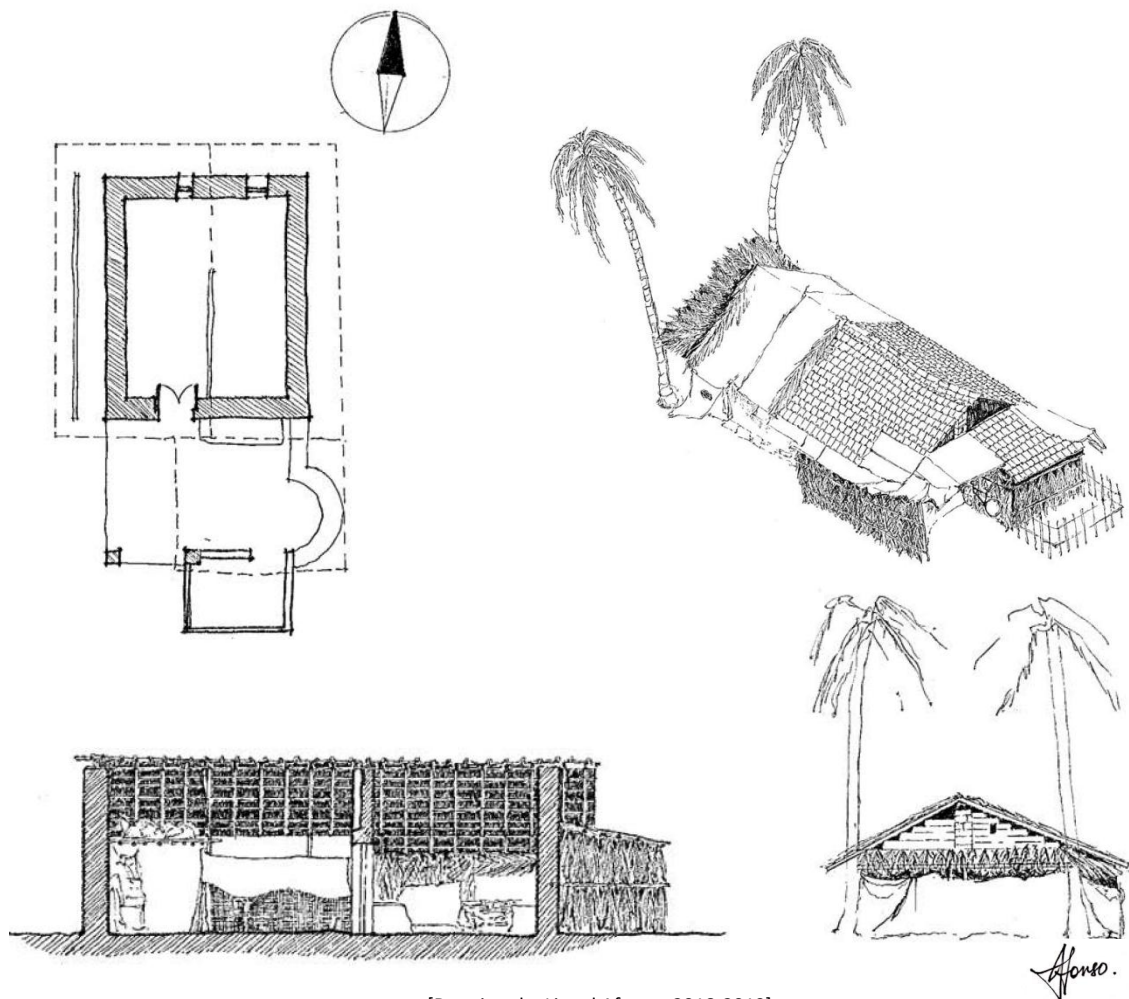

[Drawings by Lionel Afonso, 2018-2019]



Flooring: Cow-dung.

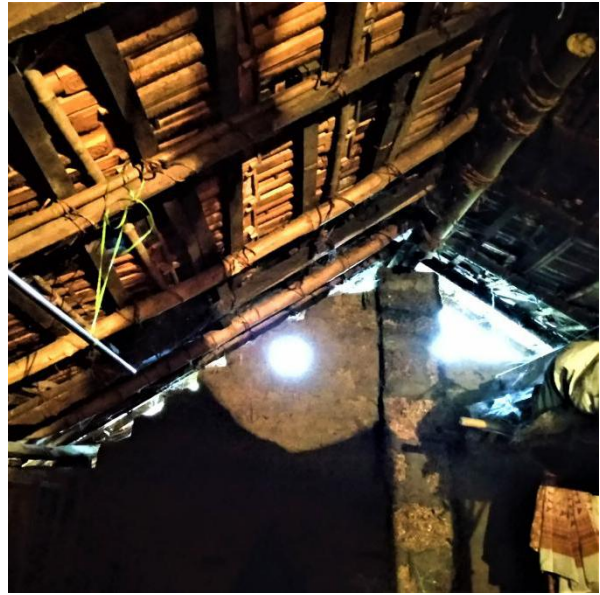

Openings: Vent in the adobe-brick gable.
The opening in the North gable is because the adobe-bricks fell short while building.



Observations: There is a (piece of) fired brick in the adobe-brick gable.



Damages incurred / problems faced: A crack in the roof caused rainwater to seep into the walls and created a hole in the corner.



Damages incurred / problems faced: Erosion of the walls has created depressions above base-courses of external walls.

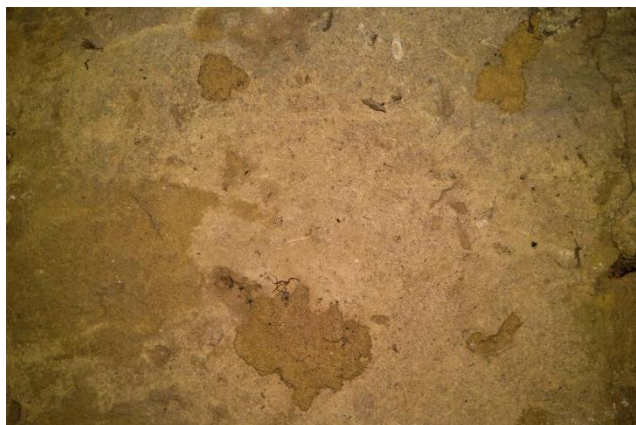

Damages incurred / problems faced: Insects have built earthen-nests on interior walls.

CARE AND CONTINUITY

CONDITION ASSESSMENT

Damages incurred / problems faced:

A crack in the roof caused rainwater to seep into the walls and created a hole on the north-east corner; roof problems have also damaged kitchen walls. Erosion of the walls has created depressions above base-courses on east and rear facades. Cracks, and holes created by rats, especially on kitchen walls. Insects have built earthen-nests on interior walls. Blackened kitchen walls due to smoke from wood-burning-stoves.

Observations: Chipping and holes in walls, including mason-bee holes. Wall slightly bulging on East facade.

MAINTENANCE AND REPAIRS

Preventive conservation:

Periodic interventions: The roof is repaired every two years, earthen-nests built by insects are broken manually, fresh layer of cow-dung is applied every 2-3 months.

Repairs:

Observations: A hole at the foot of the exterior rear wall was filled-up using a dried coconut (*'bondo'* in Konkani) and mud. Palm-leaf barriers and extended overhangs (made with palm-leaves and tarpaulin) are erected to prevent rainwater from damaging walls.

Other information:

Challenges faced today:

Future plans: The landlord has not made it clear whether he will be allotting them a piece of land. So till then, the couple does not intend to invest in repairs.

SURVEY NO. 5

IDENTIFICATION

District: South Goa.

Taluka: Salcete.

Village: Colva

Owner(s) / Tenant(s): Antonio Menino Fernandes.

No. of inhabitants: One.

Address: H. No. 205, third ward, Colva, Salcete, Goa — 403708.

Construction technique(s): Likely to be cob.

Visited on: 27/04/2017.

BUILDING DATA

CHRONOLOGICAL DATA

Construction date: About 150 years old, when Antonio's grandfather was alive.

Builder: Unknown.

Original use: Distillery ('*batti*' in Konkani).

Present use: Storage for firewood, coconuts, etc.

History of the building: Antonio's His grandfather was a toddy-tapper and used this building to make local alcohol. (Toddy is a sap extracted from coconut trees. It is used in cuisine, especially to make alcohol.)

Restorations and/or interventions: Laterite-and-cement pillars were built about 12 years ago to support and salvage the structure.

Building in use or not: Still in use.

Building at risk: Yes, it is in ruins.

Information given by: Owner.

Other important data:

Perspectives of the building



Earth used & Typology



TECHNICAL DATA

Base-course: In earth.

Flooring: Beaten-earth (no longer exists).

Buttresses: None.

Corners: In laterite-and-cement masonry (not original).

Openings: A door and a window on front facade. The building is in ruins, so the original number of openings cannot be determined.

Roof type: 'Mangalore-tiles' and metal-sheets. 85cm overhang on west side; approximately 36cm on north.

Thickness of exterior walls: 44cm.

Distinct architectural details:

Observations:

TYOLOGICAL DATA (rammed-earth / cob)

Description of earth used: Light-yellow, clay and sand. Presence of laterite and other rubble. Pieces of lime, shell and brick or fired-roof-tiles.

Dimensions of 'lifts': 'Lift' heights vary from one 'lift' to the other, and from one end of the same 'lift' to the other. Heights from wall-base to top: 57cm, 61cm, 49cm (east wall). 60cm, 59cm, 62cm, 44cm, 43cm (south wall).

Mortars:

Plasters, pigments and/or paints: No plaster on exterior and interior walls.

Distinct characteristics:

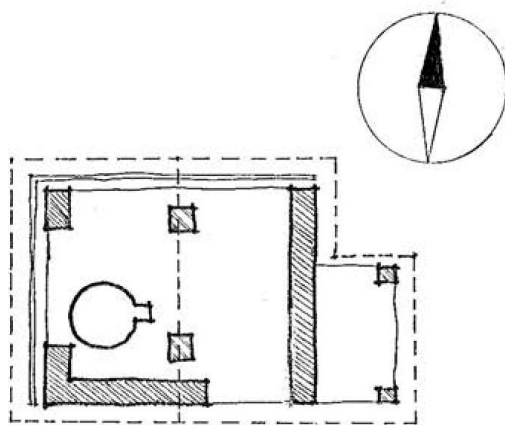

[Drawings by Lionel Afonso, 2018-2019]



Damages incurred / problems faced: Roof-frame is rotting.



Damages incurred / problems faced: Structural cracks.



Damages incurred / problems faced: Structural cracks.



Damages incurred / problems faced: Insects have built earthen-nests on wall.



→ Metal-sheets cover damaged parts of roof.

→ Tree branches support the roof.

→ Palm-leaf barriers built to protect walls.

Care and continuity: Temporary measures to salvage the structure include palm-leaf barriers to protect walls, tree branches to support the roof, metal-sheets cover damaged parts of roof.

CARE AND CONTINUITY

CONDITION ASSESSMENT

Damages incurred / problems faced:

Observations: Roof-frame is rotting and failing. Structural and non-structural cracks on walls, north wall seems to be tilting towards the inside, wall-bases eroded, mason-bee holes, insects have built earthen-nests on wall.

MAINTENANCE AND REPAIRS

Preventive conservation:

Periodic interventions:

Repairs: (Refer 'Restorations or/and interventions' section.)

Observations: Looks like attempts had been made to repair wall cracks with earth. Temporary measures to salvage the structure include palm-leaf barriers built to protect walls, tree branches used to support the roof, metal-sheets cover damaged parts of roof.

Other information:

Challenges faced today:

Future plans: No plans besides letting the building deteriorate in its own time.

SURVEY NO. 6

IDENTIFICATION

District: South Goa.

Taluka: Salcete.

Village: Colva.

Owner(s) / Tenant(s): Conny Rodrigues.

No. of inhabitants: Four, a family with two children. The father has recently moved abroad.

Address: H. No. 179, Tolloi, Colva, Salcete, Goa — 403708.

Construction technique(s): Cob.

Visited on: 30/05/2018.

BUILDING DATA

CHRONOLOGICAL DATA

Construction date: 1965.

Builder:

Original use: House.

Present use: House.

History of the building:

Restorations and/or interventions: The mud used to build this house was sourced from the hill close-by (mud from the hill is referred to as '*dongraoilli matti*' in Konkani). The original construction comprises the two big rooms that form the front part of the house. Before, the kitchen was on the right end corner of the big room (now used as a hall), and the window on the south wall was then a door. The veranda along the facade, and the room along the rear of the house were built in laterite masonry just a few years ago. The new rooms now serve as a kitchen, dining, storeroom, and also accommodates a bathroom.

Building in use or not: Still in use.

Building in use or not: No.

Information given by: Owner's wife and daughter, Abigale.

Other important data: This used to be the tallest house amongst all the houses in the locality. Now, there are double-storey houses, which are obviously taller. Curtains cover the interior walls in the hall.

Perspectives of the building



Earth used & Typology



TECHNICAL DATA

Base-course: Not visible.

Flooring: Flooring sheets in hall and veranda, cow-dung in bedroom and (new) kitchen, tiles in bathroom; cement in the shed behind the kitchen.

Buttresses: None.

Corners: Mainly in earth, there are some laterite-stones.

Openings: Two doors, three windows and vents.

Roof type: 'Mangalore-tiles' and metal-sheets. 67cm overhang on main facade; 1.12m over window on south facade.

Thickness of exterior walls: 45cm.

Distinct architectural details:

Observations: An additional layer of earth caps the roof-line. Looks like this was done after the roof was installed in order to secure the rafters to the wall.

TYPOLICAL DATA (rammed-earth / cob)

Description of earth used: Red with a lot of rubble.

Dimensions of 'lifts': 'Lift' height vary, even along the length of the same 'lift'. Heights from wall-base to top: 57cm, 52cm, 59cm (exterior north wall); 7cm of cow-dung wash, 40cm, 52cm, 50cm, 60cm, 52cm (interior north wall).

Mortars: In earth or lime, unclear. 5cm along vertical and horizontal joints on laterite window frames.

Plasters, pigments and/or paints: Most walls have no plaster. Lime or cement plaster on front facade, cement plaster on part of north facade (exterior). No plaster on most walls (interior). Laterite window frames, and some parts of the new extension are plastered with cement (exterior and interior).

Distinct characteristics:

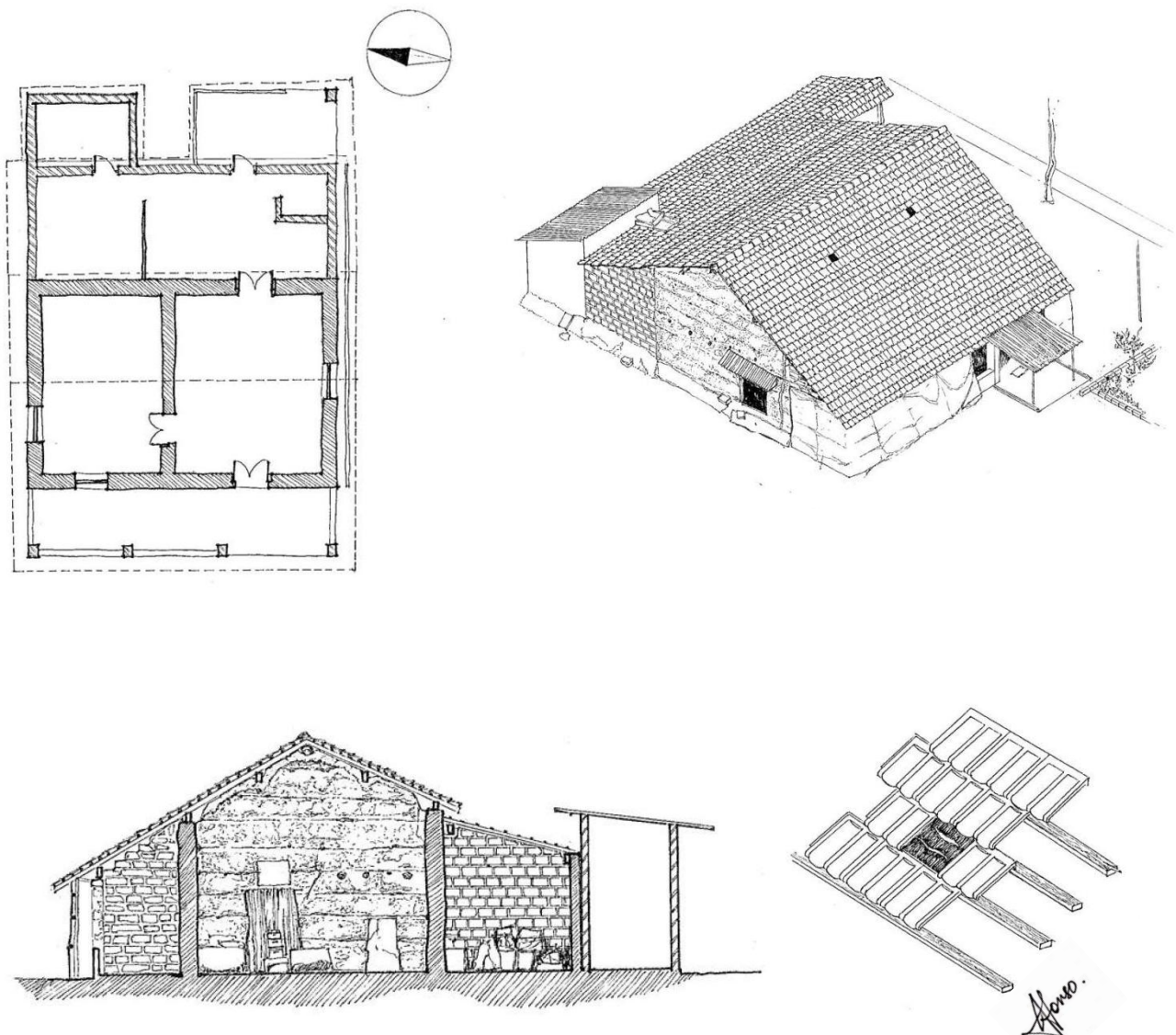

[Drawings by Lionel Afonso, 2018-2019]



Corners: Mainly in earth, there are some laterite-stones.



Observations: An additional layer of earth caps the roof-line. Looks like this was done after the roof was installed in order to secure the rafters to the wall.
(Also refer image in 'Typology' section.)



(South wall.)

Maintenance and repairs: The entire south facade is protected by a coconut-palm barrier to protect the wall from rainwater. The south wall is thus less eroded than the north.



(North wall.)



Damages incurred / problems faced: Cracks.



Maintenance and repairs: Overhangs over facade windows protect interiors from rainwater. The gradient and window along the north are covered with Tarpaulin.

CARE AND CONTINUITY

CONDITION ASSESSMENT

Damages incurred / problems faced: Cracks.

Observations:

MAINTENANCE AND REPAIRS

Preventive conservation:

Repairs: Cement used to repair cracks.

Observations: Metal-sheet overhangs over facade windows protect the interiors from the rainwater that enters with winds. The entire south facade is protected by a coconut-palm barrier to protect the wall from rainwater. The south wall is thus less eroded than the north. The gradient and window along the north are covered with tarpaulin. The veranda also has tarpaulin protection.

Other information:

Challenges faced today:

Future plans:

SURVEY NO. 7

IDENTIFICATION

District: South Goa.

Taluka: Salcete.

Village: Colva.

Owner(s) / Tenant(s): Fatima Maria Rodrigues e Fernandes, 64 years old.

No. of inhabitants: Four, a family with two sons. The father and the eldest son work abroad.

Address: H. No. 165, Vanelim, Tolloi, Colva, Salcete, Goa — 403708.

Construction technique(s): Cob.

Visited on: 30/04/2018.

BUILDING DATA

CHRONOLOGICAL DATA

Construction date: +100 years, during Fatima's grandfather's generation.

Builder: The house was built and repaired by workers who belong to the 'Gauda' tribe of Goa.

Original use: House + a room for storage of rice grains.

Present use: House + a room for storage of rice grains.

History of the building:

Restorations and/or interventions:

1. When Fatima's father was alive, he made many alterations to the house. He particularly liked having more windows, and the masons would create these in existing walls by using a pickaxe.

2. Before Fatima was born, the room that is now used as a storeroom was used as a kitchen. Fatima's father got this room modified and built a separate kitchen. He increased the height of the storeroom by raising the roof-line with laterite-masonry (external wall) and earth (interior wall).

3. Earlier during summers, villagers used to sleep in the balconies because it was cooler outdoors. Houses had no door and window shutters. People did not feel the need for these as they felt safe in their locality. Window grills were fixed in Fatima's house in 1962-63, after a theft.

4. Around the same time, the 'sopo' (traditional seats in the veranda) was converted into a balcony, and some walls were plastered with cement. Other walls were plastered with lime, and/or painted with a mixture of lime and indigo ('neel' in Konkani). The cow-dung floors in the balcony and hall were replaced with red-oxide. These renovations were made in preparation of Fatima's sister's wedding.

5. Fatima's son is specially-abled and has some breathing difficulties. The smell of fresh cow-dung and the dust these floors generate, pose problems to his health. So in 2010, Fatima covered the hall and bedroom floors with flooring-sheets.

6. Recently, some walls in the hall were plastered with lime. The brand name was 'Surya Cem Sparkling Limewash.' It was soaked for two hours, sieved and then applied.

Building in use or not: Still in use.

Building at risk:

Information given by: Owner.

Other important data: As from what Fatima knows, Remeth's house (Survey No. 8) was the last mud-house built in the locality. It was built before she was born.

Perspectives of the building



Earth used & Typology



TECHNICAL DATA

Base-course: Wider than the rest of the wall on front facade; construction material not visible.

Flooring: Cow-dung in storeroom, red-oxide in the veranda and kitchen, flooring-sheets in the hall and bedroom.

Buttresses: None.

Corners: Not visible as the house is plastered.

Openings: Two doors and seven windows.

Roof type: 'Mangalore-tiles' and metal-sheets. 1.2m overhang on front and north facades (includes metal-sheets); and 95cm on back facade.

Thickness of exterior walls: 46cm.

Distinct architectural details:

TYOLOGICAL DATA (rammed-earth / cob)

Description of earth used: Yellowish-brown, clayey and sandy. Few traces of rubble, shells, etc. Similar, but slightly more sandy soil used as mortars in laterite masonry.

Dimensions of 'lifts': 'Lift' heights vary from one 'lift' to the other, and from one part of the same 'lift' to the other. On the west wall of the storeroom, 'lift' heights included 30cm and 40cm.

Mortars: Not visible because of plaster.

Plasters, pigments and/or paints:

Exterior: Most walls are plastered with cement. The storeroom part is plastered with lime. The veranda is painted in a darker shade of blue (than the interior of the house). The walls and decorative elements of the veranda are bordered with bright blue oil-paint (brown coloured paint is visible under the layer of blue, where the oil-paint is chipped off; probably, the blue replaced the brown).

Interior: All rooms are plastered, except storeroom. The hall is plastered either with cement or lime. The bedroom still has the old lime-plaster from the 1960s. It is 0.1cm thick and largely comprises two layers: the lowermost and the thickest is lime, followed by a thin coat of lime + indigo which gives a light-blue colour. The thicker layer seems to consist of several thin layers. The wall that divides the bedroom and storeroom has a thin coat only, comprising lime + indigo. In the kitchen, the wall surfaces are yellow.

Distinct characteristics: Presence of laterite-stones in between 'lifts'.

Observations:

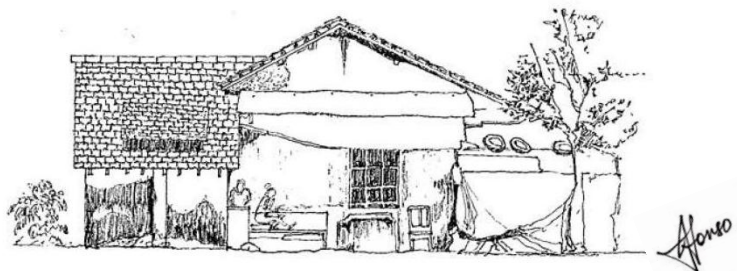
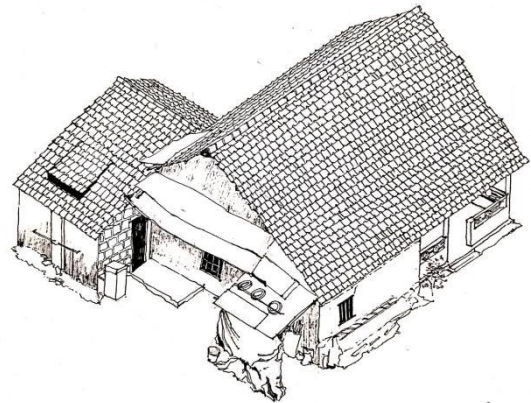
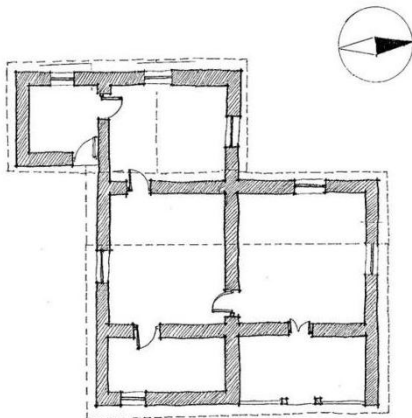

[Drawings by Lionel Afonso, 2018-2019]



Rear view.



Damages incurred / problems faced: Cracks, especially near lintels.



(Hall.)



(Bedroom.)

Damages incurred / problems faced: Cement was used on one side of the wall, and the crack on the other side started getting longer (common wall that separates hall and bedroom).



Damages incurred / problems faced: Honey-bees build earthen-nests on the wall surfaces, and store worms in them, especially during the monsoons.



Maintenance and repairs: Tarpaulins covers are usually mounted before the monsoons and removed after the monsoons.

CARE AND CONTINUITY

CONDITION ASSESSMENT

Damages incurred / problems faced:

Exterior:

1. Dampness, especially on north and rear walls.
2. On parts of the rear wall, the earth got disintegrated (*'pokod'* in Konkani).

Interior:

3. Cracks, especially near lintels. About two and a half years back, the kitchen window lintel was damaged by white ants, the wall began taking the weight of the roof and cracks developed, thus putting the wall at risk. So the window was filled-up and closed. One of the windows in the hall too has cracks around it, and the wall has become very delicate. The shutters of this window are no longer opened for fear that the opening and closing movements might bring down the wall. When repairing the roof, especially with the use of the hammer, such cracks get longer and wider, and mud falls-off from the walls.
4. About 3-4 years back, cement was used on a wall, and the crack on the other side of the same wall started getting longer (wall that separates hall and bedroom).
5. Too many cobwebs as spiders can enter there houses easily through the gap between the wall and the roof.
6. Once, the electric currents had gone off and a lit candle led to a fire in the hall; it burnt the whitewash.
7. Honey-bees bore holes in the earthen walls, and plaster fall-off. They also build earthen-nests on the wall surfaces, and store worms in them, especially during the monsoons. (Mud from these nests can be mixed with water or alcohol and applied; it cures headaches.)
8. When raw mangoes are stored on floors, the sap damages the flooring.

Exterior and interior:

9. Flaking and falling plasters.

Observations:

MAINTENANCE AND REPAIRS

Preventive conservation:

Periodic interventions:

1. The roof is usually repaired in the summer, before the monsoons. This was done recently. All the tiles were removed, cleaned with a stick-broom (*'iria san'* in Konkani), and rearranged. The roof-frame was repaired using a drill and nails. About 5-6 workers were employed; they finished the work within a day.
2. Tarpaulins cover the gradient along foot-walls, as well as the veranda and overhangs. These plastic covers are usually mounted before the monsoons and removed after the monsoons.
3. Red-oxide floors are repainted sometimes, in order to keep them from eroding completely. This is mainly done for aesthetic reasons, especially that the red colour reflects a shine.
4. Before, the cow-dung floors were given a fresh layer every three months. However, as redoing these floors affects Fatima's son's health, she reduced to it to once a year. Of recent, she has been trying to avoid it completely, and has not redone the floors in the last three years.
5. Cobwebs on ceilings have to be removed with a long broom every two months, otherwise dust begins to fall from the roof and upper walls.

Repairs: On the rear wall, the mud that was disintegrated was removed, the gaps were dugout a little deeper, and were refilled with cement.

Observations: Roofs extended with metal-sheets to provide additional protection from rainwater. There are roof-tiles and wood piled on the earthen-gradient along exterior walls, probably meant to protect lower walls from water ingress. Cement repairs, including re-pointing of earthen mortars.

Other information:

Challenges faced today: (Refer 'Periodic interventions' section.)

Future plans: To demolish and reconstruct.

SURVEY NO. 8

IDENTIFICATION

District: South Goa.

Taluka: Salcete.

Village: Colva.

Owner(s) / Tenant(s): Florence Ursula Dias (passed-way) and her children, Remeth and Menino Rodrigues.

No. of inhabitants: Two families.

Address: H. No. 164, Tollio, Colva, Salcete, Goa — 403708.

Construction technique(s): Cob.

Visited on: 30/04/2018.

BUILDING DATA

CHRONOLOGICAL DATA

Construction date: Unknown.

Builder: Remeth's and Menino's grandparents.

Original use: House.

Present use: House.

History of the building: Remeth's and Menino's grandparents used to live in another house next door. An oak tree fell on it and the house broke down. The house in which the family is now living in was built with mud brought from a nearby pond (mud from around a pond is called '*tolya matti*' in Konkani) in the fields. This pond is in front of Fatima's house (Survey No. 7).

Restorations and/or interventions: About 28 years ago, in preparation of a family wedding, cow-dung floors were replaced with red-oxide, the interior walls were whitewashed for the first time, and country tiles were replaced with 'Mangalore-tiles'. Before Egidia's wedding in 2003, the front facade was plastered with cement. Recently, a kitchen was constructed along the rear of the house, and a bedroom along the front facade. These new additions are built with laterite-and-cement. A metal overhang along the north facade serves as a cattle shed.

Building in use or not: Still in use.

Building at risk: No.

Information given by: Egidia Fernandes, Remeth's wife.

Other important data: Egidia agrees that earthen-houses are good. Considering that in the near future, there could be a shortage of laterite-stone in the market owing to environmental reasons, there is a possibility that people would restart building with earth.

Perspectives of the building



Earth used & Typology

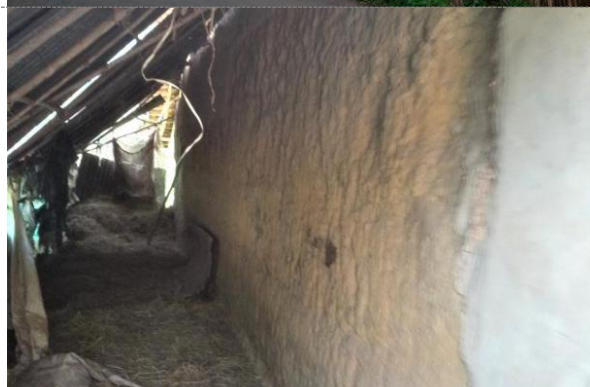

TECHNICAL DATA

Base-course: In earth.

Flooring: Red-oxide in veranda; cement in hall and bedroom; cow-dung in dining-room, bedroom and kitchen. There are designs on the hall floor.

Buttresses: None.

Corners: In earth.

Openings: Two doors and two windows.

Roof type: 'Mangalore-tiles'. 60cm overhang on north side.

Thickness of exterior walls: 42cm.

Distinct architectural details: Earthen-pillar inside the house.

Observations:

TYPOLOGICAL DATA (rammed-earth / cob)

Description of earth used: Yellowish, clayey and sandy. Presence of rubble, pebbles, roof-tile pieces, etc.

Similar, but slightly more sandy soil used as mortars.

Dimensions of 'lifts': 'Lift' heights are not uniform, and vary even along the same 'lift'. On the south facade, the two lowermost 'lifts' are covered with cement. Heights of the ones above differ along the width of the wall: 55cm, 58cm, 53cm on one part; 50cm, 54cm, 60cm in another part.

Mortars: 4cm thick along both, vertical and horizontal joints of laterite-stone framed window (south facade).

Plasters, pigments and/or paints: No plaster on most of south and north facades. Cement plaster on balcony and extended room, thus on entire front facade (exterior). Thin coat of lime on earthen walls (interior), including window jambs.

Distinct characteristics:

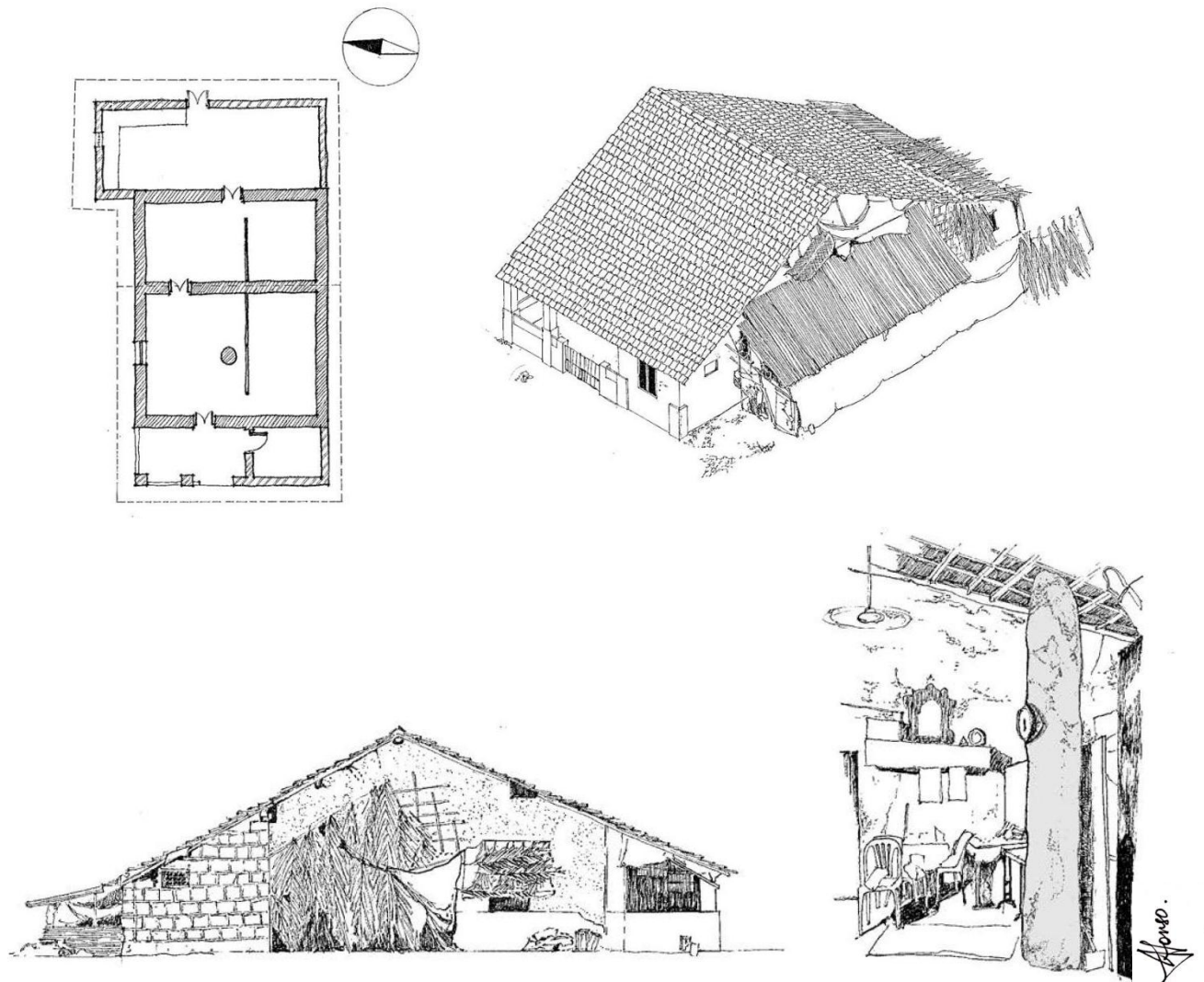

[Drawings by Lionel Afonso, 2018-2019]



Flooring: Cement in hall; there are designs on the hall floor.



Plasters: Thin coat of lime on earthen walls (interior).



Plasters: Thin coat of lime on earthen walls (interior), including window jambs.



Damages incurred / problems faced: Holes and chipping on flooring.



Damages incurred / problems faced: Rotting of lintels.



Maintenance and repairs: Every year before the monsoons, old palm-leaf overhangs are replaced with new ones.

CARE AND CONTINUITY

CONDITION ASSESSMENT

Damages incurred / problems faced:

An oak tree fell on their old earthen house and destroyed it. Dust gets collected in between roof-tiles, roof leakage. A few years ago, a crack appeared on the wall in the hall. The upper walls of the dining-room have blackened because of the smoke from the kitchen; hot air rises. Rats make holes at the base of walls.

Observations: Signs of water run-off on walls, visible on south-east exterior corner. Cracks, especially in corners. Rotting of wooden lintels. Holes in cow-dung floors, and chipping of cow-dung and cement floors.

MAINTENANCE AND REPAIRS

Preventive conservation:

Periodic interventions: The roof is cleaned and tiles are replaced every 2-3 years, if needed. Every year before the monsoons, walls are covered with tarpaulin, and old palm-leaf overhangs are replaced with new ones. Before the village feast, the house is painted and the interior walls are white-washed. (The lime is shell-based, bought from Miranda Hardware shop in the village.)

Repairs:

1. There was a big crack in the hall, and the owners were scared that the wall might fall. So they filled it up with cement about two years back, when painting the house before the village feast.
2. Cement was applied to the lower part of the south wall to protect it from the water that gets collected near that wall during the monsoons. The cement used was that what was left after plastering the main facade.
3. Holes made by rats are filled with cement. This was done about 15 years back, after Egidia's wedding and even today, holes are patched up as soon as possible. If they are left open, ants enter through them.

Observations:

Other information: Rafters made from older coconut trees last long. Those made from young coconut trees are prone to termite attack. (In Konkani, a coconut tree is called '*mhad*', a young coconut tree is called '*torne mhad*', an older coconut tree is '*zune mhad*', coconut tree rafters are called '*aché*', and termite attack is called '*adoi*'.) The red-oxide available in the market today loses its colour as well as shine quickly.

Challenges faced today: (Refer 'Damages incurred / problems faced' and 'Periodic interventions' sections.)

Future plans: Division of the property and house is pending, and hence very little investment is made in repairing the house. Once the property and house is divided between the two brothers, they will demolish and reconstruct the house.)

SURVEY NO. 9

IDENTIFICATION

District: South Goa.

Taluka: Salcete.

Village: Majorda.

Owner(s) / Tenant(s): Maria Xena Fernandes, 80 years old. (The ancestral owners, her mother-in-law passed away in 1971, and her husband in 2010.)

No. of inhabitants: One.

Address: H. No. 480, Curilo, Majorda, Salcete, Goa — 403713.

Construction technique(s): Cob.

Visited on: 30/04/2018.

BUILDING DATA

CHRONOLOGICAL DATA

Construction date: Construction started in 1949. They moved into the house on 20th March, 1950.

Builder: Labourers (*'manai'* in Konkani), owners helped.

Original use: House.

Present use: House.

History of the building: The bigger former house was demolished and the current one was constructed in its place. It took about a year to complete the new house; it depended on the availability of labour. When the house was being built, the family stayed at neighbours' or relatives' house. The road by the side of the house was built later.

The construction process: The foundation has a depth of '1 hath' ('hath' means 'hand' in Konkani) i.e. the distance from the tip of the finger to the elbow; the width was also '1 hath'. Five layers of laterite-stones were laid along the external side of the foundation wall, following which the it was left open throughout the monsoons so as to allow the laterite to season. (The opposite neighbours' house was built around the same time. They let the foundation soak for two monsoon seasons; the longer the exposure to water, the better is the quality of laterite.) Once the monsoons ended, the wooden frames for doors were installed, followed by laterite-masonry around these frames. It was only after these steps that building with earth began.

The earth for building was sourced from the previous house and a nearby field. The field is now buried and houses are built there instead. Mixing of the mud was done by workers. It took them one day to mix the mud. The first 'lift' (the first 'lift' is called 'teno,' 'tor,' or 'intuj' in Konkani) was '1 hath' in height. The 'lifts' were built in parts over a period of time, continuing all along the footprint of the house. By the time the 'lift' was complete, the part where it was started was already dry and ready to take the weight of the next 'lift' above it.

After the first 'lift' was ready, the door and window frames (*'casil'* in Konkani) were then laid, followed by the other 'lifts'.

For the floor, the earth that was dug out for the foundation of the house was used to fill-up the plinth. This was covered with a mix of laterite rubble (*'salo'* in Konkani) + mud. The floor was then rammed (the ramming action is referred to as *'petilé'* in past-tense in Konkani) with a ramming-tool, and finished with a layer of cow-dung.

Restorations and/or interventions:

1. A wall separating the bedroom and the storeroom was built with laterite-and-cement in 1969.
2. The wood-burning stoves (*'chul'* in Konkani) in the kitchen were replaced with a bathroom and basin.
3. There is a temporary palm-leaf extension on the rear of the house.

Building in use or not: Still in use.

Building in use or not: Yes.

Information given by: Owner.

Other important data: One of the workers who built the house was a neighbour, Jacku (passed-away). He was a Carpenter but helped with building as well.

Perspectives of the building



Earth used & Typology



TECHNICAL DATA

Base-course: About 40cm with a 4cm setback. In laterite-and-stone masonry.

Flooring: Cow-dung.

Buttresses: None.

Corners: In laterite-and-earth masonry on lower walls; earth on higher parts of the walls.

Openings: Two doors and five windows (one of the windows is blocked).

Roof type: 'Mangalore-tiles' and metal-sheets. 55cm overhang along front facade.

Thickness of exterior walls: 50cm.

Distinct architectural details: Decorative wooden pillars support the roof in the veranda.

Observations:

TYOLOGICAL DATA (rammed-earth / cob)

Description of earth used: Light-yellow, sandy. Very little rubble. Similar earth used in mortars.

Dimensions of 'lifts': 'Lifts' not visible.

Mortars: 3cm along vertical joints, and 3-6cm along horizontal joints along laterite-stone arched window (west facade).

Plasters, pigments and/or paints: No plaster, except front facade and west side base-course (exterior). No plaster, except kitchen and one wall in the hall are plastered with cement (interior).

Distinct characteristics: The exterior and interior walls have a uniform texture. There are pockmarks throughout, and no evidence of 'lifts'.

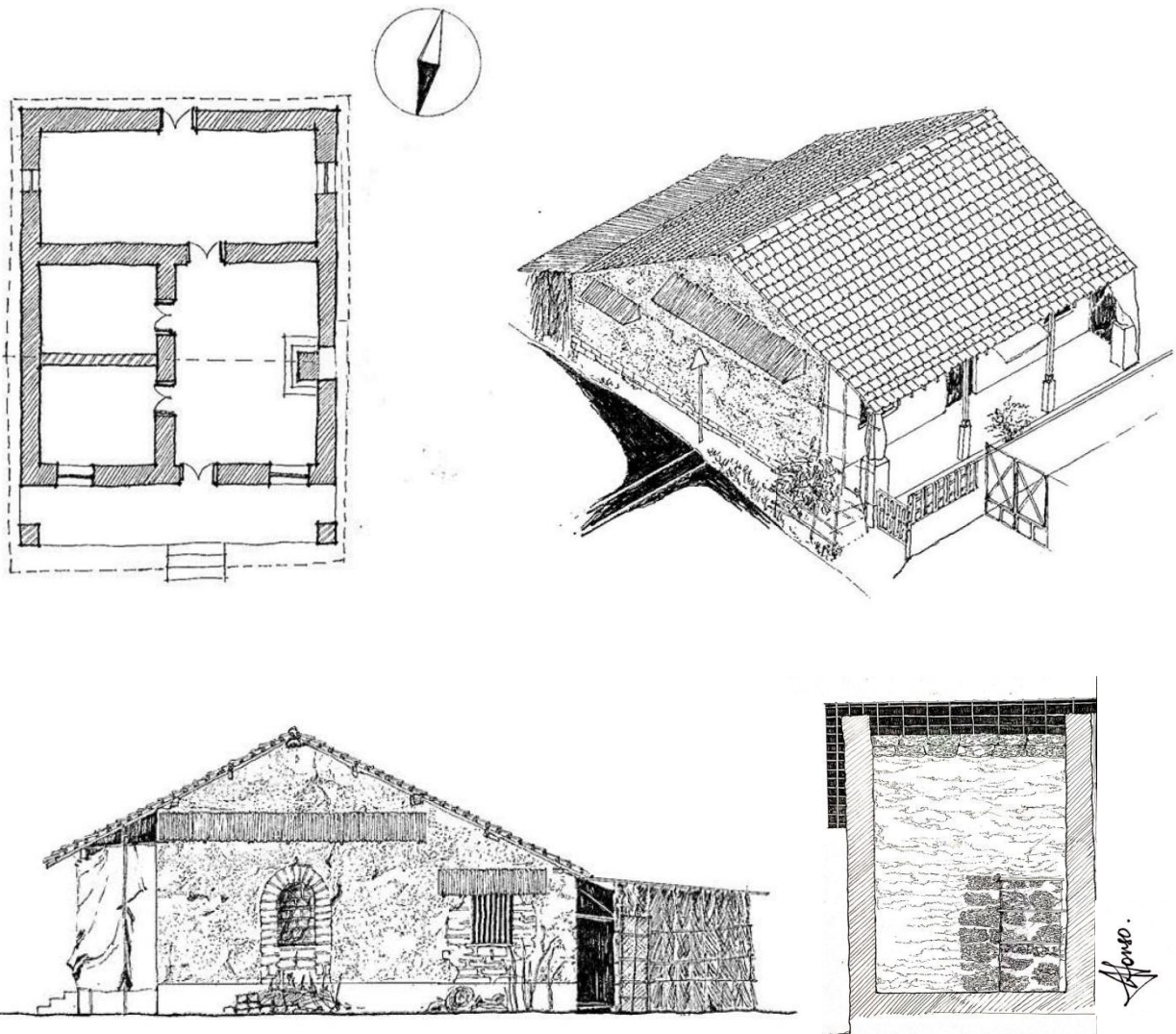

[Drawings by Lionel Afonso, 2018-2019]



Side view.



Distinct architectural details: Decorative wooden pillars support the roof in the veranda.



Corners: In laterite masonry on lower walls; earth on higher parts of the walls.



Plasters: No plaster, except kitchen and one wall in the hall are plastered with cement (interior).



Maintenance and repairs: A laterite block was built to cover the major crack and window opening, and thereby stabilise the wall. The block turned out to be more voluminous than needed.



Observations: Metal overhangs and tarpaulins protect walls from rainwater.

CARE AND CONTINUITY

CONDITION ASSESSMENT

Damages incurred / problems faced:

About 20 years ago, a storm led to many cracks on walls. One major crack around the window of the west wall destabilised the wall. Parrots make holes in the walls.

Observations: Flooring is chipped.

MAINTENANCE AND REPAIRS

Preventive conservation:

Periodic interventions: (Refer 'Challenges faced today' section.)

Repairs: The smaller cracks that appeared with the storm were repaired with 'menki mati' (type of mud), and the big ones were covered with cement. A laterite block was built to cover the major crack as well as the window opening on the west wall, and thereby stabilise it. The block turned out to be more voluminous than needed; it was a mason who went ahead with it and charged INR 15,000/-.

Cement repairs, including re-pointing.

Observations: Metal overhangs on east and west facades protect walls and interiors from rainwater spatter. Tarpaulin covers veranda, visible on west side.

Other information:

Challenges faced today: Earlier, Xena used to clean the roof more regularly, especially that there was a cotton tree nearby and the cotton would get stuck to the roof. It has been about eight years that the roof has not had its regular repair. Xena used to also apply a fresh layer of cow-dung every 2-3 months. Now, she does it only once a year. The last time the floor was redone was about 2 months back. In both cases i.e. of roof and floor repairs, it is difficult to find workers now a days.

Future plans: The house will be inherited by some relatives.

SURVEY NO. 10

IDENTIFICATION

District: South Goa.

Taluka: Salcete.

Village: Seraulim.

Owner(s) / Tenant(s): Caetano Remedios Fernandes.

No. of inhabitants:

Address: Shop No. 80, Near Our Lady of Pilar Church, Seraulim, 403708.

Construction technique(s):

Adobe-brick.

Visited on: 25/05/18.

BUILDING DATA

CHRONOLOGICAL DATA

Construction date: The earthen extension and oven were originally built in 1970. The oven was reconstructed in 1996.

Builder: The previous earthen-oven was built by masons hired by Caetano's father. It was broken-down and rebuilt by masons from Fatorda. Masons for the new oven were hired by Caetano and his mother, Rosa.

Original use: Shop. The earthen extension was built to house a bread-oven.

Present use: Shop cum bakery.

History of the building: The shop was leased out by the church, and the rear extension and oven ('forn' in Konkani) was built later. The shop is in laterite masonry; the extension in adobe-bricks, and the oven too was built with mud. The premise consisted of three parts. Rosa lived in the front room, the space in the middle was used for making the bread, and the third part i.e. the earthen extension housed the oven.

Reconstruction of oven: In the 1980s, the Konkan Railway line was built, and a railway track was laid just 8m away from the bakery. The vibrations created by moving trains led to cracks in the earthen-oven. In about 1996, a new oven was built using laterite-stone, cement and mud. 'Dhongraoili matti' (mountain soil, red in colour) was bought, and 'corse matti' (type of mud), which is easily available as surface soil in Goa was used in the building of the new oven. During this reconstruction, the rear adobe-brick wall of the bakery was torn-down and a laterite-and-cement was built in its place.

Construction process of the new oven: The circumference of the oven, upto the threshold of the door was built using laterite-stones and cement mortars. On the inside, most part of it was filled with mud. The mud was covered with a bed of iron pieces ('lokoni' in Konkani) collected from old cars, etc., followed by a 2.5cm thick layer of local sea-salt. Finally, these layers were sealed by placing square shaped baked-earth tiles over the salt; no grouting. The upper wall of the oven was constructed using laterite-stones and earthen-mortar, and the dome was entirely built with 'menki matti' (type of mud). A vent is left on the top, at the centre of the dome. When baking the bread, an earthen pot is placed upside-down over the opening on the top; the pot is sealed with ash from the oven.

The bakery was managed by the Fernandes family, mainly by Caetano's mother, Rosa. She was dedicated to the bread-making and insisted on living in the bakehouse premises till she passed-away in 2017. The family continued to operated the bakery on a part-time basis for a few months, and finally shut operations in the same year.

Restorations and/or interventions: (Refer 'History of the building', 'Reconstruction of oven' section.) In addition, there are temporary extension constructed along the north facade and rear of the building. These are built with coconut-fronds, tarpaulin and metal-sheets.

Building in use or not: The bakery is not in operation since 2017.

Building at risk: No.

Information given by: Caetano Remedios Fernandes and his wife, Fatima Fernandes.

Other important data:

Perspectives of the building



Earth used & Typology



TECHNICAL DATA

Base-course: In laterite-and-earth masonry.

Flooring: Cement.

Buttresses: No.

Corners:

Openings: Two doors and four windows (two doors and one window in the room built with earth).

Roof type: 'Mangalore-tiles'.

Thickness of exterior walls: 26cm.

Distinct architectural details:

Observations: There is a stepped decline on the top of the earthen walls.

TYOLOGICAL DATA (rammed-earth / cob)

Description of earth used: Yellowish, sandy. Presence of rubble.

Dimensions of 'lifts':

Mortars: In earth; 2cm along vertical joints, and 2.5cm along horizontal joints of adobe-brick masonry.

Plasters, pigments and/or paints: The facade of the earthen-walls have a lime plaster coated with yellow; 0.4-0.5cm thick in total (exterior). All walls are plastered, except the reconstructed laterite wall on the rear (interior).

Distinct characteristics: The structure is built with adobe-bricks. Approximate size: 43cm (length) x 19cm (height).

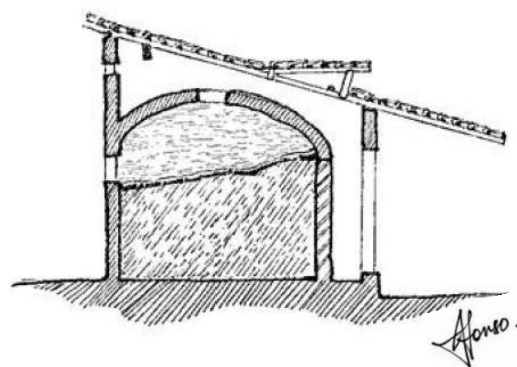
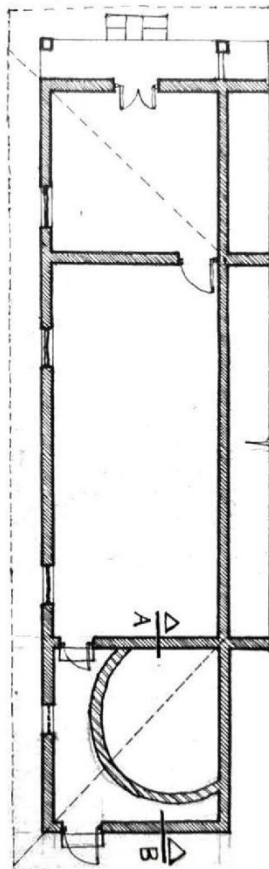
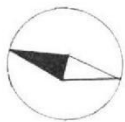

[Drawings by Lionel Afonso, 2018-2019]



Front and north facade. The shop is in laterite masonry, and the extension in adobe-bricks.



North facade, adobe-brick extension. Observations: Stepped decline on the wall top. Damages: Cracks demarcating the original, earthen-walls and the new, laterite-walls.



Restorations and/or interventions: The rear adobe-brick wall was torn-down and a laterite-and-cement was built in its place.
Damages incurred: Walls have blackened due to the smoke from the oven.



Damages incurred / problems faced: Flaking and falling plasters.

CARE AND CONTINUITY

CONDITION ASSESSMENT

Damages incurred / problems faced: (Refer 'History of the building', 'Reconstruction of oven' section.) In addition, a stone from the upper wall of the oven once fell-off.

Observations: Cracks demarcating the original, earthen-walls and the new, laterite-stone walls. Flaking and falling plasters. Walls have blackened due to the smoke from the oven.

MAINTENANCE AND REPAIRS

Preventive conservation:

Periodic interventions: No.

Observations:

Other information:

Repairs:

Old oven: When cracks developed, they were filled-up with 'menki matti' (type of mud). The mud was soaked for about two days in a vessel and then applied to the cracks. Masons were hired for the same.

New oven: When the stone fell-off from the upper wall of the oven, masons were hired to fix it. The repair costed about INR 10,000/-.

Challenges faced today:

Future plans:

SURVEY NO. 11

IDENTIFICATION

District: South Goa.

Taluka: Salcete.

Village: Majorda.

Owner(s) / Tenant(s): Piedade Gomes.

No. of inhabitants: One.

Address: H. No. 533, Curilo, Majorda, Salcete, Goa — 403713.

Construction technique(s): Likely to be cob.

Visited on: 24/05/2018.

BUILDING DATA

CHRONOLOGICAL DATA

Construction date: 1967.

Builder: Workers hired by Piedade and her husband.

Original use: House.

Present use: House.

History of the building:

Restorations and/or interventions: Originally, the building had no plaster. The cement plaster was put in about 1978. The veranda was built with laterite-and-cement about 10-12 years back.

Building in use or not: Still in use.

Building at risk: No.

Information given by: Piedade's daughter.

Other important data: Access to the inside of this house was not possible.

Perspectives of the building



Earth used & Typology



TECHNICAL DATA

Base-course: 32cm on east wall. 4-5cm setback on north and south walls. In laterite-and-earth masonry.

Flooring:

Buttresses: None.

Corners: In earth and laterite-stones.

Openings: Two doors, and windows and vents.

Roof type: 'Mangalore-tiles'.

Thickness of exterior walls: 45cm.

Distinct architectural details: Decorative laterite masonry base-course on front facade.

Observations:

TYPOLGICAL DATA (rammed-earth / cob)

Description of earth used: Deep red in colour, clayey. Lots of laterite rubble.

Dimensions of 'lifts': 'Lift' heights vary from one 'lift' to the other, and from one part of the 'lift' to the other. Heights from wall-base to top: 43cm, 46cm, 41cm, 59cm, 54cm (east facade). 47cm, 47cm, 43cm, 53cm, 41cm (another part of the same east facade).

Mortars:

Plasters, pigments and/or paints: Cement plaster on front facades, and parts of north and south facade (exterior).

Distinct characteristics: Some holes on walls are well defined (suggesting cob construction with shutters?). Two, finer 'lifts' constitute the gable (other surveyed structures displayed a single 'lift' in the gable or 'lifts' with more height. Refer images in Survey nos. 1, 2, 6, 7).

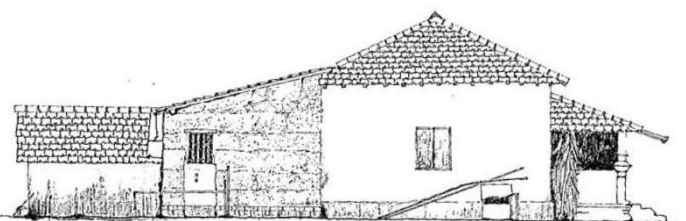
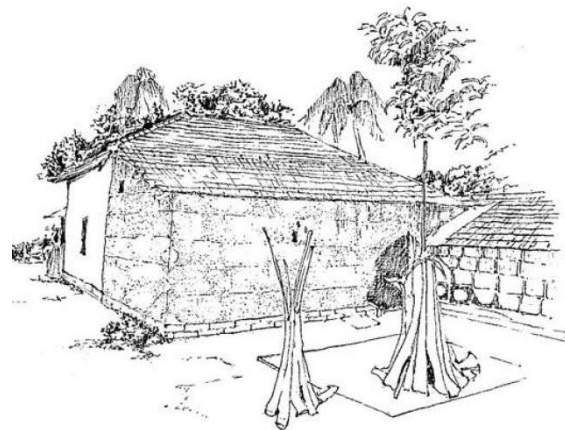
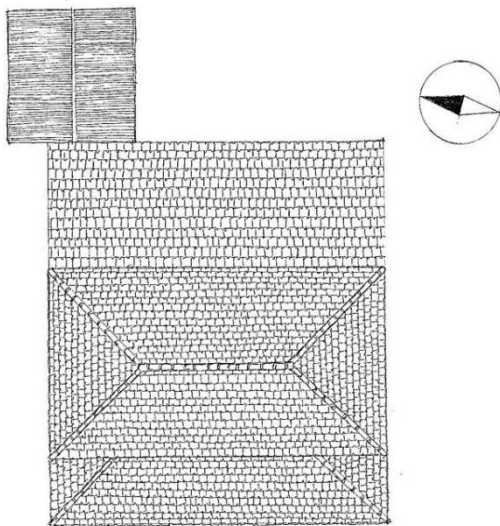

[Drawings by Lionel Afonso, 2018-2019]

Afonso.



Distinct architectural details: Decorative laterite masonry base-course on front facade.
 Maintenance and repairs: Taraulins, coconut palms and woven coconut-palms protect the veranda from rainwater.



Distinct characteristics: Some holes on walls are well defined (suggesting cob construction with shutters?).



Distinct characteristics: Two, finer 'lifts' constitute the gable (other surveyed structures displayed a single 'lift' in the gable or 'lifts' with more height. Refer images in Survey nos. 1, 2, 6, 7).



Damages incurred / problems faced: Black dampness blotch on rear wall.

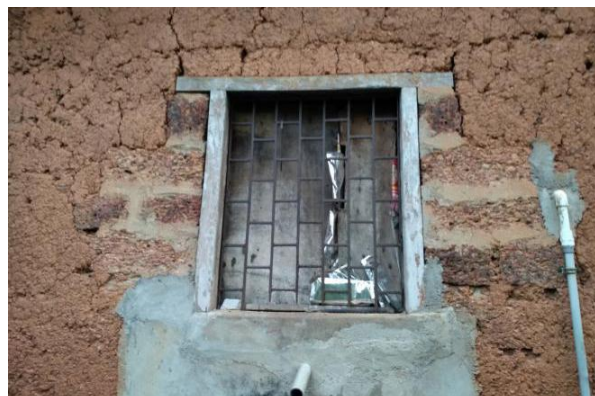

Maintenance and repairs: Cement repairs.

CARE AND CONTINUITY

CONDITION ASSESSMENT

Damages incurred / problems faced: Cracks appeared a few years back because the house is old and also because of the weight of the roof.

Observations: Some roof-tiles missing along overhangs, evidence of termite attack on rafters, small holes in walls, black dampness blotch on rear wall.

MAINTENANCE AND REPAIRS

Preventive conservation:

Periodic interventions: Every year, before the rains, the roof has to be retouched. Before, Piedade used apply a fresh layer of cow-dung on the floor every 2-3 months.

Repairs: Cement used to fill cracks, for re-pointing, and other repairs.

Observations: Tarpaulins, coconut palms and woven coconut-palms protect the veranda from rainwater. Roof overhang is extended with a metal-sheet to cover the steps at the entrance. The metal-sheet is folded along the rim. This is probably to direct rainwater towards the sides, thus clearing the path to the entrance of the house.

Other information:

Challenges faced today: As of now, nothing is being done to maintain the house.

Future plans:

SURVEY NO. 12

**Salgini village in Sanguem 'taluka' is a forest settlement situated in the hills of the Western Ghats, a UNESCO World Heritage Site. All the houses in the village are built with earth, except one which is in laterite-and-cement masonry.*

IDENTIFICATION

District: South Goa.

Taluka: Sanguem.

Village: Salgini.

Owner(s) / Tenant(s): Govind Ram Gaokar and Krishna Ram Gaokar.

No. of inhabitants: Two families. One of the families lives in another part of Goa, and visit during festivals.

Address: H. No. 115, Salgini, Sanguem, Goa.

Construction technique(s): Rammed-earth (referred to as 'taip' in Konkani.)

Visited on: 26/05/2018.

BUILDING DATA

CHRONOLOGICAL DATA

Construction date: In about 1988.

Builder: Owners along with neighbours.

Original use: House + agricultural purposes.

Present use: House + agricultural purposes.

History of the building: The soil for building this house was taken from the foot of the hill right next to the house.

Restorations and/or interventions: About 10 years after building the house, the veranda and two additional rooms were built with laterite-and-cement. When doing the flooring for the new room, the earthen-gradient along the foot of the north wall was covered with a cow-dung layer. Around the same time, a wall that divided the hall was also torn-down in order to create a more spacious one.

Building in use or not: Still in use.

Building at risk: No.

Information given by: Govind Ram Gaokar, owner; and Vital Gaokar, one of the neighbour who helped with building the house.

Other important data: Rice grains are stocked in the house. The last earthen-structure in the locality was built about 4-5 years back (it is the house in Survey No. 13). (Paper buntings hung in the hall for the 'Ganesh Chaturthi' festival are left on throughout the year.)

Perspectives of the building



Earth used & Typology



TECHNICAL DATA

Base-course: In earth. Height varies as the house is on a slope.

Flooring: Cow-dung.

Buttresses: None.

Corners: In earth.

Openings: Four doors and six windows.

Roof type: 'Mangalore-tiles'.

Thickness of exterior walls: 40cm.

Distinct architectural details:

Observations:

TYPOLICAL DATA (rammed-earth / cob)

Description of earth used: Brownish-red in colour, more clayey than sandy. Mainly laterite rubble present.

Dimensions of 'lifts': 'Lift' sizes cannot be determined as the house is plastered.

Mortars:

Plasters, pigments and/or paints:

Exterior: South and rear facades have a single coat of lime (faded in some parts). The front and north facade have a coat of blue paint. Window borders are highlighted on south facade.

Interior: 'Menki matti' is covered with lime, followed by a coat of cow-dung or paint. The upper and lower walls are covered with paint and cow-dung respectively, or in two different colours, so as to create a design.

Distinct characteristics: Laterite-stones were used in the construction at random; cannot be seen as walls are plastered.

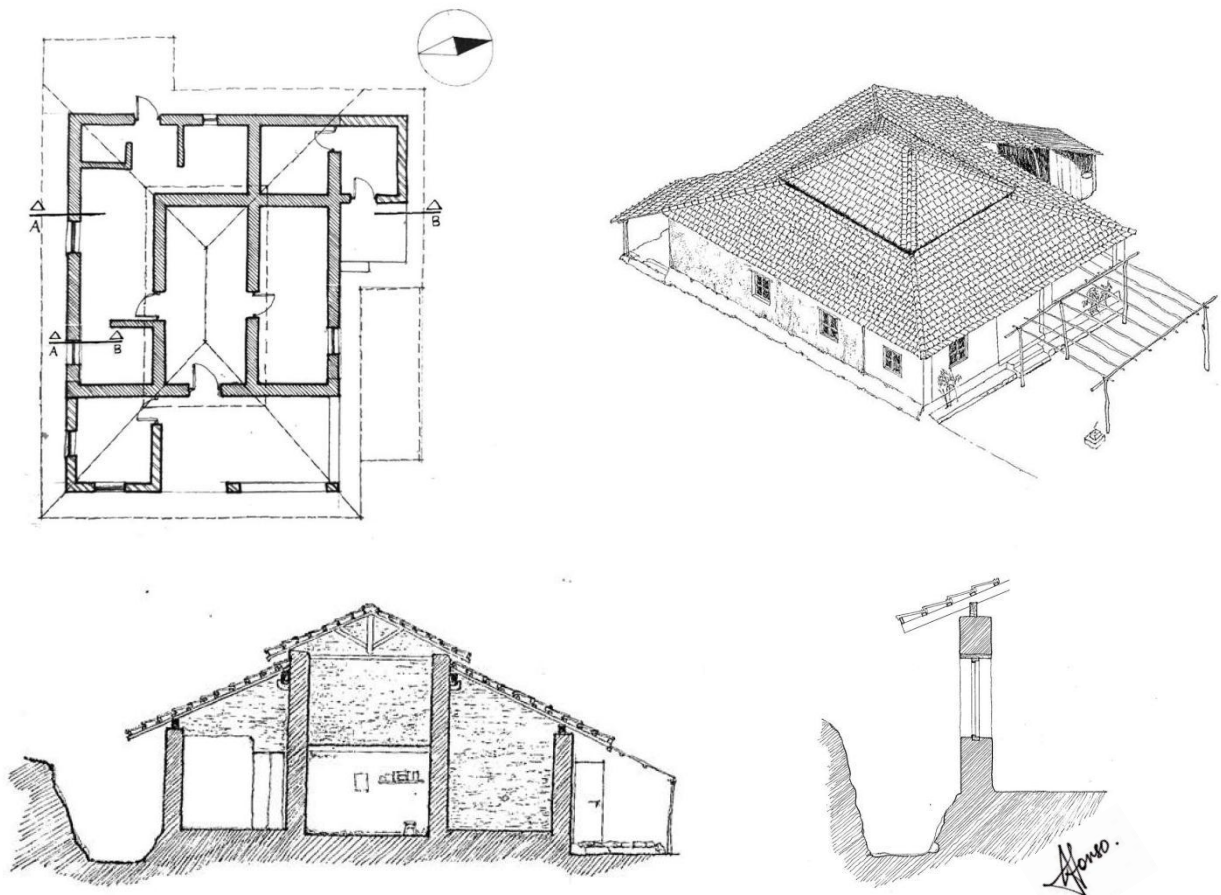

[Drawings by Lionel Afonso, 2018-2019]



Pathway to the house in the hills of the Western Ghats.



Side view.



Interior view.



Damages incurred / problems faced: Rats holes. Rats come into the house to eat the rice grains stocked inside.



Damages incurred / problems faced: Insects called 'bateen' make nests out of mud on roofs.



Maintenance and repairs: Cooking indoors on traditional wood-burning stoves gives out smoke; the heat and dryness makes the wood in the roof stronger, and keeps termites at bay.

CARE AND CONTINUITY

CONDITION ASSESSMENT

Damages incurred / problems faced: Insects called 'bateen' make nests out of mud on roofs. Rats holes; rats come into the house to eat the rice grains stocked inside.

Observations: Cracks and dampness blotches on walls, chipping of wall corners, blackened kitchen walls.

MAINTENANCE AND REPAIRS

Preventive conservation:

1. Before building the roof, the wood used in the framework is soaked for 10-15 days in clayey, water laden soil (this kind of soil is called '*chikon*' in Konkani). In the long run, this helps prevent white ants from infesting the roof frame.
2. Cooking indoors on traditional wood-burning stoves gives out smoke; the heat and dryness makes the wood in the roof stronger, and also keeps termites at bay.
3. During the monsoons, when the villagers sit by the fire to keep themselves warm, they put a blanket in between the roof framework. They say that the roof lasts longer this way.
4. Beetle-nut tree trunks are slit ('*kami*' in Konkani) and used in roof framework, but these are not of good quality. They give way in about 5-6 years, especially if not exposed to smoke.

Periodic interventions:

1. Before the monsoons, panels are made using bamboo on two sides and hay in between; these are fastened with wire. On the arrival of monsoons, it is decided which part of the roof needs this protection the most, and the panels are placed accordingly. These temporary panels protect roof-tiles from falling and breaking, and prevent leakage.
2. Every year after the monsoons, the courtyards and earthen gradients along wall-bases have to be redone. The soil, especially in the courtyard is loosened using a pickaxe, and re-rammed. It is finished with a layer of cow-dung.
3. The house is painted once a year before the 'Ganesh Chaturthi' festival.

Repairs: Rat holes are closed-up using 'menki matti' (a type of mud).

Observations: Metal-sheets are placed along the bases of the rear wall, probably as protection from rainwater.

Other information:

Challenges faced today: Before, there used to be many people in the house and food was cooked indoors on wood-burning-stoves. As mining activities in the region stopped about 20 years ago and villagers left for other places to look for jobs, there are very few people in the house and now, cooking is done outdoors. The wood in the roof is no longer exposed to smoke and heat, and it degrades sooner than it used to before.

Future plans:

SURVEY NO. 13

**Salgini village in Sanguem 'taluka' is a forest settlement situated in the hills of the Western Ghats, a UNESCO World Heritage Site. All the houses in the village are built with earth, except one which is in laterite-and-cement masonry.*

IDENTIFICATION

District: South Goa.

Taluka: Sanguem.

Village: Salgini.

Owner(s) / Tenant(s): Babi Ganesh Gaokar.

No. of inhabitants: One family.

Address: H. No. 161, Salgini, Sanguem, Goa.

Construction technique(s):

Rammed-earth i.e. 'taip'.

Visited on: 26/05/2018.

BUILDING DATA

CHRONOLOGICAL DATA

Construction date: (Refer 'History of the building' section.)

Builder: Owners along with neighbours

Original use: House.

Present use: House.

History of the building: The rammed-earth technique was chosen for building this house because it is less time consuming. The soil for building this house was taken from the foot of the hill right next to the house. Part of the house was built 20-30 years ago. The children later made modifications as per their choice, which included an addition of a rammed-earth room. There is also a laterite masonry extension in the rear. The house was plastered with lime made from shells ('shimpya chunno' in Konkani) bought from Sanvordem. Workers were hired to do the same. The construction was complete in 2014. About 1-2 years back, Babi's son re-plastered the walls with shell based lime, also bought from Sanvordem.

Restorations and/or interventions: (Refer 'History of the building' section.)

Building in use or not: Still in use.

Building at risk: No.

Information given by: Owner.

Other important data: The villagers said that before, houses were 'hand-moulded', indicating cob buildings. Rammed-earth (they used the term 'taip') came later. They explained that cob walls tend to bulge during construction, which can be corrected by trimming and beating the 'lifts'. In case of rammed-earth, the soil tends to break loose and fall-off from already constructed walls.

The only laterite-and-cement house in the village is that of Ravidas. It was built about 3 years back.

Perspectives of the building



Earth used & Typology



TECHNICAL DATA

Base-course: In earth.

Flooring: Cow-dung.

Buttresses: None.

Corners: In earth.

Openings: Three doors and no windows.

Roof type: 'Mangalore-tiles'.

Thickness of exterior walls: 32cm.

Distinct architectural details: The house is built on a hill slope. The lower slope is cut into various levels that lead to the house. Starting from the foot of the hill, steps are cut into the slope and lead to the courtyard, which is flattened. Another step forms a 'sopo' (in-built masonry seats in the veranda or porch), and a higher step forms the base-course and setback of the house. (The ground that forms these steps are thus natural, rather than levels built on an existing flat ground surface.) The setback is very wide. The house has no windows.

Observations:

TYPOLICAL DATA (rammed-earth / cob)

Description of earth used: Yellow-brown-red in colour, more clayey than sandy. Lots of laterite rubble present.

Dimensions of 'lifts': Cannot be determined.

Mortars:

Plasters, pigments and/or paints: 0.1-0.2cm of plaster, including paint. Rear facades not plastered (exterior and interior).

Distinct characteristics: The walls have a plain surface with many fine cracks, 'lifts' not visible.

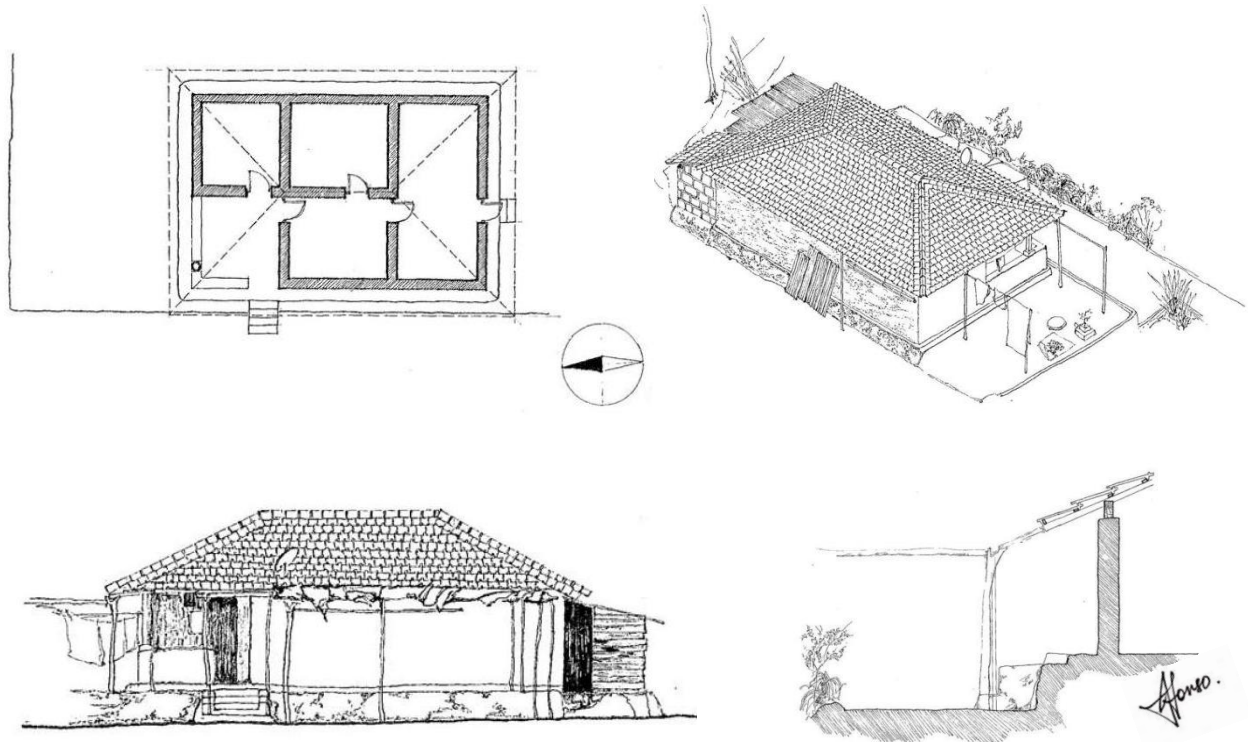

[Drawings by Lionel Afonso, 2018-2019]



(Hall.)



(Bedroom.)

Interior views.

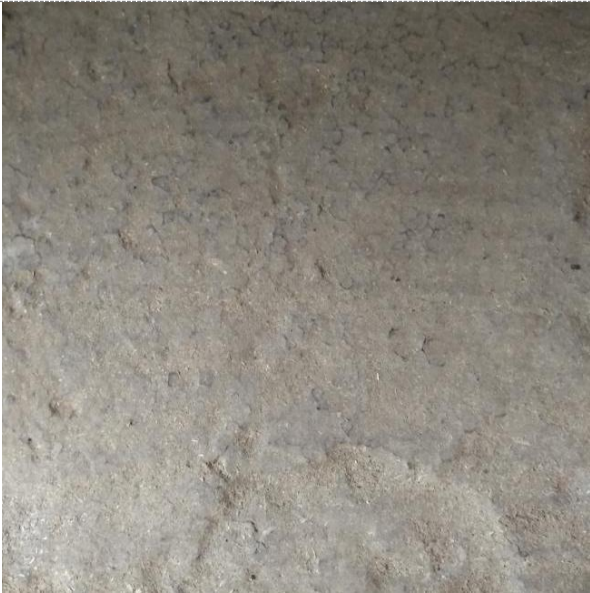

Flooring: Cow-dung.



Damages incurred / problems faced: A crack appeared just after the construction was complete.



Damages incurred / problems faced: Bulging of wall.



Damages incurred / problems faced: Chipping of wall edges.

CARE AND CONTINUITY

CONDITION ASSESSMENT

Damages incurred / problems faced:
A crack appeared just after the construction was complete.

Observations: Bulging of wall, chipping of wall corners, plasters and flooring.

MAINTENANCE AND REPAIRS

Preventive conservation:

Periodic interventions: During the monsoons, tarpaulin is put to protect the house from winds. A fresh layer of cow-dung is applied every eight days. (During the rainy season, cow-dung re-layering is not done for outdoors surfaces, such as the courtyard.) The house is painted every year before the 'Ganesh Chaturthi' festival.

Repairs:

Observations:

Other information: Before, coconut-palm coverings were used instead of tarpaulin.

Challenges faced today:

Future plans: To reconstruct in laterite-and-cement in four years time.

SURVEY NO. 14

**Goa's best known masons hailed from Pernem 'taluka'. However, when visited Oxelbag area in Dhargalim VP village, where at least one mason resided in every house, only one remaining earthen house was found. Most others were demolished and reconstructed in laterite-and-cement masonry. Though this structure had all its walls plastered and thus did not meet the selection criteria for this study, it was included because of the significance of its location.*

IDENTIFICATION

District: North Goa.

Taluka: Pernem.

Village: Dhargalim.

Owner(s) / Tenant(s): Carmelina Norhona.

No. of inhabitants: Five i.e. the owner, her two children and their spouses. All of them live in Mumbai and visit the house on vacation.

Address: H. No. 355, Oxelbag, Dhargalim VP, Pernem, Goa — 403573.

Construction technique(s): Claimed to be rammed-earth i.e. 'taip' by the owners.

Visited on: 27/05/2018.

BUILDING DATA

CHRONOLOGICAL DATA

Construction date: 1952.

Builder: Masons.

Original use: House.

Present use: House.

History of the building: This is the third generation of the family that is living in the house.

Restorations and/or interventions: A room was built along the rear about 15 years ago. Earth used for building the floor of this room was sourced from behind the house.

Building in use or not: Still in use.

Building at risk: No.

Information given by: Philip Norhona, Carmelina's son; and Churchill De Costa, her son-in-law.

Other important data:

Perspectives of the building



Earth used & typology cannot be seen as the whole structure is plastered.

TECHNICAL DATA

Base-course: In laterite-and-earth masonry. 2cm setback on north facade. Height varies as the house is on a slope.

Flooring: Red-oxide in veranda and bedroom. Cow-dung in hall, storeroom, kitchen and extension.

Buttresses: None.

Corners: Cannot be determined because house is plastered and painted.

Openings: Two doors and three windows.

Roof type: 'Mangalore-tiles'.

Thickness of exterior walls: 47cm.

Distinct architectural details:

Observations:

TYOLOGICAL DATA (rammed-earth / cob)

Description of earth used: Red coloured soil with lots of laterite rubble. Similar, but slightly sandy soil used in mortars on the base-course.

Dimensions of 'lifts': Cannot be determined because the house is plastered and painted.

Mortars: In earth; 1cm along vertical joints along laterite masonry base-course.

Plasters, pigments and/or paints: All external wall plastered and painted, except the extension (exterior). Lime-plaster and paint in the hall and bedroom; cement and paint in the kitchen and extension; cement in the storeroom (interior). There is a brownish-orange oil-paint bordering the wall-base and entrance door (exterior and interior).

Distinct characteristics: There is a compound wall built with laterite-stones and earthen-mortars. The laterite is of random shapes and sizes; mortars vary from 0-6cm along vertical joints, and 2.5-4cm along horizontal joints.

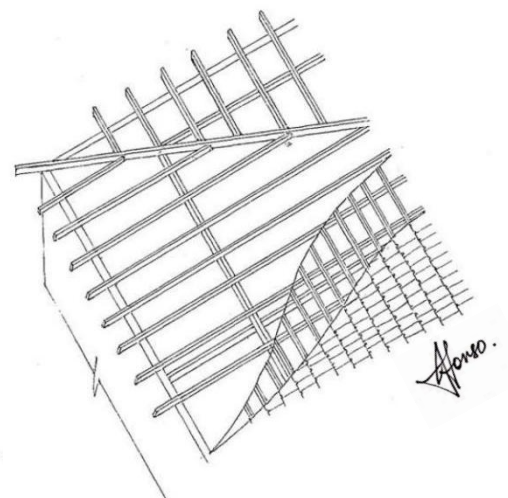
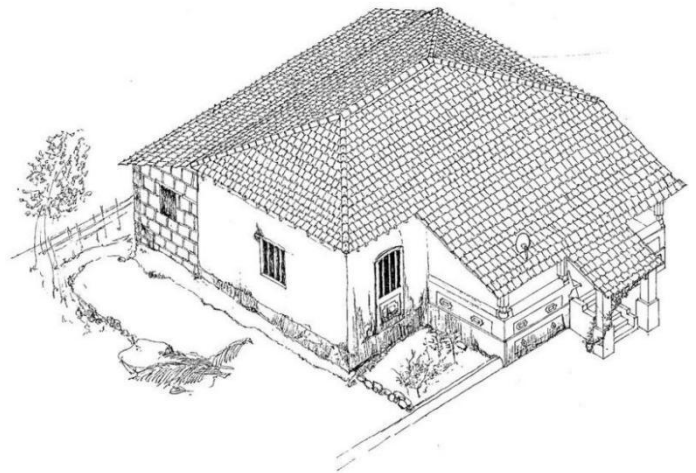
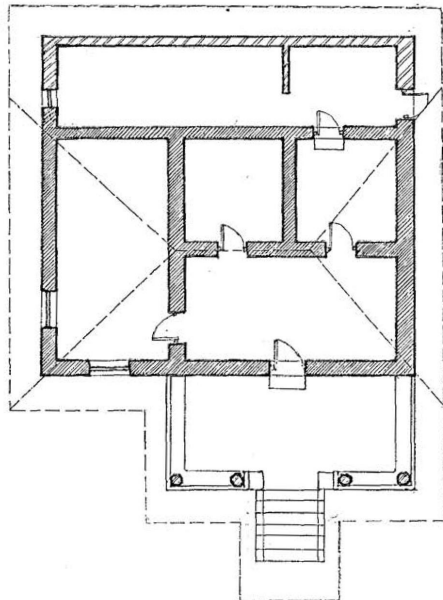

[Drawings by Lionel Afonso, 2018-2019]



Front porch.



Distinct characteristics: Compound wall built with laterite-stones and earthen-mortars.



Damages incurred / problems faced: Cracks on the bedroom wall because of the weight of the roof.

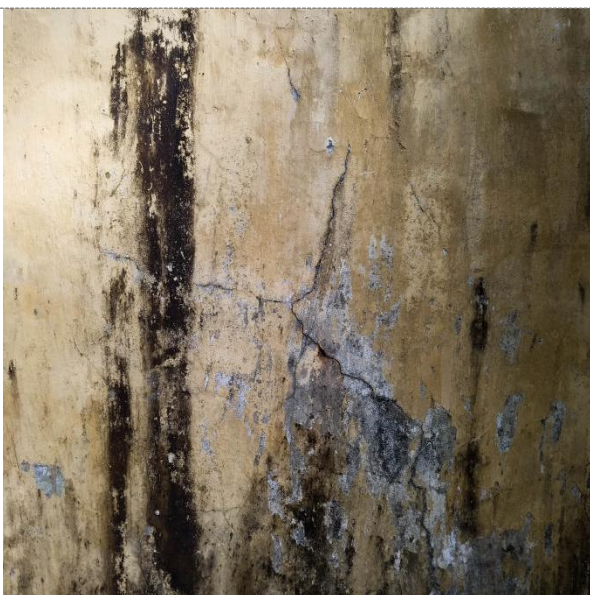

Damages incurred / problems faced: Cracks and dampness



Maintenance and repairs: A make-shift overhang covers the window on the front facade.

CARE AND CONTINUITY

CONDITION ASSESSMENT

Damages incurred / problems faced:

A crack appeared on the front facade about two years back, and more recently, on the bedroom wall because of the weight of the roof. The cracks got wider over time.

Observations: Some wooden rafters affected by termites, cracks on walls, falling and flaking plasters, chipped flooring, dampness on wall bases.

MAINTENANCE AND REPAIRS

Preventive conservation:

Periodic interventions: In the month of May, when the family visits the house on vacation, they replace broken roof-tiles; Carmelina usually takes charge of roof repairs. The cow-dung flooring is re-layered once a year.

Repairs:

Observations: A make-shift overhang covers the window on the front facade.

Other information:

Challenges faced today: Monkeys come and break tiles.

Future plans: Demolition and reconstruction with laterite and cement.

SURVEY NO. 15

IDENTIFICATION

District: South Goa.

Taluka: Sanguem.

Village: Neturlim.

No. of inhabitants: Six. Ms. Tanshekar, her son, daughter-in-law, and two granddaughters.

Owner(s) / Tenant(s): Tanshekar family.

Address: Tanshekar Spice Farm, Tali waddo, Neturlim, 403704.

Construction technique(s): Seems like Cob. Owners refer to it as 'taip' i.e. rammed-earth.

Visited on: 11/12/2018 and 21/12/2019.

BUILDING DATA

CHRONOLOGICAL DATA

Construction date: 250 years old.

Builder: Unknown.

Original use: House and agricultural purposes.

Present use: House, and agricultural and tourism purposes.

History of the building: This is the Tanshekar family's ancestral house. Years ago, it was inhabited by their big, joint family. The families were later separated because the Tanshekars owned vast lands, and each nuclear family was allotted a part to take care of. Today, the families live in their respective properties, and gather in this house during festivals. Currently, the fourth, fifth and sixth generation of the family lives in the house. The property has a spice farm. About 8 years back, earthen cottages were built on the farm for tourism purpose.

Restorations and/or interventions: About 33 years ago, the hall was plastered with lime made from shells. The lime was bought from someone in the village who used to prepare the lime. Earlier, the 'sopo' (traditional seats in the veranda) was built with mud. About 30 years ago, they were rebuilt with cement. Two additional rooms were built in laterite masonry about 12 years back. Other alterations made through the years include closure of doors using laterite-stone and mud-mortars, replacement of 'Country-tiles' by 'Mangalore-tiles', wooden columns around the courtyard were replaced with brick columns because the older ones were damaged by white-ants; only one wooden column remains. (The family has also salvaged some wooden columns from a nearby temple, when they the old earth-built temple was being rebuilt in laterite masonry.) Earlier, there were wood-burning-stoves and a wooden loft in the kitchen (the door to the loft can still be seen), which were probably taken-off because these trapped smoke in the house and spiders built many webs. A room added on the rear of the house; it serves as a shop for tourism purpose.

Building in use or not: Still in use.

Building at risk: No.

Information given by: Ms. Tanshekar, owner; Gauri (36 years old), daughter-in-law; Shridar, Ms Tanshekar's brother-in-law.

Other important data: Ms. Tanshekar expressed that earthen-houses are good for health. They facilitate waking up early in the morning, earthen-floors keep the knee-joints healthy even during old age, and temperatures are cooler inside these houses. These aspects, she says provide for a balanced and healthy life. Besides, earthen houses are cheaper to build as all you need is earth, water and labour.

Perspectives of the building



Earth used & Typology



TECHNICAL DATA

Base-course: In earth or laterite-and-earth masonry.

Flooring: Cow-dung.

Buttresses: None.

Corners: In laterite masonry on lower walls only.

Openings: The house has an inner courtyard. There are about two doors and 10 windows.

Roof type: 'Mangalore-tiles'.

Thickness of exterior walls: 70cm.

Distinct architectural details: Intricate wooden pillars once supported the veranda around the inner courtyard. Most of them are now replaced with fired-brick pillars.

Observations: Wooden beams supporting lofts visible on exterior walls.

TYPOLOGICAL DATA (rammed-earth / cob)

Description of earth used:

Dimensions of 'lifts': 34cm, 29cm (second and third lift on rear facade).

Mortars:

Plasters, pigments and/or paints: Only the porch is plastered and painted (exterior). Only the hall is plastered and painted (interior).

Distinct characteristics: Laterite-masonry in many parts of the walls.

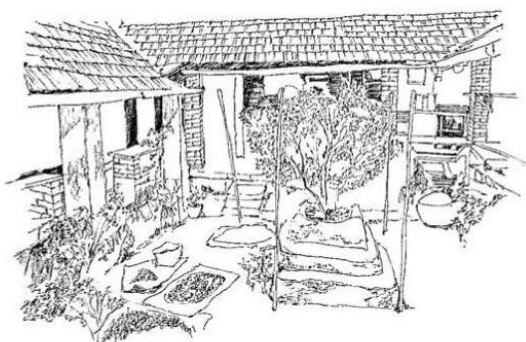
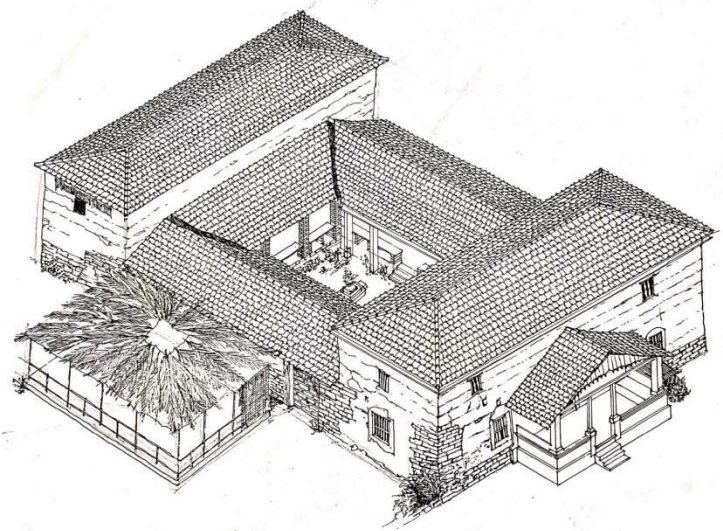
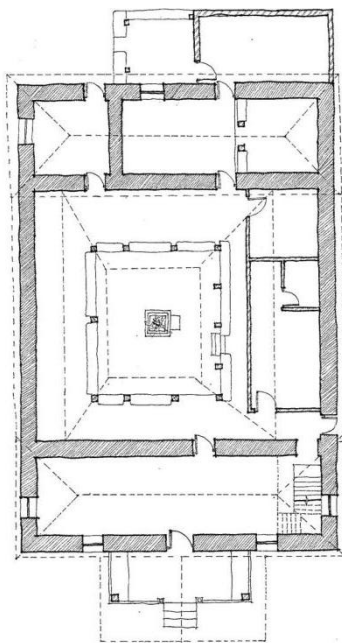

[Drawings by Lionel Afonso, 2018-2019]

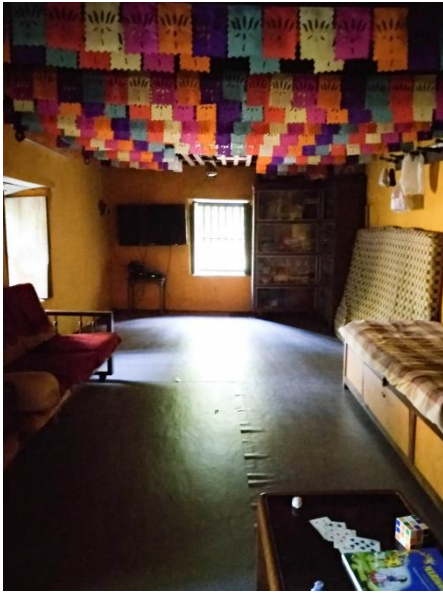

Interior view.



Restorations and/or interventions: Earlier, there used to be a loft in the kitchen, which is now taken-off. The door to the loft can still be seen.

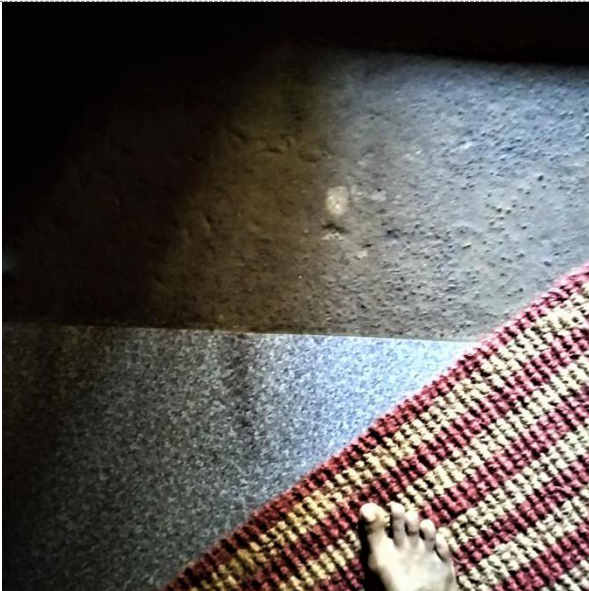

Maintenance and repairs: In the hall, the cow-dung floor is retouched less often as it has a temporary covering, which protects the cow-dung floor.



Openings: Inner courtyard.



Distinct architectural details: Intricate wooden pillars once supported the veranda around the inner courtyard. Most of them are now replaced with fired-brick pillars.

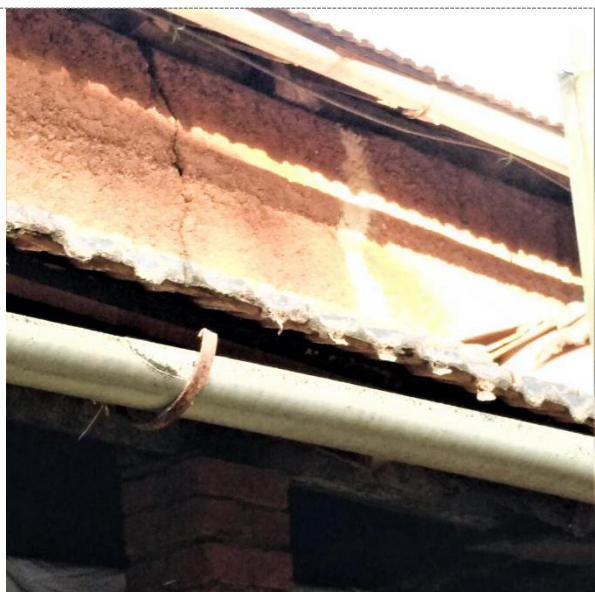

Damages incurred / problems faced: Cracks.

CARE AND CONTINUITY

CONDITION ASSESSMENT

Damages incurred / problems faced: White ants attack roof framework, some years ago a crack developed during an earthquake. (Also refer 'Challenges faced today' section.)

Observations: Cracks.

MAINTENANCE AND REPAIRS

Preventive conservation:

Periodic interventions:

Roof: Every three years, the roof is repaired. Wood that is infested by white-ants is changed, and the tiles are removed and rearranged. If the tiles break during the monsoon, Ms. Tanshekar's son replaces them immediately. If the roof is left to leak, it damages the flooring inside of the house.

Floor: The floor is redone with a fresh layer of cow-dung. In the hall, the floor is retouched only once in a year because it has a temporary covering, which protects the cow-dung floor. In the other rooms, it is applied every 15 days, once in a month, or once in two months. In the interior part of the house, cow-dung is applied by hand. In the courtyard, the slurry is poured onto the floor and spread with a worn-out stick-broom ('*kutalo*' in Konkani). The owners either apply the cow-dung themselves or hire workers.

'Tulsi vrindavan' ('*tusal*' in Konkani) (Hindu religious symbol): The earthen 'tulsi vrindavan' is covered with tarpaulin before the rainy season. If this is not done, the corners break-off.

Repairs: Crack that developed because of earthquake was filled-up with cement about 2-3 years back.

Observations:

Other information:

Challenges faced today: Dampness in the floor during rainy season, rats bore holes in the walls.

Future plans: The owners want to maintain the house, especially because tourists come to see it.

5. RESEARCH REPORT — GOA

In keeping with the title and aims of this study, the surveyed buildings were analysed to understand the:

- Local building cultures that prevailed in regions within Goa
- Construction details
- Conservation methods employed to maintain the buildings

5.1. ANALYSES OF LOCAL BUILDING CULTURES — GOA

In Mariana's study ('Le Pise d'Alentejo' (2000); 'Taipa no Alentejo. Rammed Earth in Alentejo' (2007), 40 case-studies were conducted. They were categorised into nine study areas i.e. 'Region A' to 'Region I' based on their location, and a comparative analyses was drawn to understand the distinct local earth building cultures that prevailed in each of these regions within Alentejo.

Following Mariana's methodology, in this study, 'Comparison of the Vernacular Earthen Architecture of Goa (past Portuguese colony in India) and Alentejo (Portugal): Local Building Cultures and Conservation Approaches', the 16 case-studies conducted in Goa were grouped into three study areas i.e. 'Region A' to 'Region C', according to the 'talukas' (administrative divisions) the structures were located in. The local earth building cultures that exist in the different regions within Goa were analysed accordingly.

- 'Region A' — Salcete, South Goa (Twelve case-studies: Survey nos. 1, 2, 3a, 3b, 4, 5, 6, 7, 8, 9, 10, 11).
- 'Region B' — Sanguem, South Goa (Three case-studies: Survey nos. 12, 13, 15).
- 'Region C' — Pernem, North Goa (One case-study: Survey no. 14).

5.1.1. 'REGION A' — SALCETE, SOUTH GOA

Location (village)

Colva — Survey nos. 1, 2, 4, 5, 6, 7, 8.

Benaulim — Survey nos. 3a, 3b.

Majorda — Survey nos. 9, 11.

Seraulim — Survey no. 10.

Construction technique(s)

Cob ('mathe ghor' in Konkani) — Survey nos. 2, 3a, 3b, 6, 7, 8, 9.

Likely to be cob — Survey nos. 1, 4, 5, 11.

Adobe-brick ('box' in Konkani, which is derived from English) — Survey nos. 4 (gables and kitchen walls), 10 (extension).

'Lift' heights (*a layer of earth in earthen constructions is referred to as a 'lift'; in this context, if layers exist within a 'lift' they are often simply called 'layers'.*)

Varied from one 'lift' to the other, and from part of the same 'lift' to the other — Survey nos. 1, 2, 3a, 4, 5, 6, 7, 8, 11.

Unclear — Survey no. 3b.

Cannot be determined — Survey no. 9.

Adobe-bricks dimensions

24x14cm, 30x14cm, 34x14cm (varied lengths) — Survey no. 4 (gables and kitchen walls).

43x19cm — Survey no. 10 (extension).

Exterior walls thickness

45cm — Survey nos. 1, 2, 3a, 6, 11.

43cm — Survey no. 3b.

47cm — Survey no. 4.

44cm — Survey no. 5.

46cm — Survey no. 7.
42cm — Survey no. 8.
50cm — Survey no. 9.
26cm — Survey no. 10 (adobe-bricks).

Soil types

Depending on the colour, two main types of soils were identified:

- Yellowish soil; includes clay, sand, and rubble (Survey nos. 1, 3a, 3b, 4, 5, 7, 8, 9, 10).
- Red, lateritic soil with lots of rubble (referred to as '*dongraoilli matti*' or '*tambdi matti*' in Konkani, which literally translates to 'soil from the hill' or 'red mud' respectively) (Survey nos. 2, 6, 11).

Walls

The 'lift' heights of the cob structures varied greatly from one 'lift' to the other, as well as from one end of the wall to the other. This was probably because these are cob houses constructed manually without using any form-work. (The defined size of the form-work would have maintained uniformity in 'lift' heights. Besides, the absence of form-work in construction is also evident by the fact that the 'lifts' do not display any vertical joints.) In Survey no. 9, the 'lift' joints were not visible; the wall displays a uniform finish. Dented marks indicate that the walls were compacted using a baton.



Image 67: 'Lift' joints visible (Survey no. 6).



Image 68: 'Lift' joints not visible; the wall displays a uniform finish (Survey no. 9).

The wall thickness ranged from 42-50cm.

Most houses found in 'Region A' were built with a yellowish soil; the shades sometimes varied (Survey nos. 1, 3a, 3b, 4, 5, 7, 8, 9, 10). In some cases, the soil was more sandy with lesser quantities of clay (Survey nos. 1, 3b, 4, 9, 10). In others, there were significant quantities of both, sand and clay (Survey nos. 5, 7, 8). Generally, top soil tends to be more sandy with more rubble. 'Menki matti' found more in depth is more clayey and contains almost no rubble.



Image 69: Generally, top soil tends to be more sandy with more rubble.

A mix of laterite and other rubble were present in almost all the studied buildings. Lime pieces, roof-tiles pieces, sea-shells (all these buildings were situated within a radius of 1-3km from the Arabian Sea), etc. were also spotted in the earthen walls. (Survey nos. 3b, 4, 5, 7, 8). The rubble and other matter were however rarely seen on wall surfaces, but were spotted on eroded or damaged parts of the walls. This was probably because on completing the construction of each 'lift,' the surfaces were beaten with a wooden baton to compact and strengthen the wall, as well as to achieve a neat and smooth finish. This act is likely to have pushed the rubble and other solid matter on the inside.

Three (out of 11) houses were constructed with red, lateritic soil (Survey nos. 2, 6, 11). This soil type is mainly clayey and contains a lot of rubble, especially that of laterite. Roof-tile pieces were also spotted in the earthen walls (Survey no. 2).

It must be noted that though the red coloured lateritic soil is found on hills, only one house (Survey no. 6) out of the three (Survey nos. 6, 7, 8) that are situated just a few meters from a hill was built using red soil. The other two houses built with this soil type had hills at least about a kilometre away from the house (Survey nos. 2, 11). This indicates that the building soil was not necessarily sourced from within the immediate surrounding of the house, as commonly believed. Some narratives indicated that sometimes, red soil was bought from another place for a price.

The adobe-bricks used in this region displayed varied dimensions. Even on the same wall, the lengths varied: 24x14cm, 30x14cm, 34x14cm (Survey no. 4 — gables); 43x19cm (Survey no. 10). The earth used to fabricate the adobe-bricks in Survey no. 4 was clayey; the same soil was used as mortars, as narrated by the owner-builder. The earth used for adobe-bricks in Survey no. 10 was sandy and contained rubble.

Building typology

All the cob buildings surveyed in the region had a simple typology i.e. without mortars and other materials between 'lifts'.

Most owners confirmed that the technique used to build these houses was cob (Survey nos. 2, 3a, 3b, 6, 7, 8, 9, 11). Some owners were unaware of the technique used because their houses were probably built by their forefathers way before they were born (Survey no. 5), or by their in-laws before they married and moved into the house (Survey nos. 1, 4). However, the lack of uniformity in 'lift' heights, and absence of vertical joints indicate that these are cob constructions.

In Survey no. 11, there were holes along the horizontal 'lift' joints, which perhaps indicates the use of form-work in cob construction.



Image 70: Holes along the horizontal 'lift' joints, which perhaps indicates the use of form-work in cob construction (Survey no. 11).

All the laypeople, including owner-builders, who were interviewed in the region, described cob as the technique used to build buildings in the past (without form-work) — Survey nos. 4 and 10, which had adobe-bricks were exceptions. The inhabitants said that they usually built their cob houses themselves with help from neighbours. Inhabitants of the Vanelim neighbourhood (Survey nos. 6, 7, 8) also spoke about workers from the 'Gauda' tribe of Goa, who came to build and repair their earthen houses. The earth was sourced from in and around the ponds (called 'gairo' (singular), and 'gairé' (plural) in Konkani) found in nearby agricultural fields.

Specialised masons also existed in Salcete. Mason Bernardo Sequeira (67 years old when interviewed in May 2018; passed-away: 1954–2018) from Seraulim village too explained that the soil was sourced from agrarian fields. A hole of about 1ft deep was dug into the ground and the mud was put aside. Some earth was pulled out from the pit and shaped into a ball that comfortably fitted in the fist of the palm. The mud balls were then left to dry under the sun, in the open fields. It was regarded that the harder the ball gets on drying, the better the soil for construction. Bernardo expressed that cob constructions are better than adobe-brick or rammed-earth buildings. He explained that less water is used while preparing the soil for rammed-earth walls, which allows for lesser consolidation of the soil particles after the walls are dry. Thus, on receiving heavy rainfall, the soil in the rammed-earth walls tend to break loose. Rammed-earth walls display a neat finish due to the use of form-work but are of a inferior quality, for Goa's climatic conditions. He added that if you later want to extend the height of the building, adobe-bricks can be used on the top of cob walls. However, a cob 'lift' cannot be built over adobe-brick walls because cob is stronger and the adobe-brick walls would not be able to sustain its weight.

Bernardo said that the size of a adobe-brick should not exceed 26cm in height, and should be about 30cm in length. Otherwise, they tend to break while being carried. He was also the only one to call adobe-bricks or its mould 'caix' ('caixa' means 'box' in Portuguese).

Base-course and corners

In Goa, the base-course, which may comprise laterite-stones along the exterior walls, and earth on the interior walls (as explained by mason, Bernardo). This first layer is called 'tor,' 'teno,' or 'intuj' in Konkani.

Five (out of 11) houses studied in this region had a laterite-and-earth masonry base-course (Survey nos. 3a, 3b, 4, 9, 10, 11). While most laterite-stones were blocks of roughly about 46cm (length) x 17cm (height), the base-course in of Survey no. 4 had crudely shaped stones. Three houses had an earth base-course (Survey nos. 1, 5, 8). In Survey no. 2, it was unclear whether the base-course was constructed with earth or in laterite-and-earth masonry. In Survey no. 6, the materials used in the base-course could not be viewed as it was covered with an earthen gradient at the foot of the wall. In Survey no. 7, external walls were plastered and painted and the base-course was not visible, but it seemed that the wall- base of one facade wall was wider than the upper wall.

The corners were either built in earth (Survey nos. 2 — bigger wall; 3a — north-west corner; 8) or in earth and laterite (Survey nos. 1, 3a, 6, 9, 11). The earth and laterite corners took various forms: a laterite-stone sits above the earthen base-course (Survey no. 1), laterite-and-earth masonry (Survey no. 3a), earth with laterite-stones at intervals (Survey nos. 6, 11), laterite masonry on lower walls only (Survey no. 9). Two of the surveyed houses contained laterite-and-cement pillars in the corners; these were not an original to the structure but were added later (Survey nos. 4, 5). In the rest of the cases, the corners were difficult be determined.

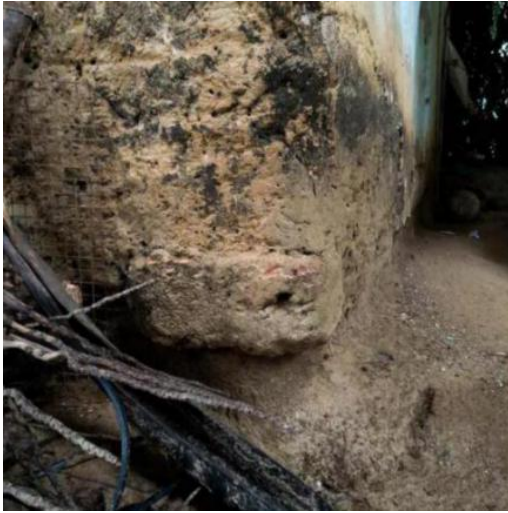

Image 71: Corners; a laterite-stone sits above the earthen base-course (Survey no. 1).

Image 72: Corners; laterite-and-earth masonry (Survey no. 3a).



Image 73: Corners; earth with laterite-stones at intervals (Survey no. 11).

Image 74: Corners; laterite-and-cement pillars; not original to the structure (Survey no. 4).

In Survey no. 2, one wall was replaced with a laterite-and-cement masonry wall. The corners where the earthen walls intersect with the laterite-and-cement wall, displayed laterite-and-earth as well as laterite-and-cement corners. It is hard to say whether the laterite-and-earth corners formed part of the original construction.

Survey no. 10 is an extension to a laterite masonry structure; it originally constituted three adobe-brick walls. The rear adobe-brick wall was later torn down and replaced with a cement-and-laterite. As only two parallel adobe-brick walls remain, the corners could not be determined.

Buttresses and tie-rods

No buttresses or tie-rods were spotted in any of the buildings surveyed in this region.

5.1.2. 'REGION B' — SANGUEM, SOUTH GOA

**Salgini village in Sanguem 'taluka' is a forest settlement situated in the hills of the Western Ghats, a UNESCO (Natural) World Heritage Site. All the houses are in earth, except one which was recently constructed in laterite-and-cement masonry. Even today, earth buildings continue to be built by the owners themselves with help from other villagers.*

Location (village)

Salgini — Survey nos. 12, 13.

Neturlim — Survey no. 15.

Construction technique(s)

Likely to be cob, owners refer to it as 'taip,' indicating rammed-earth — Survey no. 15.

Rammed-earth — Survey nos. 12, 13.

'Lift' heights

Varied — Survey no. 15 (cob).

Cannot be determined — Survey nos. 12, 13 (rammed-earth).

Exterior wall thickness

40cm — Survey no. 12.

32cm — Survey no. 13.

70cm — Survey no. 15.

Soil types

Two main types of soil have been identified:

- Yellow-brown-red coloured soil, more clayey than sandy. Presence of rubble, especially laterite — Survey nos. 12, 13.
- Red, lateritic soil with lots of rubble i.e. lateritic soil — Survey no. 15.

Walls and building typology

As in 'Region A', the heights of the cob 'lifts' in 'Region B', Neturlim (Survey no. 15) varied from one 'lift' to the other, as well as along the same 'lift'. Though the owners referred to the house as 'taipache ghor' (in Konkani), which translates to rammed-earth house, the lack of uniformity in 'lift' height and lack of evidence of holes left by rammed-earth form-works suggests that it is a cob construction. The wall thickness was 70cm. The recent cottages built around the house for tourism purpose are in rammed-earth; the owners have parts of the form-work.

With regards to the soil in walls of Survey no. 15, it was not possible to know its exact source as the house was 250 years old. However, the red lateritic soil makes it evident that it was brought from a hill or mountain.

Rammed-earth buildings were also identified in this region i.e. 'Region B', Salgini (Survey nos. 12, 13). The 'lifts' however, could not be determined as the walls displayed a smooth and uniform texture. As explained by the owner-builders, the holes left by the rammed-earth form-work were covered-up using a stick, and the 'lifts' were beaten with a wooden baton during construction. This was done to compact the walls and realise a neat finish. The owner-builders also reported that laterite-stones were randomly used in the construction of the walls; these however are not visible on the wall surfaces. The wall thickness varied from 32cm (Survey no. 13) to 40cm (Survey no. 12).

The inhabitants explained that before, houses were 'hand-moulded', suggesting cob structures. Today, they are built using shutters i.e. rammed-earth (they referred to them as 'taip' in Konkani). They added that 'lifts' of the 'hand-moulded' houses tend to bulge during construction, in which case they are trimmed and compacted using a wooden baton. The soils in the rammed-earth walls however, tend to break loose after construction (as also explained by the Mason, Bernardo in 'Region A').

In Survey no. 12 and 13, the structures are situated at the base of a hill. The soil for construction was taken directly from the hill, as confirmed by the owner-builders. This hill soil however, was yellow-brown-red in colour.



Image 75: Rammed-earth 'lifts' could not be determined as the walls displayed an uniform texture. The walls were beaten with a wooden baton during construction to compact them and realise a neat finish (Survey no. 13).

Base-course and corners

In two case-studies (out of three), the base-course of the whole house was in earth (Survey nos. 12, 13). In Survey no. 15, some walls had an earthen base-course and others had laterite masonry.

Similarly, the corners were in earth in Survey nos. 12 and 13. In Survey no. 15, the lower walls had laterite masonry corners, and the upper walls were in earth.

In Survey no. 15, some parts of the walls were also built in laterite masonry.



Image 76: Corners; lower walls in laterite masonry, upper walls in earth. Some parts of the walls were also built in laterite masonry. (Survey no. 15)

Buttresses and tie-rods

No buttresses or tie-rods were noticed in any of the buildings surveyed in this region.

5.1.3. 'REGION C' — PERNEM, NORTH GOA

**Goa's best known masons hailed from Pernem 'taluka'. However, when visited Oxelbag area in Dhargalim VP village, where at least one mason resided in every house, only one remaining earthen house was found. Most others were demolished and reconstructed in laterite-and-cement masonry. Though this structure had all its walls plastered and thus did not meet the selection criteria for this study, it was included because of the significance of its location.*

Though Goa's masons traditionally built with earth, they evolved with time, and later built in laterite-and-earth masonry, and then in laterite-and-cement.

The elderly masons (60+ years) in Pernem have memories of their fathers building with earth, from whom they learnt the craft. In their lifetime however, they have often engaged in laterite masonry construction and other jobs as well. Their children are currently employed as engineers, private and government employees, etc.

Location (village)

Dhargalim VP — Survey no. 14.

Construction technique(s)

Claimed to be rammed-earth — Survey no. 14.

'Lift' heights

Cannot be determined — Survey no. 14.

Exterior wall thickness

47cm — Survey no. no. 14

Soil types

- Red, lateritic soil with lots of rubble — Survey no. no. 14.

Walls and building typology

The walls were 47cm thick, built with laterite soil.

The house is situated at the base of a hill, and the soil for construction is likely to have been sourced from that hill. There is a pit at the side of the house. It is possible that the mud used for construction was dug from there. The pit is now shallow because it has probably been filled-up over the years by debris washed down from the hill by rainwater.

The typology could not be observed as all the walls of the house was plastered.

However, when speaking to the masons in the area, Babu Shabi Gadakar described the cob technique. Whereas another mason, Babuso A. Mandrekar described rammed-earth and adobe-brick constructions (Bapu was 67 and Babuso was 78 years old when they were interviewed in 2018). Babuso mentioned that about 2-3 layers of adobe-bricks were used between the stone-and-earth foundation, and the rammed-earth walls. The adobe-bricks stayed below ground level. The mason still had his adobe-brick mould with him.



Image 77 and Image 78: Mason Babuso's adobe-brick mould.

As for rammed-earth constructions, Babuso mentioned that the holes left by the rammed-earth form-work were filled-up with earth, and the 'lifts' were then batted with a wooden baton.

Base-course and corners

The base-course is in laterite masonry.



Image 79: Evidence of laterite masonry base-course (Survey no. 14).

The materials used to build the corners are hidden behind the plaster.

Buttresses and tie-rods

Nether buttresses nor tie-rods were noticed in this house.

5.2. CONSTRUCTION DETAILS — GOA

The variety of buildings and number of architectural aspects analysed for this study presented a wide array of subjects for comparing the regional building cultures within Goa. However, in order to limit the approach and make it achievable, three aspects were chosen.

- Soils, construction techniques and building typology.
- Construction details.
- Mortars, plasters, pigments and/or paints.

5.2.1. SOILS, CONSTRUCTION TECHNIQUES AND BUILDING TYPOLOGY

In this study, an attempt has been made to understand how rammed-earth typologies were adapted to the soils of the regions where these rammed-earth buildings were located. These analyses were based on direct observation, rather than laboratory analyses.

The majority of the soils found in Goa are either 'lateritic' or 'loams'.^{[276][277]}

Three major soil types have been identified in relation to the regions visited, and buildings surveyed in Goa for this study. Based on mere observation, mainly of colour, the soils used in construction have been grouped into three categories.

- Yellowish soil; includes clay, sand, and rubble ('Region A' — Survey nos. 1, 3a, 3b, 4, 5, 7, 8, 9, 10).
- Red, lateritic soil with lots of rubble ('Region A' — Survey nos. 2, 6, 11; 'Region B', Neturlim — Survey no. 15; 'Region C' — Survey no. 14).
- Yellow-brown-red soil, more clayey than sandy ('Region B', Salgini — Survey no. 12, 13).



Image 80: Yellowish soil; includes clay, sand, and rubble (Survey no. 4).

Image 81: Red, lateritic soil with lots of rubble (Survey no. 6).

Image 82: Yellow-brown-red soil, more clayey than sandy (Survey no. 13).

Yellowish soil that naturally includes clay, sand, and rubble. (Survey nos. 1, 3a, 3b, 4, 5, 7, 8, 9, 10). The quantities of clay, sand, and rubble varied from house, probably depending on the exact site the soil was sourced from. Lime pieces, roof-tile pieces, and sea-shells were also found in the walls of these houses. 'Region A' is along the Arabian Sea coast, which explains the soil composition, especially the sand and sea-shells.

Red, lateritic soil with lots of rubble (referred to as '*dongraoilli matti*' or '*tambdi matti*' in Konkani, which literally translates to 'soil from the hill' or 'red mud' respectively) (Survey nos. 2, 6, 11, 14, 15). This soil naturally contains a lot of clay. Roof-tile pieces were noticed in one of the houses built with this type of soil (Survey no. 2). As the Konkani appellation suggests, this mud was brought from the hills. Three (out of 11) structures studied in this region were situated near the base of a hill (Survey nos. 6, 7, 8). However, only one of them was built with red, lateritic soil (Survey no. 6). This indicated that the construction soil was not always got from the immediate surroundings of the construction site, as commonly accepted. Some owners said that red soil was sometimes bought for a price.

Roof-tile pieces were found in structures built with yellowish coloured soil, as well as red soil. Discarded materials such as these, found in the surroundings were probably added to the construction soil.

²⁷⁶ Singh, Newsletter, ICAR Research Complex for Goa, p.1

²⁷⁷ Dessai, Geology and Mineral Resources of Goa, p.291-292

Bernardo, the mason said that red mud demanded more compacting i.e. beating with a wooden baton — than the yellowish soil. The need for more compaction could be justified by the fact that red soil is naturally more clayey, whereas the yellowish mud contains clay and sand. In case of the latter, the small soil particles i.e. clay, and bigger soils particles i.e. sand, naturally allows for better cohesion and thus demands less batting and compaction.

Yellow-brown-red soil had more clay than sand. In its natural state, it included a lot of rubble, especially that of laterite. (Survey nos. 12, 13).

Three earth construction **techniques** have been observed.

- Cob
(Eleven case-studies (out of 16): ‘Region A’ — Survey nos. 1, 2, 3a, 3b, 4, 5, 6, 7, 8, 9, 11; ‘Region B’, Neturlim — Survey no. 15).
- Adobe-bricks
(Two case-studies: ‘Region A’ — Survey no. 4 (gable and kitchen walls), 10 (extension)).
- Rammed-earth
(Two case-studies: ‘Region B’, Salgini — Survey nos. 12, 13).



Image 83: Cob (Survey no. 2). Image 84: Adobe-bricks (Survey no. 4). Image 85: Rammed-earth (Survey no. 13).

The **cob typology** stayed the same — irrespective of the soil type used in construction — in both the regions where cob structures were identified. The ‘lift’ heights varied on the same wall: from one ‘lift’ to the other, as well as along the same ‘lift’.

Adobe-bricks were used to build whole walls (Survey nos. 4, 10), fill-up gable walls (Survey no. 4), and in foundations (‘Region C’). The sizes of the adobe-bricks varied from case to case. In Survey no. 4, the lengths of the adobe-bricks were not uniform, even though they occurred on the same wall. In Survey no. 10, as only part of the wall was exposed without plaster, it was possible to measure one adobe-brick only; it was bigger than the ones in Survey no. 4. In ‘Region C’, the mason’s brick mould displayed yet another adobe-brick size.

The demarcations of the ‘lifts’ in the rammed-earth constructions were not visible as the walls displayed a smooth and uniform finish (Survey nos. 12, 13). This was because the ‘lifts’ were beaten with a wooden baton during construction. The owner-builders said that laterite-stones were used at random while constructing the walls; traces of these stones are not seen on the wall surfaces.

The owner-builders in Survey nos. 12 and 13 mentioned that before, houses in the village were built using the cob technique, but now the rammed-earth method is employed.

In Survey no. 14, the walls were plastered and the building typology could not be identified. The masons in the region spoke of cob, adobe-brick, as well as rammed-earth constructions. Though the owners in Survey no. 14 referred to their house as ‘taip’ i.e. rammed-earth, there could be a possibility that it is a cob house (as identified in Survey no. 15).

5.2.2. ARCHITECTURAL ASPECTS

- 1) The **heights of the 'lifts'** varied greatly in the cob constructions. Almost every 'lift' on the same wall displayed a different height, and heights varied along the same 'lift' too (Survey nos. 1, 2, 3a, 3b, 4, 5, 6, 7, 8, 11, 15). From among the 'lifts' that were measured, the minimum height recorded was 15cm (Survey no. 2), and the maximum was 69cm (Survey no. 3a). The **dimensions** of adobe-bricks too used on the same wall were not uniform in size: the measurements included 24cm (length) x 14cm (height), 30x14cm, 34x14cm (Survey no. 4); approximately 43x19cm (Survey no. 10). In the case of rammed-earth walls, the 'lifts' were not visible and could not be determined.
- 2) In five cases, the **external wall thickness** of the cob structures was 45cm (Survey nos. 1, 2, 3a, 6, 11). A minimum thickness of 45cm is maintained to allow the builder to comfortably stand on the 'lift' while building it.^[278] In the analysed buildings, the widths varied from 42cm (Survey no. 8) to 70cm (Survey no. 15). The adobe-brick walls were 26cm (Survey no. 10), and the rammed-earth walls were 32cm (Survey no. 13) and 40cm (Survey no. 12).
- 3) Eight (out of 16) structures analysed for this research, clearly displayed a laterite-and-earth masonry **base-course** (Survey nos. 3a, 3b, 4, 9, 10, 11, 14, 15). Six buildings had an earth base-course (Survey nos. 1, 5, 8, 12, 13, 15). Survey no. 15 had a base-course in laterite-and-earth masonry in parts of the house, and in earth in other parts. Stone base-course lowers the risk of water ingress in earthen walls, especially that Goa is a rain prone and humid region.
- 4) The **corners** were in earth (Survey nos. 1, 3a, 8, 12, 13), laterite masonry (Survey no. 3a), laterite-and-earth masonry on lower walls and earth on higher walls (Survey nos. 9, 15), or earth with presence of laterite-stones (Survey nos. 1, 6, 11). Survey no. 3a generally had laterite masonry corners, but one corner was found to have been built with earth. Survey no. 1 had only one laterite stone just above the earth base-course.

In two case-studies, laterite-and-cement masonry pillars were observed in the corners; these were later additions (Survey nos. 4, 5).

Laterite-stones in corners contributed to avoiding the degradation of walls, which could begin at corners.

In buildings where both, base-courses and corners were clearly visible, it was observed that constructions that had an earth base-courses tended to have corners in earth too (Survey nos. 8, 13). Likewise, structures that had laterite-stones in the base-course had them in the corners as well (Survey nos. 3a, 9, 11, 15).

- 5) No **buttresses** or **tie-rods** were observed in any of the buildings surveyed in Goa. Buttresses are usually seen in bigger buildings, such as churches.
- 6) **Holes left by the rammed-earth form-work covered with earth.**
- 7) Almost all the structures visited for this study had **verandas, porches and/or 'sopos'**. Except Survey no. 5, which was a distillery. Some verandas had in-built masonry seats (known as '*sopos*' in Konkani) (Survey nos. 1, 3a, 4, 14, 15 etc.). Some had long wooden seats ('*banc*' in Konkani).



Image 86: Almost all the structures visited for this study had verandas, porches and/or 'sopos'. Some verandas had inbuilt masonry seats. (Survey no. 3a).

²⁷⁸ Lobo, *Earth in Architecture*, p.48

As explained in the introduction section, 'Evolution from the pre-Portuguese to the Indo-Portuguese houses (paragraph 7), the 'sopo' is indigenous to the traditional Goan houses. With the Portuguese influence it took a fancier form with intricate colonnades and railings and evolved into the veranda (referred to as 'balkâmv' in Konkani, and 'balcãõ' in Portuguese).

- 8) In some houses, **decorative wooden pillars** were noticed in the verandas along the exterior facades (Survey nos. 3a, 9) or along the verandas in the inner courtyards decorative wooden pillars. These were more common once upon a time, but a rarely seen today. (Refer respective case-studies for images).
- 9) In all the houses surveyed in this study, a **small, earthen gradient covered the foot of the external walls** (Surveys nos. 1, 2, 3a, 4, 6, 7, 8, 9, 11, 12 — covered with a cow-dung layer, 13, 14, 15). In Survey no. 6, this slope is 45cm high and 60cm wide.

Sometimes, it is like a step giving an impression that the house is on a height (Survey nos. 1, 4, 13 — not built but cut from the natural ground surface, 14, 15). In certain cases, laterite-stones fringe the gradient (Survey nos. 1, 14).



Image 87: A small, earthen gradient covered the foot of external walls (Survey no. 12).

Image 88: Sometimes, laterite-stones fringe the gradient (Survey no. 1).

In some cases, this gradient at the foot of the wall is no longer maintained and is eroded (Survey nos. 1, 2).

The earthen gradient acts as a barrier, and aids keeping rainwater from seeping into the wall. As spelled-out by Romeo (Survey no. 2), if rainwater accumulated around the house and rose by a few centimeters, the slope would prevent the water from entering the wall. However, if there is a flood, the slope would not help.

- 10) In many Goan houses, there is a **setback along the base-course** that demarcates the base-course from the wall above it. This setback may range from 2-5cm (Survey nos. 3a, 7, 9, 11, 14).



Image 89: Setback along the base-course (Survey no. 14).

In Survey no. 4, some parts of the wall-base is eroded and the setback was not clear.

- 11) **Window openings** in the hall and bedrooms tended to be bigger in size than the ones in the kitchen and storeroom (Survey nos. 1, 3a, 7, 9, 11, 12).

On walls with no plaster, it was observed that almost all doors and windows had laterite-stone framing. The facade window of the hall tended to have a particularly well designed laterite-stone frame (Survey nos. 1, 2, 9).

The bigger front facade windows of the hall and bedrooms also tended to have grills (Survey nos. 3a, 7, 12), or not (Survey nos. 1, 9, 11). However, the smaller rear windows of the service rooms had vertical wooden bars (Survey nos. 1, 3a, 7, 9, 11).

The windows in the halls and bedrooms had shutters. Those in the kitchens, storerooms and lofts did not.

Thus, it is evident that front facade windows received a better treatment than rear windows.



Image 90: Front facade window of the hall (Survey no. 3a). Image 91: Rear, service area window (Survey no. 11).

This observation seconds what was cited in the introductory section, 'Evolution from the pre-Portuguese to the Indo-Portuguese houses (paragraph 17 and 18) i.e. public spaces of the house such as halls took a more Indo-European character with wide fenestration, verandas etc. Whereas functional spaces such as service areas stayed traditional in special arrangements and overall design.

- 12) Wherever clearly visible, it was observed that door and window **lintels** were mostly slanted, and opened up to the interior of the house (Survey nos. 1, 3a, 4, 7, 8, 9). This was probably to allow the diffusion of natural light to the interior spaces of the house.

In a few cases, the lintels were simply placed horizontally (Survey nos. 12, 14, 15).



Image 92: Lintels of doors and windows were mostly slanted, and opened up to the interior of the house (Survey no. 3a).
Image 93: In a few cases, the lintels were simply placed horizontally (Survey no. 12).

- 13) An interesting observation was made regarding the **door and window hinges** made for fixing the shutters the frames of the openings.

The wooden shutters constitute a protruded extension in the inner corners, which served as hinges. These elongated corners were loosely fitted into holes made in the lintel, and sill or floor (depending on whether the shutters were of full or half length). This provision facilitated the opening and closing the shutters (Survey nos. 1, 3a, 6, 7, 9).

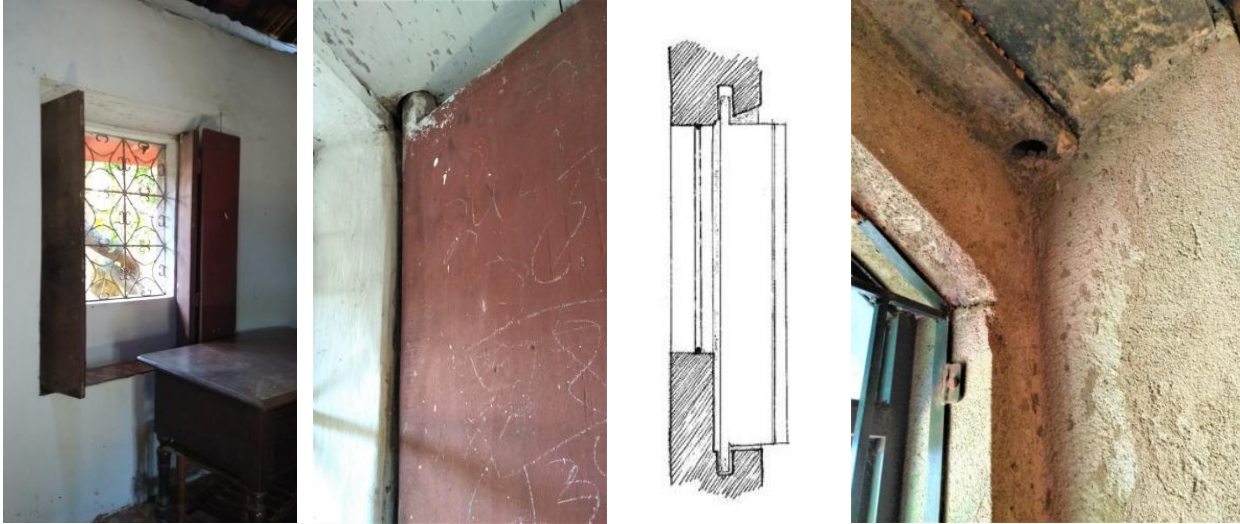

Image 94, Image 95 and Image 96: The wooden shutters constitute a protruded extension in the inner corners, which served as hinges. These elongated corners were loosely fitted into holes made in the lintel. This provision facilitated the opening and closing the shutters. (Survey no. 7). Image 97: Evidence of holes in the lintels suggests that that the old-styled hinged windows once existed (Survey no. 6).

[Section drawing by Lionel Afonso]

In Survey no. 6, the window shutters were replaced with modern ones but evidence of holes in the lintels suggests that that the old-styled hinged windows once existed.

- 14) **Vents** were observed in some houses (Survey nos. 1, 3a, 4, 6, 11). They were observed along wall tops of front façades (Survey nos. 1, 3a, 11), on back façades (Survey no. 4 — one vent only), or side façades (Survey no. 6). Wherever they were observed in the front facade, they featured between the main roof and the lean-to.

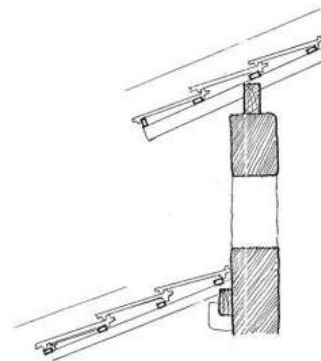

Image 98: Vents along wall tops (Survey no. 3a). Image 99: Section of a vent (Survey no. 11).

[Drawing by Lionel Afonso]

These vents were oriented towards the east (Survey nos. 1, 3a), north (Survey nos. 4, 6) and the west (Survey no. 11).

In Survey no. 3a, vents existed in all the internal walls of the hall.

It is possible that these vents are actually openings left from previous rafters.

- 15) An **earthen pillar** featured inside one house (Survey no. 8). The owner of Survey no. 2 also related that there used to be an earthen pillar inside his house, it was broken down.



Image 100: Earthen pillar (Survey no. 8).

- 16) Sometimes, provisions for **niches and shelves in walls** were made at the time of construction (Survey nos. 3a, 4, 9, 15).

Cabinets with shelves were observed in two houses (Survey nos. 3a, 9). Small niches were spotted in two cases (Survey nos. 4, 15). The owner of the house in Survey no. 4 explained that the niches and shelves (a wooden plank or shelf is called '*phode*' in Konkani) were made in order to place oil lamps on, as back in the days there was no electricity. Today, they are used to keep images of Gods and other objects.

The niches seem to be constructed in laterite masonry, as visible in Survey no. 9, where the walls are not plastered.

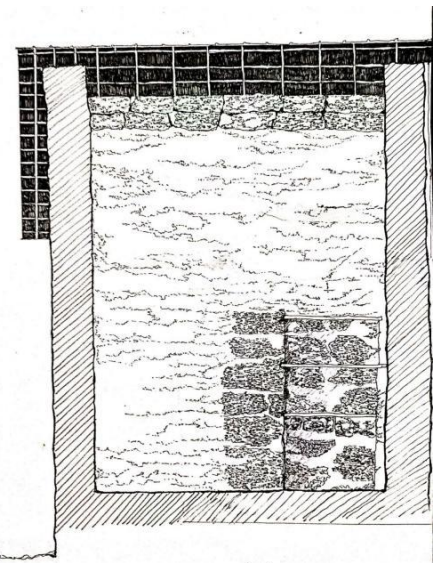

Image 101: Provisions for niches and shelves in walls were made at the time of construction (Survey no. 15).



Image 102 and Image 103: Laterite masonry niches in earthen walls (Survey no. 9).

[Section drawing by Lionel Afonso]



In Survey no. 4, there used to also be a shelf placed on bamboo supports on one of the interior walls. It is now removed, the holes are still visible.

- 17) In traditional Goan houses, halls had to be sometimes temporarily converted into bedroom etc. for privacy, in order to demarcate spaces for various uses. This was often done by mounting a make-shift partition, made of the beetle-nut tree, 'Karanv' (a jungle plant) or the 'Hudo'; this partition could resemble a woven bamboo mat.

Partitions that may fit this description were spotted in two of the surveyed houses (Survey nos. 4, 6). In two of the visited houses, **room dividers made with woven mats** were noticed. They were used to create a bedroom space (Survey no. 4), and to divided the kitchen and the storeroom (survey no. 6).



Image 104: Room dividers made with woven mats (Survey nos. 4, 6).

Survey no. 8 on the other hand, had a simple wooden partition in the hall and dining room, which made it possible to accommodate two bedrooms in the house.

- 18) **Lofts** made with wooden planks were a common feature in many Goan houses, it was primarily used to store agricultural materials. As many families no longer practice agriculture as their primary occupation, many of these lofts have been dismantled.

From the buildings surveyed for this study, four houses still had lofts (Survey nos. 3a, 12, 13, 15). In Survey no. 3a, the loft was in the storeroom. It was used for agricultural reason but is no longer maintained. In Survey no. 12, the loft was in the hall and is used to store agricultural materials such as ladders — not for grains. In Survey no. 13, the loft was in the kitchen and is used to store kitchen items. In Survey no. 15, there are two lofts: one in the hall and the other in the kitchen. Unlike the other lofts observed in this study, which covered part of the room and were accessed with a ladder — the loft in the hall of this house covered the whole hall and was accessed by a flight of wooden stairs. The kitchen loft however, like the other lofts spread across part of the kitchen only and was accessed with a ladder. Initially, it extended over the whole kitchen and was accessed by stairs from another room. The door that led to the old, bigger loft is still visible.



Image 105: Loft for storing agricultural materials such as ladders — not for grains (Survey no. 12). Image 106: Kitchen loft (Survey no. 13).

- 19) **Traditional wood-burning stoves** (*'chul'* in Konkani) were noticed in some of the analysed houses (Survey nos. 1, 4, 7, 12, 13, 14). Though they still exist in these houses, some inhabitants no longer use them.

Wood burning stoves were common place in Goa before the availability of gas stoves. The former were traditionally built with earth, but later included laterite stones as well. They were seen on the inside and/or outside the house.

- 20) Three structures presented **double roofs** (Survey nos. 7, 10, 11). Two had a type of a flap that created an opening in the principal roof. In one case, this roof opening was in the kitchen, just above traditional wood- burning stoves (Survey no. 7). The second case was the bakery, and the flap opened was just above the oven (Survey no. 10).



Image 107 and Image 108: A flap opened in the roof, creating an opening (Survey no. 7).

In the third case, the upper part of the roof thrusts upwards, and is separate from the lower part (Survey no. 12). These kind of roofs are typical of houses that in addition to serving as a residence are also used for agriculture. Though many, if not most houses all across Goa were used for both agriculture and residential purpose (although that's no longer the case), these type of roofs are typical of houses in the hinterlands of Goa. These roofs aided ventilation inside the house.



Image 109: The upper part of the roof thrusts upwards, and is separate from the lower part (Survey no. 12).

- 21) **Wall extensions and various methods for linking the wall top and the roof** were observed on different walls of the same structure.

In some houses, some wall heights were extended using laterite-stones (Survey nos. 1, 2, 3a, 6, 14). Sometimes, the raised part was plastered and painted like the rest of the wall, which made it difficult to verify the construction material used (Survey nos. 1, 3a, 14). The roof rested on the raised extension.



Image 110: Wall heights were extended using laterite-stones (Survey no. 7).



Image 111: Sometimes, the raised part was plastered and painted like the rest of the wall, which made it difficult to verify the construction material used (Survey no. 14).

On some wall tops, laterite-stones were placed at random intervals, on which a wooden plate or rafter was placed. These laterite supports and wooden plate supported the rafters and the rest of the roof framework (Survey nos. 1, 4, 5, 8, 9, 10).



Image 112 and Image 113: On some wall tops, laterite-stones were placed at random intervals, on which a wooden plate or rafter was placed (Survey nos. 5, 8).

Sometimes, the wooden plate directly rested on the wall top, and held the framework (Survey nos. 3a, 7, 11, 12, 13, 15). On gable tops, crude holes were usually made to accommodate the rafters (Survey nos. 1, 3a, 6, 7, 8, 11).



Image 114: Sometimes, the wooden plate directly rested on the top of the wall, and held the framework. On gable tops, crude holes were usually made to accommodate the rafters (Survey no. 3a).

- 22) The ridge of the **roof framework** was made from the trunk of the coconut tree. The trunk was split into two and the fibre from its core was taken out, forming a hollow in the middle. This material was often used for purlins as well. It was also seen along wall tops, where it served as a support for rafters and the rest of the wooden framework (Survey nos. 1, 2, 3a, 4, 5, 6, 7, 8, 10, 11, etc.).



Image 115: The ridge of the roof framework was made from the trunk of the coconut tree. The trunk was split into two and the fibre from its core was taken out, forming a hollow in the middle. (Survey no. 6).

Rafters too were traditionally made from the coconut tree truck. As explained by mason, Bernardo, dead coconut trees were chosen, and treated. Trunks of dead coconut trees were dry of sap, contained less moisture, and thus lasted longer. Today, coconut trees are cut in order to make rafters, and do not last long. A single truck was slit along its length to produce several rafters. Today, other wood is sometimes used as rafters.

Bamboo batons were used in case of 'country-tile' roofs. For 'Mangalore-tile' roofs, they were generally made from the 'banee tree,' which has heart shaped leaves.



Image 116: Bamboo batons were used in case of 'Country-tile' roofs.

In some of the analysed buildings, bamboo and other similar materials were used even in the case of 'Mangalore-tiles' roof framework as well (Survey nos. 4, 12, 13). This could be explained by the fact that the

inhabitants in Survey no. 4 are bamboo basket weavers, and hence used the raw materials in building and maintaining their house. The structures in Survey no. 12 and 13 are based in Salgini Village, a forest community situated in the hills. It is most likely that they procured building materials from their natural surroundings.



Image 117: Sometimes, bamboo and other similar materials were used even in the case of 'Mangalore-tiles' roof framework as well (Survey no. 4).

- 23) As **roof-tiles**, 'country-tiles' were used earlier, which were later replaced with 'Mangalore-tiles'. 'Country-tiles' demanded more maintenance than 'Mangalore-tiles'.

Ventilating roof-tiles are sometimes seen on a Mangalore-tile roofs in Goa (Survey nos. 7, 10, 11). In addition to aiding the air inside the house, the openings in these tiles bring in natural light to the interiors of the house. Glass tiles were also sometimes inserted in the roof to bring in natural light.



Image 118: Sample of a ventilating roof-tile.

[Source: <https://www.exportersindia.com/sreemurugan/single-groove-ventilator-tile-4911478.htm>]

Image 119: Glass tiles inserted in the roof to bring in natural light (Survey no. 3a).

- 24) Almost all structures surveyed in Goa had large **overhangs** that extended from the roofs. In addition, temporary overhangs were usually mounted along wall facades (Survey nos. 1, 7, 9), or only above windows (Survey nos. 6, 8, 14).

The temporary overhangs were traditionally made using palm-leaves (Survey nos. 1, 8), and were usually mounted every year, before the monsoon season. Some have now chosen to use metal-sheet overhangs (Survey nos. 6, 7, 9, 14).



Image 120: Metal-sheet overhangs (Survey no. 9).

These temporary overhangs were seen along the structures' north facades (Survey nos. 1, 6, 7), south facades (Survey nos. 1, 6, 8), and/or west (Survey nos. 7, 9).

Survey no. 7 had one overhang with 'Mangalore-tiles'.

Overhangs protected the walls from rainwater. Those that covered windows, prevented the spatter of rainwater from entering indoors.

- 25) **Provisions for temporary overhangs** were often observed in the surveyed buildings. Wooden pegs were visible all along the lengths of some façade walls (Survey nos. 1, 2, 7, 8, 9, 15).



Image 121: Wooden pegs along the lengths of some façade walls (Survey no. 15).

These were meant to hold palm leaf overhangs, which were habitually installed every year before the monsoon season to protect the wall. In Survey no. 8, separate provisions were made for mounting overhangs on the wall and above the window; make shift hooks were observed.



Image 122: In Survey no. 8, make shift hooks were observed.

In Survey no. 7 the overhang was not temporary; it was a solid, well-constructed one.

These wooden pegs were mostly seen in line with one or two decoratively cut laterite-stones that jutted-out from top of the wall. These stones were probably primarily meant to support the framework of the main roof (Survey nos. 1, 2, 6, 7, 9, 11), but sometimes aided in holding the overhangs as well.



Image 123: Two decoratively cut laterite-stones that jutted-out from the wall top were probably meant to support the roof framework, but sometimes aided in holding the overhangs as well. (Survey no. 1).

- 26) A special detail was observed in the **placement of batons in the roof's framework**. The approximate size of the **batons** was about 5x2.5cm. Generally, the wider surface of the baton is placed on the rafters. However, the last one, along the edge of the roof is placed with the smaller side resting on the rafters (Survey nos. 1, 2, 6, 7, 8, 9, 12, 13, 14).



The last baton along the edge of the roof is placed with the smaller side resting on the rafters.

Image 124 and Image 125: (Survey no. 8). Image 126: (Survey no. 3a).

In Survey no. 13, two instead of one baton was fixed along the ends of the roof's framework. In Survey no. 12, splits of the beetle-nut tree ('*kami*' in Konkani) were used. In the latter case too, two batons were used.

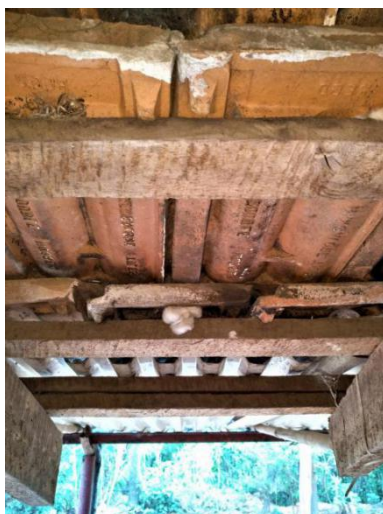

Image 127: Two, instead of one baton was fixed along the ends of the roof's framework (Survey no. 13).

Image 128: Splits of the beetle-nut tree were used as batons. Two batons were used along the roof-line. (Survey no. 12).

This detail lifts the edge of the roof slightly, and directs the downpour of rainwater even further away from the wall.

27) Sometimes, there were small **wooden batons fixed on roof corners** (Survey nos. 3a, 11, 12, 13).



Image 129 and Image 130: Small, wooden batons were fixed on roof corners (Survey nos. 11, 13).

These are seen on the corners of hipped roofs. As explained, by Architect Tallulah D'Silva (Architecture – Goa), the baton holds the edge tile up, or else it will dip lower than the overlapping tile. She added that this detail is also noticed at the edge of the ridge of a Mangalore-tile roof.

28) **Eaves** were spotted on the porch of only one (out of 15) structures surveyed in goa (Survey no. 15). This house was the biggest among those surveyed for this study. In Goa, eaves are often seen in bigger, mansion houses. They usually helped in keeping the spatter of rainwater from entering the houses.



Image 131: Eaves (Survey no. 15).
[Source: <https://www.tanshikarspicefarm.com/#>]

29) Hindu or Catholic **religious symbols** i.e. the 'Tulsi Vrindavan' and 'Cross' respectively, depending on the religion if the owners, were seen on and around some of the surveyed structures.

The 'Tulsi Vrindavan' the Hindu symbol featured in the external courtyard (Survey nos. 12, 13), or the internal courtyard (Survey no. 15).

The 'Cross', the Catholic symbol was seen engraved on the foundation stone placed outside the house (Survey no. 3a), above the oven door and the newly constructed laterite and cement wall in the bakery (Survey no. 10), above the lintel of the main entrance door (Survey nos. 11, 14) and as an independent post in the front yard of the house (Survey no. 14).

The significance and history of religious symbols in Goan houses have been explained in the introductory chapters, 'Beliefs and Practices' (Religious symbols'), and 'Evolution from the pre-Portuguese to the Indo- Portuguese house' (paragraph 4).

- 30) Often, a **palm-leaf extension** was seen at the rear of the house, and sometimes on the side facade (Survey nos. 1, 3a, 4, 6, 8, 9, 10). In Survey nos. 12 and 13, materials such as metal-sheets and wood was used.



Image 132: Palm-leaf extension at the rear of the house (Survey no. 9).

This space was rented out as dwellings, used as an extension to the kitchen, to store fire-wood, house animals, etc.

- 31) **Palm-leaf barriers poised parallel to earthen walls** ('*dollios*' in Konkani) were observed (Survey nos. 1, 3a, 4, 5, 6).



Image 133: Palm-leaf barriers poised parallel to earthen walls protected the walls from rainwater (Survey no. 1).

These were usually constructed every year, before the rainy season in order to prevent rainwater from damaging the walls.

5.2.3. MORTARS, PLASTERS, RENDERS, PIGMENTS AND/OR PAINTS

In the earth structures in Goa, **mortars** were present in those parts of the walls that had laterite-stone masonry (base-courses, window frames, corners, etc.), and/or adobe-bricks. Mortars were observed in all the surveyed structures, except Survey nos. 12 and 13, where no laterite-stone or adobe-brick masonry were spotted on wall surfaces.



Image 134: Mortars were present in those parts of the walls that had laterite-stone masonry i.e. in the base-courses, window frames, corners, etc. (Survey no. 5).

Image 135: Earthen mortars with lime re-pointing (Survey no. 3a).

Wherever the mortars were visible, it was seen that they were usually in earth (Survey nos. 1, 2, 3a, 4, 10, 14). Earthen mortars with lime re-pointing were noted in Survey no. 3a. Sometimes, it was unclear whether the materials used in mortars were earth, lime and/or cement; cement was obviously a later addition (Survey nos. 5, 6, 8, 9).

Whenever it was possible to closely analyse the soil used in mortars (by mere observation), it was observed that the same kind of earth used in the construction of walls was used in mortars (Survey nos. 1, 9). In three of the studied buildings, the earth used in mortars was similar — but sandier, as compared to that used in the walls (Survey nos. 7, 8, 14).

The masons in 'Region B' explained that sometimes building soil was also used in mortars. At times, mortars constituted mud from laterite quarries + lime made from sea-shells (3:1). Water was added to the mix, and it was left to soak for about one working day i.e. 8 hours, during which women would frequently knead the mixture.

Usually, the houses in Goa tend to be plastered; often, the rear wall which was left exposed. Today however, most owners have plastered all the walls of their house. Nonetheless, in order to facilitate the understanding of earthen constructions, buildings with at least one wall without plaster were selected for this study. From amongst the analysed buildings, it was observed that it was usually the principal facades that had **plasters, renders, pigments and/or paints** (Survey nos. 1, 2, 3a, 4, 6, 8, 9, 10, 11, 12, 12, 15).

On the inside, some houses had all the walls plastered and/or painted (Survey nos. 1, 3a, 8, 12, 13). Service rooms such as kitchens and storerooms sometimes displayed an inferior quality surface treatment (Survey no. 1 — included only a single coat of lime, Survey no. 12 — did not include paint) — or were left with no plaster at all (Survey nos. 4, 7, 15). An exception was Survey no. 9, where the interior walls were not plastered, except for the kitchen and one wall in the hall.

Some houses had rooms with no plaster and/or paint (Survey no. 4 — all interior walls, Survey no. 6 — most interior walls, Survey no. 7 — only interior walls of storeroom not plastered, Survey no. 9 — most exterior and interior walls not plastered, Survey no. 15 — only the porch and interior walls of hall are plastered and painted). Usually, secondary buildings too had no plasters and/or paint at all on both, exterior and interior walls (Survey 3b — compound wall, 5 — distillery).

Some houses had a brighter shade highlighting columns, motifs, wall-bases, and borders of doors and/or windows. This was observed on exterior walls, especially on front facades (Survey nos. 3a, 7, 12, 14). In some cases, it was observed on interior walls as well (Survey nos. 3a, 14).



A brighter shade highlighted columns, motifs, wall-bases, and borders of doors and/or windows.

Image 136: This was observed on exterior walls, especially on front facades (Survey no. 7).

Image 137: In some cases, it was observed on interior walls as well (Survey nos. 3a, 14).

As for the materials used to plaster, either lime or cement, and lime-based-paints or synthetic-paints were used. The colours of choice were mainly white (Survey nos. 1, 2, 8, 9), yellow (Survey nos. 7, 10, 14), or blue (Survey nos. 1, 3a, 7). Survey nos. 12, 13, and 15 were painted in other colours.

White was made from sea-shells, yellow from a variety of laterite-stone, and blue from indigo. Indigo was transported from India to Portugal via the in Goa.^[279] Brick-red was also a common pigment seen on facades of Goan houses; it was derived from laterite.

Before, only churches reserved the right to be painted entirely in white; this code was formalised in 1928.^[280] Other buildings, if painted, were obliged to include other colours. Today both, churches and other buildings are free to choose from a range of colours, which are available as synthetic paints. Many choose to replicate the traditional colours i.e. white, yellow, red, blue, etc. using modern paints.

Finally, it was observed that the structures in ‘Region A’, ‘Region B — Neturlim’ and ‘Region C’ shared similar soils, construction techniques, building typologies, construction details, mortars, plasters, pigments and/or paints, etc. Those in ‘Region B’ — Salgini differed in certain aspects. Some of them are mentioned below:

	‘Region A’, ‘Region B’ — Neturlim, ‘Region C’:	‘Region B’ — Salgini:
Soils	Yellowish soil; includes clay, sand, and rubble. Red, lateritic soil with lots of rubble.	Yellow-brown-red coloured soil, more clayey than sandy. Presence of rubble, especially laterite.
Construction technique(s)	Cob and adobe-bricks (structures observed), rammed-earth (masons were aware of and described this technique).	Rammed-earth (structures observed), cob (owner-builders suggested that this technique was once used in the village).
Construction details:		
Wall thickness	Ranged from 42-70cm.	Ranged from 26-32cm.
Lintels	Lintels were mostly slanted, and opened up to the interior of the house.	Lintels were horizontally placed.
Mortars	Mortars were observed in all structures in those parts of the walls that had laterite-stone masonry (base-courses, window frames, corners, etc.), and/ or adobe-bricks.	No mortars or laterite-stone masonry was visible.

²⁷⁹ Nadri, *The Political Economy of Indigo in India, 1580-1930: A Global Perspective*. p.86,97

²⁸⁰ Pandit, *Hidden Hands: Master Builders of Goa*, p.40

5.3. CONSERVATION APPROACHES — GOA

The buildings surveyed were analysed to understand the:

- Damages the building incurred, and the problems and challenges the owners faced
- Maintenance and repair methods employed in the upkeep of the buildings
- Future of the building

5.3.1. DAMAGES INCURRED, PROBLEMS, AND CHALLENGES FACED

- 1) A coconut tree fell and broke the roof-tiles ('Region A' — Survey no. 1), an oak **tree fell and destroyed their old earthen house** ('Region A' — Survey no. 8).
- 2) Building in **ruins**, wall is **tilting** ('Region A' — Survey no. 5)

Roof:

- 3) **Cracking of roof-tiles** as a result of (a) coconuts falling on them from trees next to the house ('Region A' — Survey no. 2) (b) animals, such as cats and monkeys walking and jumping on the roof, especially during the monsoons when the tiles are still damp ('Region A' — Survey no. 2; 'Region C' — Survey no. 14) (c) too much heat, probably during the summer months ('Region A' — Survey no. 2).
- 4) Cracked roof-tiles would lead to **water leakage** during the rainy season ('Region A' — Survey nos. 1, 2, 3a, 8, 11).
- 5) Cracked roof-tiles and water leakage would lead to (a) water ingress in the roof framework causing **damage to the rafters** ('Region A' — Survey no. 3a) (b) if the tiles along the earthen walls cracked, rain water would penetrate through the walls causing them to crack (Survey no. 2), develop holes (Survey no. 4), or even disintegrate ('Region A' — Survey no. 4).
- 6) Roof framework attacked by **termites** ('Region A' — Survey nos. 5, 8, 11; 'Region B' — Survey no. 15; 'Region C' — Survey no. 14).
- 7) **Insects build earthen-nests** on roof's framework ('Region B' — Survey no. 12).

Walls:

- 8) **Walls slightly bulging** ('Region A' — Survey no. 4; 'Region B' — 13).
- 9) **Cracks** were observed on the walls of all of the houses surveyed. These cracks varied from surface cracks to those that split the wall and created a gap in it. Cracks were sometimes observed along corners (Survey no. 1, 8), and near lintels (Survey no. 7). In cases where the wall was extended, a crack appeared demarcating the original earthen wall and the new laterite wall ('Region A' — Survey no. 10). In Survey no. 13 ('Region B'), the crack appeared just after the construction was complete.

Some owners attributed specific reasons as the cause of these cracks. Certain owners said that it was the earthquake ('Region A' — Survey nos. 9; 'Region B' — Survey no. 15), others said that the structure was old, which with the weight of the roof cause the walls to crack ('Region A' — Survey nos. 7, 11; 'Region C' — Survey no. 14). Some owners related that some cracks got wider with time ('Region A' — Survey no. 1; 'Region C' — Survey no. 14), especially with earthquakes ('Region A' — Survey no. 3a).

The owner of the house in Survey no. 7 explained that explained that the wooden lintels were infested by termites and had rotted. The wall above the opening thus had little support to rest on. The weight of the roof added to the pressure on the wall and created cracks near the lintels. When repairing the roof, especially with a hammer, such cracks become longer and wider, and earth falls-off from the walls. ('Region A' — Survey no. 7).

In 'Region A' — Survey no. 10, it was reported that a railway track was laid about 8m from the bakery and vibrations generated by moving trains led to cracks in the earthen-oven. In addition, a stone from the upper wall of the oven once fell off.



Image 138: The lack of support provided by rotting lintels caused the roof to put pressure on the wall, and created many cracks around the window (Survey no. 7).

- 10) **Dampness** in walls, especially on wall bases ('Region A' — Survey nos. 7, 11, 'Region B' — Survey no. 12; 'Region C' — Survey no. 14).
- 11) **Disintegration** of parts of the earthen walls ('Region A' — Survey no. 3b, 4, 7).
- 12) **Holes in walls** ('Region A' — Survey no. 4, 11).
- 13) **Rat holes** ('Region A' — Survey nos. 4, 8, 11; 'Region B' — 12 (rats come because grains are stored in the house), 15).
- 14) **Fire burnt wall surfaces** i.e. plater ('Region A' — Survey no. 7).
- 15) **Chipping of wall surfaces**, especially **corners** ('Region A' — Survey no. 1, 4; 'Region B' — Survey no. 12, 13).
- 16) **Flaking and falling plasters** ('Region A' — Survey nos. 1, 7, 10; 'Region B' — Survey no. 13; 'Region C' — Survey no. 14).
- 17) **Wooden lintels rotting** as a result of termite attack ('Region A' — Survey nos. 7, 8).
- 18) **Wooden pillars rotted** and destroyed due to termite attack ('Region B' — Survey no. 15).

Exterior walls:

- 19) **Erosion of wall bases** ('Region A' — Survey nos. 4, 5), and surfaces ('Region A' — Survey nos. 2, 3b).
- 20) **Bee holes** ('Region A' — Survey nos. 1, 2, 3b, 4, 5, 7).
- 21) **Parrots make holes** in the walls ('Region A' — Survey no. 9).
- 22) **Water run-off** has eroded walls ('Region A' — Survey nos. 3a, 8).

Interior walls:

- 23) **Insects build earthen-nests on wall surfaces** ('Region A' — Survey nos. 4, 5, 7).
- 24) Interior kitchen **walls have darkened because of smoke** from wood-burning-stoves or oven ('Region A' — Survey nos. 1, 4, 8, 10; 'Region B' — Survey no. 12).

Floors:

- 25) **Chipped floors** ('Region A' — Survey nos. 1 (cow-dung), 3a (chip-tiles), 8 (both, cow-dung and cement floors), 9 (cow-dung), 13 (cow-dung); 'Region C' — Survey no. 14 (cow-dung)).
- 26) **Holes in flooring** ('Region A' — Survey nos. 3a (chip-tiles), 8 (cow-dung)).
- 27) When raw mangoes are stored on floors, the **sap damages the flooring** ('Region A' — Survey no. 7).
- 28) **Dampness in floors** during monsoons ('Region B' — Survey no. 15).
- 29) **Roof leakage damages cow-dung floors** ('Region B' — Survey no. 15).

5.3.2. MAINTENANCE AND REPAIRS

- 1) Though Survey no. 5 ('Region A') is now in ruins, it is evident that attempts have been made to salvage the structure. These include temporary measures such as building palm-leaf barriers, using tress branches to support the roof, covering damaged parts of the roof with metal-sheets, etc. (Refer images in Survey no. 5).

PREVENTIVE CONSERVATION

Roof:

- 2) Rafters made from older coconut trees last long. Those made from young coconut trees are prone to termite attack. (As explained in 'Region A' — Survey no. 8).

However, Mason Bernardo ('Region A') said that **dead coconut trees were used for making rafters**. Those made by cutting live coconut trees do not last because they contain sap that attracts termites.

- 3) **Before the roof is installed, the wood is immersed in clayey, water laden soil** (this kind of soil is called '*chikon*' in Konkani) for about 10-15 days. This treatment helps keep white ants away in the long run. ('Region B' — Survey no. 12).
- 4) **Cooking indoors on traditional wood-burning-stoves** lets out smoke and heat. It **keeps the wooden roof framework dry, makes it stronger, and keeps termites away**. ('Region B' — Survey no. 12).

Sometimes, slits of the beetle-nut tree trunk ('*kami*' in Konkani) are used as batons in roof frame. These however, last only upto 5-6 years, especially if not exposed to smoke. ('Region B' — Survey no. 12).

- 5) As the villagers sit by the fire to warm themselves during the monsoons, they **place a blanket in between the roof's framework**. They say that in doing so, the roof lasts longer. ('Region B' — Survey no. 12).

Several local building cultures and architectural details also contribute to the long-term sustainability of the building.

- 6) **Selection of building soils** (refer section '5.1.1. 'Region A' — Salcete, South Goa' (Building typology — paragraph 5).
- 7) **Thick wall widths** (refer section '5.2.2. Architectural Details', point 2).
- 8) **Use of laterite-stones in base-courses and corners** ('5.2.2. Architectural Details', points 3, 4).
- 9) **Earthen gradient at the foot of external walls** ('5.2.2. Architectural Details', point 9).
- 10) **Materials used in the roof's framework** ('5.2.2. Architectural Details', point 22).
- 11) **Overhangs** ('5.2.2. Architectural Details', point 24).
- 12) **Provisions for temporary overhangs** ('5.2.2. Architectural Details', point 25).
- 13) **Placement of batons on roof corners** ('5.2.2. Architectural Details', point 27).

- 14) **Eaves** (point 28).
- 15) **Palm-leaf barriers poised parallel to walls** (point 31).

PERIODIC INTERVENTIONS AND REPAIRS

Roof:

- 16) Before, the houses in Goa had 'Country-tiles', which were later replaced with 'Mangalore-tiles'. All the houses surveyed in this region had 'Mangalore-tile' roofs. As expressed by many, 'Country-tiles' required more frequent maintenance. In cases where the owners remember having country-tile roofs, they said that the roof had to be retouched or repaired every year ('Region A' — Survey nos. 2, 3b).
- 17) With regards to 'Mangalore-tiles', the roofs of all the houses surveyed in Goa required **regular maintenance** i.e. they needed to be cleaned, retouched, repaired and redone periodically. Some owners clean the roofs as and when needed ('Region A' — Survey no. 3a, 9), others replace broken roof-tiles and/or carry out required repairs every year ('Region B' — Survey no. 11; 'Region C' — Survey no. 14), every 2 years ('Region A' — Survey no. 4), every 2-3 years ('Region A' — Survey no. 8), every 3 years ('Region B' — Survey no. 15).

In addition, **every few decades, the roof and its framework needs to be dismantled and redone**. While doing so, wood that is in good condition is reused, and the rest is replaced. Damaged and fragile roof-tiles are also replaced. ('Region A' — Survey no. 3b).

The roofs are usually repaired in the summers, just before the monsoons i.e. in the month of May. An old abraded stick-broom (broom made with the midribs of the coconut frond leaflets; they are common in Goa and are called '*iria san*' in Konkani) is used to clean the roofs.



Image 139: Old abraded stick-brooms used when the roof in Survey no. 7 was repaired in 2018.

Referring to the yearly repairs of 'Country-tile' roofs, the owner in Survey no. 2 ('Region A') explicated that the tiles were removed from the wooden framework and then re-fixed by rearranging them in an orderly manner, one after the other. Broken tiles were thrown away in the process. Thus, on reaching the last row, tiles would fall short and new ones were placed.

Those concerned with the maintenance of 'Mangalore-tile' roofs explained that the tiles are removed either from part of the roof, or from the whole roof, depending on the extent of repairs needed. Then, the wooden framework is repaired: wood infested by termites is replaced, and the framework is readjusted and fastened using a drill and nails. ('Region A' — Survey no. 7; 'Region B' — Survey no. 15). The roof-tiles are then replaced on the framework. In Survey no. 7, when the roof was repaired in 2018, about 5-6 workers were engaged, and they completed the roof work within a day.

- 18) **Panels made with bamboo and hay** are made before every monsoon season. When it rains, these are placed on those parts of the roof where there is risk of water seepage, as well as to prevent roof-tiles from falling and breaking. ('Region B' — Survey no. 12).

Walls:

19) In order to protect walls from rainwater, every year before the monsoons, woven **coconut-palm-leaf barriers** (called '*molla*' in Konkani) were hung on wall facades, palm-leaf barriers ('*dollios*') were built along walls, and palm-leaf overhangs ('*pakadi*') were mounted over window frames. These were replaced every year before the monsoons ('Region A' — Survey nos. 1, 4, 6, 8, 11; 'Region B' — Survey no. 13). In Survey no. 1, a woven coconut-palm-leaf covered a gable wall. In Survey no. 6 ('Region A'), the wall that is covered with barriers is less eroded than the wall that is not. (Refer images in Survey no. 1).

20) More recently, **metal-sheet covers have been** used as overhangs over window facades in order to protect the interiors from the rainwater spatter ('Region A' — Survey nos. 6, 9).

Metal-sheets are also used as roof extensions to protect the walls ('Region A' — Survey no. 7, etc.).

They were also seen sheltering the entrance steps. Metal-sheets above entrance steps have a fold along the rim. This is probably to direct rainwater towards the sides, thus clearing the path to the entrance of the house ('Region A' — Survey no. 11; 'Region B' — Survey no. 13).

21) Today, many houses use **tarpaulin** to cover roofs, overhangs, verandas, gradients along foot-walls, etc. ('Region A' — Survey nos. 1, 4, 3a, 4, 5, 6, 7, 8, 9, 10, 11; 'Region B' — Survey no. 13; 'Region C' — Survey no. 14). These plastic covers are sometimes put before the rainy season and removed after to provide protection from rainwater and winds. In Survey no. 15, the earthen 'tulsi vrindavan' (Hindu religious symbol) is also covered with tarpaulin before the monsoons, in order to prevent the corners from breaking-off.

22) On the interiors, the **earthen-nests built by insects are broken manually** ('Region A' — Survey no. 4).



Image 140: An owner demonstrating how to manually break earthen-nests built by insects on interior walls (Survey no. 4).

23) The houses are **whitewashed and/or repainted** every year before festivals ('Region A' — Survey no. 8 (before the village feast); 'Region B' — Survey nos. 12, 13 (before 'Ganesh Chaturthi festival)).

Traditionally, lime made from seas-shells was used to plaster, render, and/or paint walls. As it created a breathable layer over the wall, it allowed the moisture trapped in the earthen wall to evaporate. In the process, lime plasters, renders, and/or paints would flake-off, and are thus often referred to as a 'sacrificial layer'.

Repairs were done either in 'menki matti' (type of mud) ('Region A' — Survey nos. 3a, 3b, 5, 9, 10; 'Region B' — Survey no. 12), or cement ('Region A' — Survey nos. 1, 2, 3a, 3b, 6, 7, 8, 9, 11; 'Region B' — Survey no. 15).

Roof and walls:

24) In Survey no. 10, when cracks developed on the old, earthen oven, they were covered-up with 'menki matti'. The mud was soaked in a recipient for about two days and then applied to the cracks.

Sometimes, only big **cracks** were repaired with cement ('Region A' — Survey nos. 8, 9; 'Region B' — Survey no. 15), and smaller ones were repaired with 'menki matti' ('Region A' — Survey no. 9).

When cracks developed near windows and put the walls at risk, the window openings were covered-up in masonry to secure the wall ('Region A' — Survey nos. 7, 9). In Survey no. 9, a laterite-stone block was built in order to stabilise the wall.

Earthen mortars were re-pointed with cement ('Region A' — Survey nos. 7, 9, 11).

Cement was applied to the lower part of a wall. This was done with an intention to protect the wall from seeping the rainwater that gets collected near the foot of the wall during monsoons. ('Region A' — Survey no. 8).

- 25) In Survey no. 3b ('Region A'), the gaps created by the **disintegration of earthen walls** were filled-up with 'menki matti' collected from the broken parts of the same building. In Survey no. 7 ('Region A'), the mud that was disintegrated was removed up to a few centimetres deeper than the damaged portion, and refilled with cement.
- 26) In Survey no. 4 ('Region A'), a **hole** at the foot of the wall was filled-up using a dried coconut and mud.
- 27) **Rat holes** were covered using 'menki matti' ('Region B' — Survey no. 12), or cement ('Region A' — Survey no. 8). The owner in Survey no. 8 ('Region A') explained that rat holes have to be patched-up immediately. If not, ants enter the house through them.
- 28) The earthen gradient at the foot of the external wall was covered with a tarpaulin ('Region A' — Survey no. 6), roof-tiles and wood ('Region A' — Survey no. 7), and metal-sheets were observed along wall-bases ('Region B' — Survey no. 12). These were probably meant to **protect lower walls from capillary rise**.

Floors:

- 29) **Cow-dung floors need to be relayed with a fresh layer of cow-dung occasionally** ('Region A' — Survey no. 1), every eight days (Survey no. 13), every two-three months ('Region A' — Survey nos. 4, 9, 11), three months ('Region A' — Survey no. 7), every six months ('Region A' — Survey no. 2), every year ('Region C' — Survey no. 14). However, the owners in Survey nos. 7 and 9 reported that they redo their cow-dung floors less often now i.e. about once a year.

The owners of Survey no. 15 explained that the floor is re-layered every 15 days or once in two months; the hall has a temporary floor covering which protects the floor, hence cow-dung is applied once a year only.

Outdoors, every year after the monsoons, the courtyards and earthen-gradients along wall-bases are redone. The soil is loosened with a pickaxe, and re-rammed. It is finally coated with a layer of cow-dung ('Region B' — Survey nos. 12, 13).

In the interiors, the cow-dung is applied by hand. In the courtyard, the cow-dung is usually applied by pouring the slurry onto the floor and spreading with a worn-out stick-broom ('*kutalo*' in Konkani) ('Region B' — Survey no. 15).

For both exterior and interior walls, the owners themselves apply the cow-dung or they hire workers ('Region B' — Survey no. 15).

- 30) **Red-oxide floors are sometimes repainted in order to keep them from wearing-off**. This is mainly done for aesthetic reasons, especially that the red colour reflects a shine. ('Region A' — Survey nos. 7). However, as mentioned in Survey no. 8 ('Region A'), the red-oxide available in the market today loses its colour as well as shine quickly.

Other problems and challenges faced:

- 31) The owner in Survey no. 2 ('Region A') explained that if a roof-tile cracks during monsoons, it could be replaced only after the rainy season was over, because walking on damp tiles would cause the roof-tiles to crack. However, in Survey no. 15 ('Region B'), the owners said that if broken roof-tiles are not replaced immediately during the monsoons, the water leakage damages the cow-dung floors. In some cases, a bucket is placed inside the house to collect the water that seeps into the house while it is raining.
- 32) As there are **fewer people living in the house** as compared to before owing to decline of employment opportunities in the region, cooking has been shifted from the wood-burning-stoves inside the house to those on the exterior of the house. The wooden roof framework is thus no longer regularly exposed to smoke and heat, and is more susceptible to moisture and termite attack. The roof frame now degrades sooner than it used to earlier. ('Region B' — Survey no. 12).

- 33) The main challenges that most house owners face today is the **lack of expertise**. Those who had the skill have either passed away ('Region A' — Survey no. 1), and it is hard to find workers who maintain and repair roofs and/or floors ('Region A' — Survey nos. 3, 9; 'Region B' — Survey nos. 15; 'Region C' — Survey no. 14), and /or redo cow-dung floors ('Region A' — Survey no. 9).

In Survey no. 1 ('Region A'), Tedoline, the owner expressed that she and her husband used to also make the palm-leaf rainwater barriers i.e. 'mollas', 'dollios' and 'pakadis', but since he died, she has had no help and has not been able to continue doing the same. He used to also source the cow-dung for re-layering the floor. Later, her tenant who lived in the rear extension would do so, but she too passed-away.

The owner in Survey no. 3a ('Region A') specified that the roof is too high and that it is hard to find people who are willing to repair it.

Most expressed that workers had to be hired to replace roof-tiles, and repair the roof ('Region A' — Survey no. 2, etc.). However, some families tend to hire workers only when doing major repairs, reinstalling the roof, etc. The owners carry out minor roof repairs, including the re-layering of cow-dung floors themselves ('Region A' — Survey nos. 1, 4, 9; 'Region B' — Survey no. 15).

In Survey no. 12 and 13 ('Region B'), the construction of the house, including the roof are done by the owners themselves with help from other villagers. Repair and maintenance works are also carried out by owner-builders.

- 34) Spiders enter the house through the gaps between the roof and wall, and form numerous cobwebs. These have to be cleared with a long broom stick about every two months, failing which dust begins to fall from the roof and upper walls ('Region A' — Survey no. 7). Dust gets collected in between roof-tiles ('Region A' — Survey no 8). Dust frequently falls from the roof; it worsens during periods when the house is unoccupied. **Cleaning** the house as often is rather tedious. ('Region A' — Survey nos. 3a).
- 35) One owner reported that a snake once entered the house through the wide gap in the crack ('Region A' — Survey no. 1).
- 36) Some inhabitants expressed that there are times when they **fear that the earth walls might collapse**.

Two inhabitants said that it can get really scary to live in a mud house when it rains heavily. The raindrops hitting the roof, accompanied by thunder and lightening can be very load. Sometimes, it feels like the walls will collapse ('Region A' — Survey nos. 1, 2). The owner in Survey no. 1, who often lives alone told that the house is no longer in a good condition, and that during the monsoon season in the last couple of years, she has been living at a relatives' house.

Cracks near a window lintel have made the wall very delicate. The inhabitants rarely open the window for fear that any kind of movement around the wall, might bring it down. ('Region A' — Survey no. 7).

In Survey no. 8 ('Region A'), the owners used cement to cover a big crack that appeared on the wall because they feared that it would fall.

It was viewed that the earth buildings in all the regions visited in Goa for this survey faced similar damages, problems and challenges, and employed similar methods in the maintenance of the structures. However, some interesting findings surfaced in Salgini village, especially with regards to 'Preventive conservation' (refer '5.3.2. Maintenance and repairs', points 3 5). Using of hay panels to protect roofs from rainwater was also reported only in Salgini (refer 'Periodic conservation', point 18).

5.3.3. FUTURE PLANS

- 1) It was observed that it is a general notion that an earth house needs to be demolished and reconstructed in laterite-and-cement masonry because the latter is believed to be stronger and better.

Six (out of 12) owners clearly said that they intend to reconstruct their buildings in laterite masonry ('Region A' — Survey no. 1, 2, 7, 8; 'Region B' — Survey no. 13; 'Region C' — Survey no. 14).

In case of secondary buildings, it was observed that attempts have been made to salvage the structure, but the owners have neither plans to secure or rebuilt them in the long run ('Region A' — Survey nos. 3b (compound wall), Survey no. 5 (distillery)).

An exception was Survey no. 15 ('Region B'), where the owner cited many health benefits of staying in a mud house. They use the house for eco-tourism and intend to maintain it.

- 2) It must be noted that in some cases, the inhabitants refrain from investing in major repairs and/or are stalled from reconstructing their house, either because they are still tenants awaiting ownership ('Region A' — Survey nos. 1, 4), or because there are many heirs involved and property division is still pending ('Region A' — Survey nos. 3a, 8). As per the Goa Mundkar Protection from Eviction Act 1975, tenants are entitled to their plot of land if they have been living there for generations, and they fulfil certain criteria.

However, as it is a cultural norm to beautify one's house when a family member is getting married, renovations are seen even if ownership is not yet obtained. Survey no. 1 ('Region A') is a good example. The house was renovated in 2019, before a wedding in the family. (Refer images in '4.2. Locations of buildings surveyed and case-studies', Survey no. 1.)



Image 141 and Image 142: House renovated on before wedding celebrations.

- 3) Interestingly, 'Region B' — Salgini, still follows the 'Ganvkari' system, where ownership of land jointly belongs to the villagers, and not to individual inhabitants (Refer 'The 'Ganvkari' or 'Comunidade' system, and land administration' in the introduction).

III. ALENTEJO — PORTUGAL

6. INTRODUCTION — ALENTEJO

Extracted and edited by Chenelle Rodrigues based on the work of Mariana Correia ('Pise d'Alentejo'*, 2000; *'Taipa no Alentejo. Rammed Earth in Alentejo'*, 2007)

6.1. GEOGRAPHY



Image 143: Map of Portugal and location of Alentejo.

[Source: <https://www.visitalentejo.pt/fr/alentejo/carte-de-l-alentejo/connaitre/> (accessed on January 18, 2020)]

“Portugal comprises three discontinuous territorial units: the continent, and the Atlantic archipelagos of Azores and Madeira. The country is in the shape of a rectangle, longer along its north-south axis. It is situated in the western part of the Iberian Peninsula, occupying approximately a fifth of its surface (88,944km²). Portugal is located between parallels 37° and 42° North and meridians 6° and 9.5° West. Its maximum north-south length is of 561km. Its width varies between 218 and 112km. The Portuguese mainland shares 1,200km of its borders with Spain and has a coast that measures 848km.

Portugal is geographically diverse. The contrasts between the northern and southern areas are most evident in the physical aspects of the landscape. The Mediterranean South is flat and dry with rolling plains of land impacted by the lack of summer rains. In contrast, the north is hilly and rocky with a lot of green vegetation as a result of more rainfall and lower temperatures. The sandy beaches distinguish the coast from the inland areas. Yet, the contrasts are even more evident from the demographic, economic and social points of view.

Portugal does not have a strong regional administrative structure (except in the case of the archipelagos) because authority is directed from the central administration to the local authorities, the latter consists of 305 city councils (in 2000). The districts (*'districtos'* in Portuguese) are judicial divisions, but are also a kind of statistical entities. The municipalities (*'concelhos'*) are administrative subdivisions of a district. The parish (*'freguesia'*) is the smallest administrative sub-division and they are under the authority of their respective city council.

Alentejo, the region selected for this study, is the biggest region in Portugal spanning to about 31,500km².^[281] It is geographically located to the south of the Tagus River and the region of Ribatejo region, and to the north of the Algarve region. Alentejo is divided into two sub-regions: Alto and Baixo Alentejo (Upper and Lower Alentejo). The region comprises wide and deep basins and low elevation plains. The highest point of this region (more than 700m) is located on the north-east of Alto Alentejo; it is the Serra de São Mamede.

The populated settlements of Alentejo are the most dispersed of all of the regions in Portugal. The average population density of 22.6 people per km², which is the lowest among the regions in the country (2018).^[282] There are those who live in towns and those who live in homesteads (*'herdades'* in Portuguese) spread across the region. These homesteads are wide expanses of agricultural land, dominated by the *'monte'* i.e. usually the house in which the field workers live.

In the case of Alto Alentejo, a region of higher altitude, the population is also scattered, but not as much as in the south. Sometimes, in the north of the region, the population is concentrated in farms (*'quintas'* in Portuguese) outside the villages.

The economy in Alentejo is mainly linked to agriculture, both farming and animal husbandry. There are fields for growing cereals, forests are marked with cork and olive trees (which produce cork, olives and olive oil for commercial purposes), grasslands for rearing pigs and sheep, and small and large vineyards too dot the landscape. The general lack of water and population subjects the region to the crop rotation system, resulting in periods of fallow land, which in turn, contributes to Alentejo's poor economy.

The eastern region of Alentejo has strong similarities with its neighbours, the Spanish regions of Extremadura and Andalusia, especially with regards to geography, climate, vegetation, and agricultural systems and practices. The character of the land mass that is dominant in the interior regions of Alentejo came partially from the *Reconquista* of the 12th and 13th centuries. The settlements are characterized by a reduced number of remote settlements and scattered *'montes'*. This is the kind of settlement considered *'Inland meridional'*.[”]

²⁸¹ European Commission, *Alentejo Region of Portugal*,

<https://ec.europa.eu/growth/tools-databases/regional-innovation-monitor/base-profile/alentejo-region-portugal>, (accessed January 18, 2020).

²⁸² *Ibid.*

6.2. GEOLOGY

6.2.1. LITHOLOGY

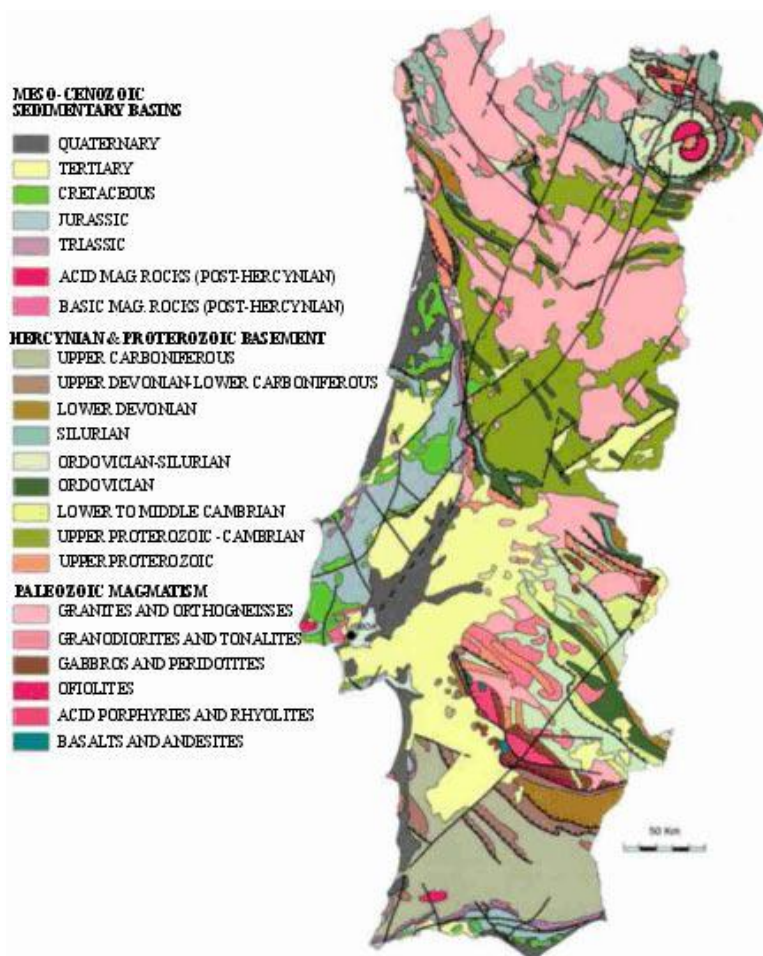

Image 144: Geological map of Portugal.

[Source: https://www.ineg.pt/CienciaParaTodos/edicoes_online/diversos/portugal_geology/texto (accessed on January 18, 2020)]

“From a geographical point of view, Portugal is categorised into three major physical divisions depending their origin, lithology and present shape, which originate from tectonic actions and different erosion processes. The areas are the (1) Iberia Antique Massif (2) Western and meridional sedimentary edges and (3) Tagus and Sado Rivers basins.

From the perspective of lithology, the majority of the rocks found in Portugal are either sedimentary rocks (e.g. calcareous, conglomerates, sandstone, etc.) or metamorphic rocks (e.g. schist, gneisses, quartzite, marble, etc.). In addition, there are some eruptive or magmatic rocks, classified as plutonic (granite) or volcanic (e.g. basalt, volcanic breccias, etc.). These three major rock families are concentrated in the most extensive and ancient part of the country, the Iberia Antique Massif.

The different regions of the country can be categorised based on their rock type. In the northern region, the most common rock is granite, which is present in a large area of the country. The clayey schist have a very uniform composition and texture and is associated with the Pre-Cambrian period. It is found in the centre of the country. In the southern region of Portugal i.e. in Alentejo and Algarve, schist dating back from the Silurian to the Carboniferous period are found. Also, in the Alentejo area there are some Pre-Silurian marbles which are correspond to hard rocks and some eruptive rocks like porphyries and diorites.

The Alentejo region in its south and east is characterized mainly by schist, which is a little or not crystalline at all. The central area contains mainly crystalline rocks, whereas sand and sandstone is found in the western area. Sometimes, calcareous rich subsoil is found in some areas such as Sobral de Adiça, Serpa, Juromenha and Redondo.”

6.2.2. PEDOLOGY

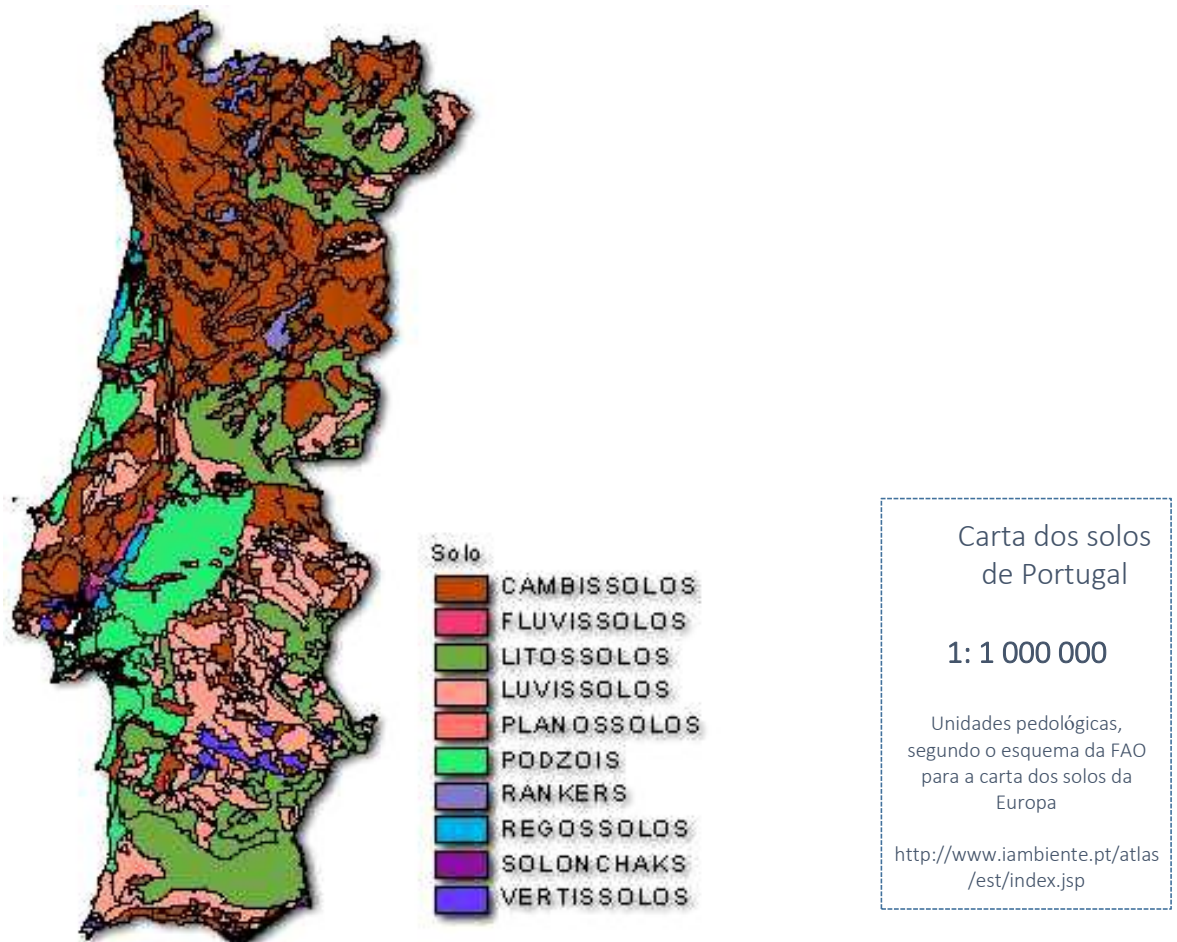

Image 145: Soil map of Portugal.

[Source: <https://www.slideserve.com/henry/classifica-o-dos-solos>]

“There are a wide variety of soils in Portugal. In Alentejo, depending on the extent of their presence, soils can be categorised into three major types (1) lithosoils (2) luvisols and (3) podzosoils. What distinguishes the lithosoils is that they are found in medium mountain range areas and are a result of severe soil erosion. These soils are derive from consolidated rocks. The luvisols are either chromic type or orthic type. The orthic type of luvisols is of special importance to the agricultural areas in the southern area of the country. Finally, the podzosoils in Portugal are orthic and are associated with cambisoils (sandstone and sand). Their particular composition is favourable to resinous trees in the forests, but mainly to the cork trees, which are very characteristic of Alentejo.

The largest part (85%) of the Baixo Alentejo is constituted by soils called ‘galegos’. These soils are considered infertile, and thus are bad for agriculture (which explains the poverty in the region). These soils are composed of thin, poor and rocky soils. They originate from the residues of eruptive rocks, which were deposited on the soils of the Antique Massif. The land in the Sado River basin, near Alcacer do Sal are also considered ‘galegas’. They are composed of the alluviums, which are frequently used in the area to make adobes.

The soils used for the rammed-earth structures in Alentejo were chosen by the masons from a place close the building or wall to be constructed. The origin of such soils vary between the surface weathering of clayey schists, the different deposits on the antique massif or the sedimentary basin layers of the Sado River. Often, on the surface or interspersed within the clay, there is gravel (i.e. schist, quartzite or quartz in vein fragments), which gives consistency to rammed-earth. Sometimes, the required consistency is naturally present in the earth.”

6.2.3. SEISMIC RISK

“Portugal was affected by some earthquakes in the course of the centuries. The more recent and catastrophic ones were registered: 1009, 1344, 1356, 1531, 1755 (Lisboa-Alentejo), 1856 (Algarve), 1858 (Setúbal), 1909 (Ribatejo-Benavente), 1918 (Chaves-Vidago), 1926 (Évora-Beja), 1969 (Cabo de São Vicente). As per the internationally accepted seismic scale, the zones of maximum seismic intensity in Portugal are concentrated around the coast. The intensity varies from VI to VIII. Although the epicentre of the earthquakes were in the Atlantic Ocean, they affected the Portuguese coast. The country’s inland is less seismic in the north (IV and V) and more in the south (VI to VII). The zones of higher intensity are the Tagus River basin (VIII, IX and X), and the Algarve coast (VII and VIII). The zones of lower intensity include Serra da Estrela and the country’s north-east region(IV).

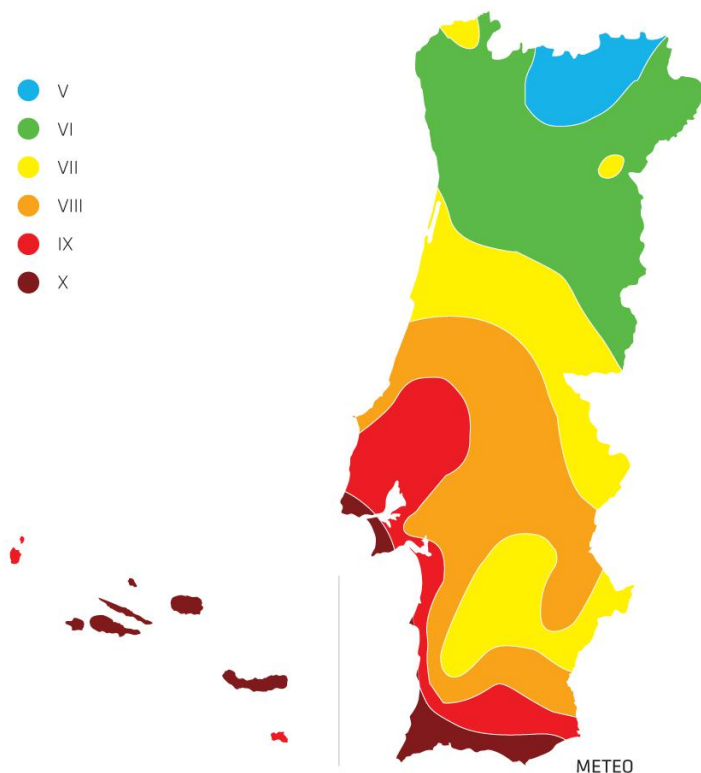

Image 146: Macro seismic intensity in Portugal.

[Source: <https://esg.pt/seismic-v/portuguese-historical-seismicity/>]

As for the Alentejo region, minimal intensity is observed between Monsaraz and Juromenha (V). Alentejo’s inland has an average maximum intensity of VI. The exceptions are the Évora-Beja zones (VII), and Vila Verde de Ficalho (VII). Along the coast as well, the maximum value is VII.

Besides the rating on the international scale of seismic intensity, it is important to consider the frequency of these seismic activities. For example, in the region of Évora, there are references to only a few intense quakes, but several and frequent references to low intensity earthquakes.”

6.3. CLIMATE

“Portugal’s climate varies from the north to the south. Generally, summer is moderately hot and winter is mild. The contrasts which exist is between the coast which is humid and received maritime winds (maritime Mediterranean climate), and the interior regions which are much dryer and experience hot breeze. (tempered / continental Mediterranean climate in the north and continental Mediterranean in the south)

The average solar insolation levels rise from the north to the south of Portugal, from a minimum of 1800h (per year) in the National Park Peneda-Gerês to a maximum of 3100h in Algarve’s southern coast. But the highest variation is felt in relation to the temperature from the pleasant coast to the huge thermal shift in the interior. On the other hand, precipitation diminishes from the north to the south and from the coast to interior. There is a maximum of 2800mm (of total quantity) in the National Park and a minimum of 400mm in southern coast. In the interior of the country, it generally rains less.

In the Alentejo region also, the coast and interior are characterised by different climates. In the interior, the hot and dry period lasts for about half the year. The dryness frequently affects agriculture in this area. Sometimes, there are heavy rains but the dry soil is not able to absorb the water fast enough before it evaporates or runs-off. Autumn is mild, but winter is cold with little rain (in general, less than 500mm), except in December, where it can reach 600mm. The coast is strongly influenced by the western Atlantic winds, which result in cooler summers and more moderate winter temperatures. Nevertheless, the average insolation is about 2900 hours. Rainfall is approximately 700mm.

In the north of this region, in Serra de São Mamede, winter is very cold (average 0°C) and summer is very hot (sometimes 40°C), and insolation hours are less (2700h) than in the region’s south (3000h). Rain is abundant (700mm) and the wind are stronger.

The vast and dry region of Alentejo, together with Andalusia in Spain is predicted to be the only region in Europe with the tendency to experience climate similar to to desert regions.”

.....

The above information was documented in 2000. Climate change has shown it effects since then.

As per the extreme temperatures recorded on the Portuguese Institute for Sea and Atmosphere’s (IPMA) website, the maximum temperature the country experienced was 47.4°C in Amareleja (Alentejo) in 2003. Then minimum temperature was -16°C in Penhas da Saúde in 1954. The highest amount of daily rainfall was recorded at 277mm in the archipelago of Madeira in 1976.

In recent years, Portugal has been experiencing heat-waves and wildfires. Some of these major fires include: 2016 (regions of northern Portugal and Madeira), 2017 (Castanheira de Pêra and Pedrógão Grande in Leiria), 2018 (near Portimão in Algarve). In the summer of 2018, the temperature in Alentejo hit almost 50°C.

Past records and future estimations with regards to climate change are depicted in graphs created by the AdaPT programme, which is meant to support adaptation to climate change in Portugal. Refer annexe for these statistics.

6.4. EARTHEN CONSTRUCTION TECHNIQUES IN PORTUGAL

“There is a wide variety of traditional construction techniques in Portugal, depending on the availability of natural materials in each region. Earthen constructions are significant to Portugal’s indigenous architecture, and three most commonly used techniques have been identified: rammed-earth, adobe-bricks and wattle-and-daub. More recently, a fourth technique was added: C.E.B. i.e. compressed earth block.

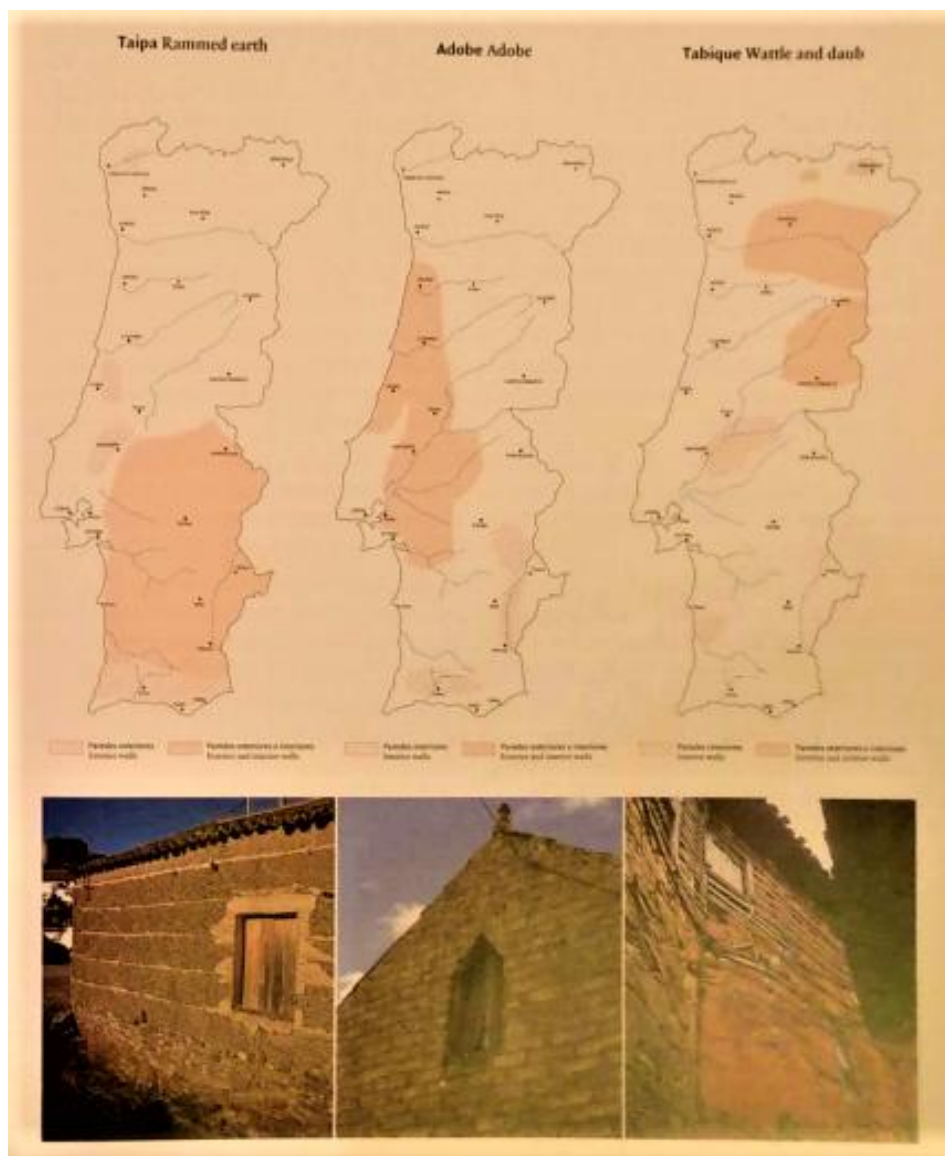

Image 147: Map showing the main traditional earth building techniques in Portugal.

[Source: Associação Centro da Terra. *Arquitetura de Terra em Portugal. Earth Architecture in Portugal*, p.21]

Up until the 1950s, in Southern Portugal, around the areas of Alentejo, Algarve and Ribatejo, the most commonly used construction technique was **rammed-earth**. These are walls constructed by using a ramming-tool to compact earth between two securely held wooden planks; the planks are later removed revealing the solid wall. The technique was mainly used in Baixa Alentejo, as well as in the south of Alto Alentejo, and can sometimes be found in parts of north Alto Alentejo. There are also rammed-earth references in the inland, central area of Alentejo i.e. in Castelo Branco. Due to rocky outcropping in some regions, stone masonry was used (especially schist masonry, as in the case of Monsaraz).

In addition to dwellings, there are windmills and granaries (*‘silos’* in Portuguese) with circular walls, which are clear examples that rammed-earth construction and its know-hows were well mastered and executed. Since the last few decades, this construction technique is making a come back in Alentejo and Algarve. Nevertheless, its diffusion is still limited.

The central region of Portugal’s coast is characterised by alluvial soils and is thus dominated by **adobe-brick** (sun-dried bricks) structures, especially near Aveiro, Coimbra, Bairrada, Leiria, Santarem, Coruche and Setúbal. This building technique is very common near alluvial zones, such as the Sado and Tagus valleys. Across Alentejo as well, there are many areas with clayey soil and adobe buildings (for example, the houses in the ancient Aldeia da Luz village). In these

places, sometimes the internal walls of rammed-earth constructions are built with adobe-bricks. In certain areas, adobe constructions were executed for historical and cultural reasons, such as in the case of the British engineers' house near the mine of São Domingos. This technique began to disappear in the 1960s and 1970s. In the last few decades however, some adobe-bricks houses have started to be built along the coast of Alentejo and Algarve.

A wide variety of adobe-brick typologies can be identified. For example, adobe-bricks composed of lime ('cal' in Portuguese) and sand had a better consistency, and were used to build water wells for agriculture and irrigation. Such wells can be found in Fermentelos, Águeda, etc.

The third widely used traditional earth construction technique in the country was **wattle-and-daub**. A structure of wood or reed was erected, and filled with earth and/or lime and sand mortar, and then covered with an earth or lime plaster. Sometimes, the exterior walls were protected with slate shingles, roof-tiles and corrugated metal. This was one of the first traditional earth construction techniques to disappear, though it still exists in the north and in the centre of the country, especially in the upper storey of houses built in stone masonry. It is also found as interior walls of some houses in Alentejo.

The north of Portugal used the '**taipa de fasquio**' technique; it belongs to the same family as wattle-and-daub. It consisted of an assemble of vertical wooden boards with planks nailed on the top diagonally, which formed a structure to which the horizontal laths ('*fasquio*' in Portuguese) were nailed onto. It was finally covered with earth and/or lime plaster. The taipa de fasquio was the most widely used technique in the historic centres of Porto and Guimarães. In Minho, there is a presence of the '**taipa de rodizio**' technique, which comprises a very flexible wooden structure, filled in with bricks, and earth or lime mortar.

The '**pombalino wall**' is a variant of the above mentioned techniques. This wall has its origin in the seismic resistant system of '*gaiola pombalina*' (pombalino cage), built after the 1755 earthquake in Lisbon. It was subsequently used all over the country.

In the end of the 1980s, the **C.E.B. i.e. 'compressed earth block'** technique was initiated in Portugal. This technique was invented in Colombia in the 1950s by Raul Ramez and had a huge repercussion at an international level. These earthen bricks are pressed and formed in a machine. The earth is required to be free from gravel and relatively humid, in order to allow adequate compression. Compressed earth constructions are concentrated in Algarve and some parts along the coast of Alentejo.

Finally, earth is used all over Portugal as mortars and plasters. Mortars are usually used in brick or adobe masonry walls. The mortar is composed of earth and sometimes a bit of lime. Similarly, earthen mortars were frequently used in the stone masonry, mainly in the north of the country. In the latter case, the mortar comprised a sandy earth with clay in it; it was called 'saibro'."

6.5. HISTORY OF EARTHEN CONSTRUCTIONS IN PORTUGAL

“Several authors have inferred that earthen constructions in the Iberian Peninsula was introduced by the Phoenicians, Carthaginians, Romans and Muslims. While all of them influenced Portugal’s earthen constructions, it was the Muslims who made a significant contribution. It is also well known that the use of earth in construction was practised since pre-historic times. Following is a summary containing archaeological references of earthen constructions dating to different periods of Portugal’s history:

NEOLITHIC

Estácio da Veiga, an Archaeologist identified an inhabitation in Paniachos, Quinta do Freixo (about 3km from Alte) with houses having a circular or ellipsoidal plan. Some foundations built in earth, and earthen mortar remain.

CALCOLITHIC (COPPER AGE)

Archeologists Joaquina Soares and Carlos Tavares da Silva conducted investigated a structure in Monte da Tumba near Torrão (Concelho de Alcácer do Sal). It dated to the Ancient Calcolithic period (2500BC). This circular shaped house was built with a stone base, adobe-brick walls, and formed domes.

IRON AGE

During the excavations in the Roman Forum of Alcácer do Sal, a team of archaeologists discovered some remains of a structure with a rectangular plan; it had stone foundations, adobe-brick walls, and compacted earthen floors. It dated to the first Iron Age.

Archaeologists Manuel Maia and Maria Garcia Pereira Maia found a circular structure near the Neves Corvo mines in the region of Castro Verde. It dated back to the second Iron Age (Turdetan period, parallel to the Tartessic one), and was built in stone and earth.

Also in Castro Verde, the second Estação Arqueológica Neves II (Archaeological Station Neves II) presents rectangular plan houses, with rammed-earth or adobe-brick walls, stone foundations and mortar with stones. The roofs have a single slope, wooden frame and thatch, and are sometimes covered with earthen mortar.

Mário Varela Gomes and A. da Silva also identified houses with a rectangular plan in Castro Verde and Ourique. They described that the main, central room has a fireplace and two other rooms (a bedroom and storeroom). There are niches and stone benches, and earth on walls.

CELTICS

Soares de Azevedo made references to an adobe tomb discovered in 1743 near the church in Alvito. It is likely that the tomb dates back to the Celtic period.

ROMANS

Pliny the Elder, in his 37 books on Natural History, described the existence of towers and very old houses built in earth in the Iberia Peninsula.

MUSLIMS (IBERIA PENINSULA INVASION IN 711)

The periods of Muslim influence include the Ommiad period (10th Century), Taifa’s Kingdom (11th Century), Almoravids (1030-1147), and Almoads (1147-1269). It was during this time that earthen constructions had a major influence.

A distinct house typology which was identified in an excavation made in the old villages of Al-Ândulas (Silves, Saltés, Pechina, Ciesa, etc.). The exterior walls of the base-course were built with stone, and above it were rammed-earth walls of 50cm thickness. In certain cases, there were narrow adobe-brick walls (20cm) on the interior.

Among the remains left by the Muslims, the most notable one is the fortresses built in stone or military rammed-earth. This technique survives even today in some Albarrãs towers or stone walls in Lisboa, Santarém, Elvas, Moura, Serpa, Mértola, Elvas, Castelo das Relíquias, Silves, Estômbar, Alvor, Castelo Belinho, Noudar, Aljezur, Cacela, Tavira, and Loulé as well as in some isolated fortresses in Algarve and Alentejo (e.g. Paderne, Salir, Alcácer do Sal, Juromenha).

AFTER THE RECONQUEST (1249)

The earthen structures that remain today are mainly rural houses. There are some in the city centres, many of which were destroyed in the 1755 Lisbon earthquake. These buildings in Lisbon had a wooden support at the core, and were covered with earth; they were about six floors high. After the earthquake, the same technique was adapted to include anti-seismic qualities. The revised technique was called ‘pombalino wall’.

PORTUGUESE EXPANSION

There are records from the 15th Century that state that one of the Gambian kings asked for two men who knew how to build rammed-earth houses and fortification walls for the village.

In 1571, in a donation letter from the Captain of Angola to the Governor, there are references of sending eight masons, four ditch diggers and six rammed-earth masons to construct in rammed-earth before the commencement of the construction of the fortress itself.

There are also references to Goa in India, where rammed-earth was used to build modest houses in Old Goa. In Goa’s local language, Konkani, the term ‘taip’ refers to rammed-earth, which is likely to have been borrowed from the Portuguese language. The term ‘taipa,’ as used in Portugal, and ‘tapia,’ as used in Spain, traces its origin to the Arabic word, ‘tabiya’.^{[283][284]}

In Brazil, the use of the term ‘pilão’ made it easier to transmit the know-hows of the rammed-earth technique to the native population; the technique is well-known in Olinda. In 1537, the Governor General of Brazil, Tomé de Sousa publicly supported the rammed-earth technique.”



Image 148 and Image 149: Rammed-earth fortification walls. Castelo de Mourão, Évora, Alentejo, 2018.



Image 150 and Image 151: Rammed-earth compound wall. Beja, Alentejo, 2018.

²⁸³ Jaquin, “Analysis of Historic rammed Earth Construction,” p.338

²⁸⁴ www.culture-terra incognita.org

6.6. RURAL ARCHITECTURE OF ALENTEJO

“The most commonly used construction materials and techniques until about 60 years ago were rammed-earth, adobe-brick, fired-brick, stone, lime, wood, reed and woadwaxen (*‘piorno’* in Portuguese).

The buildings were larger in their horizontal dimensions than those found in the north of the country. The building plan was generally rectangular in shape. In the rural countryside, structures consisted of a ground floor only. In the urban environment, there was often an upper floor.

For the most part, the facades had pure lines and massive shapes with few openings. The windows, if any, always had interior shutters, which protected the inside of the house from the intense heat of the sun. The main façade was likely to have a single door with an incorporated shutter or a door, and a window. From the facade, the large chimney was evidently seen, and so was the stone bench (*‘poial’* in Portuguese), which reinforced the walls. The architecture was well designed, and accentuated by several, successive layers of lime-wash. The buildings were white with the base-course and the surrounding of the openings outlined by a traditional blue colour (to keep the mosquito out) or green colour. Today, other colours such as yellow, pink and grey are also seen. It is also common to see women white washing walls during the summer, mainly at night.



Image 152: The traditional blue colour was later over-painted by reddish-pink shade. Beja, Alentejo, 2018.



Image 153: Painting base-courses and the frames of openings in traditional colours continues even today. However, today synthetic paints (*‘tinta’*), rather than pigments are used. Alcácer do Sal, Setúbal, Alentejo, 2018.

The typical rural house in Southern Alentejo often comprised a single compartment. At the entrance, which was the central part of the house, was the kitchen, which also served as a living-room. The alcoves faced this central space. The surrounding area of Évora is dominated by buildings that have massive volumes, complete with walls vaults and cupolas such as in the 'abóbadas' and 'abobadihas' styles; some of these had ribs (like in Portel). In this part of Alentejo, granite replaced schist in the construction of features (buttresses, corners, etc.) of the rammed-earth structures. The contrast of the granite with lime is much in evidence. The volume of the house continued to be greater along its horizontal dimension, but the plan had more compartments.

A noted characteristic of the vernacular architecture in Alentejo was the collective bread oven. It was either found in the annex built along the length of the house, or it was isolated some meters away; it was always crowned by a dome. On the other side of the annex was the animal shed.

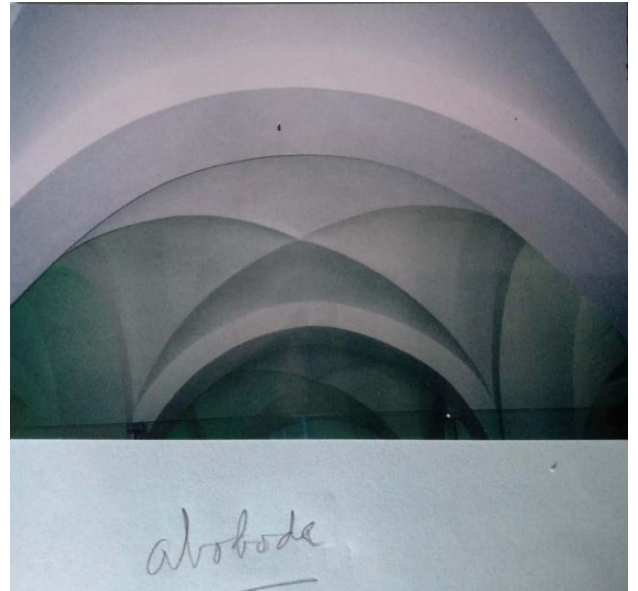
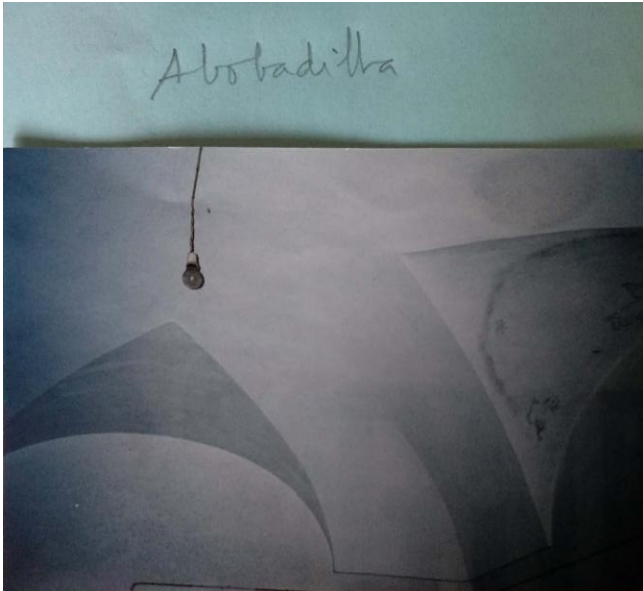

Image 154, Image 155, Image 156, Image 157, Image 158 and Image 159: Different types of vaults and cupolas.
 [Source: From the collection of Joaquim Antonio Baptista, Mason-Sailor, Mourão, Évora, Alentejo / Lisbon]

A noted characteristic of the vernacular architecture in Alentejo was the collective bread oven. It was either found in the annex built along the length of the house, or it was isolated some meters away; it was always crowned by a dome. On the other side of the annex was the animal shed.



Ovens, a characteristic feature of the rammed-earth houses of Alentejo.

Image 160: An oven built at one end of the house. Serpa, Beja, Alentejo, 2018.

Image 161 and Image 162: An oven built away from the house. Serpa, Beja, Alentejo, 2018.

The existence of huge buttresses (*'gigantes'*) reveals either the lack of foundations in the rammed-earth houses, or the existence of vaults and arches inside the house. In case foundations were built, the most commonly used material was the stone naturally found in the region (usually schist or granite, and sometimes fired-bricks). These materials were also used when building base-courses, corners and buttresses. Base-courses were frequently built 30cm-50cm higher than the house's interior pavement to avoid capillary rise.

The floors were made in compacted-earth or thin square mosaic bricks (*'baldosa'* in Portuguese), or in the areas with more footfalls (hall and kitchen) river rock was used.

The roofs had one or two low-pitched slopes and they were rarely hipped. They comprised of tiles that were placed directly on a simple wooden framework. Sometimes, there were wooden planks (*'guarda-pó'* in Portuguese), laths or reed between the roof-tiles and the wooden framework. The most commonly used tiles were the traditional 'canal' tiles. Some decades ago, those were replaced by mechanical 'Marseille' tiles called 'aba and canudo' in Portuguese. 'Canal' tiles were introduced in Portugal at the end of the 19th century and the 'aba and canudo' tiles in the second half of the 20th Century. Mechanical-tiles are much easier to fix, require less skill, and are much more economical. This is because one mechanical-tile can replace two or three traditional ones, depending on the tiles' dimensions.

Rammed-earth construction was the most commonly used technique in Central and Southern Alentejo, until the 1950s. Even in areas of Alentejo where there were more stones, especially granite or schist, rammed-earth constructions were dominant. In some houses, both stone and rammed-earth was found: rammed-earth walls with lime-and-stone-mortar, or rammed-earth in some parts and stone in others. In areas with lots of clay, adobe-bricks were used to build walls.



Image 163 and Image 164: A schist quarry. Near Mourão, Évora, Alentejo, 2018.

Rammed-earth was made between dis-mountable wooden boards, 2.00m in length and 0.5m in height. The wall's thickness could be adjusted as per choice; exterior walls were about 40cm-70cm and interior walls (in adobe-bricks or rammed-earth) were 10cm-30cm thick. The horizontal joints were simple and consisted of mortars made from lime, brick and/or stone. The joints that divided the rammed-earth bricks were vertical or diagonal.”

7. SURVEY — ALENTEJO

7.1. REGIONS SELECTED FOR STUDY

In Mariana's study ('Le Pise d'Alentejo' (2000); 'Taipa no Alentejo. Rammed Earth in Alentejo' (2007), 40 case-studies were realised. I revisited 23 of those buildings in 2018 for purpose of this study. As I was able to contact people in connection to 12 of the structures, 12 case-studies were updated.

The buildings that were revisited in 2018 were located in six municipalities, across three districts of Alentejo i.e. Évora, Beja and Setúbal.

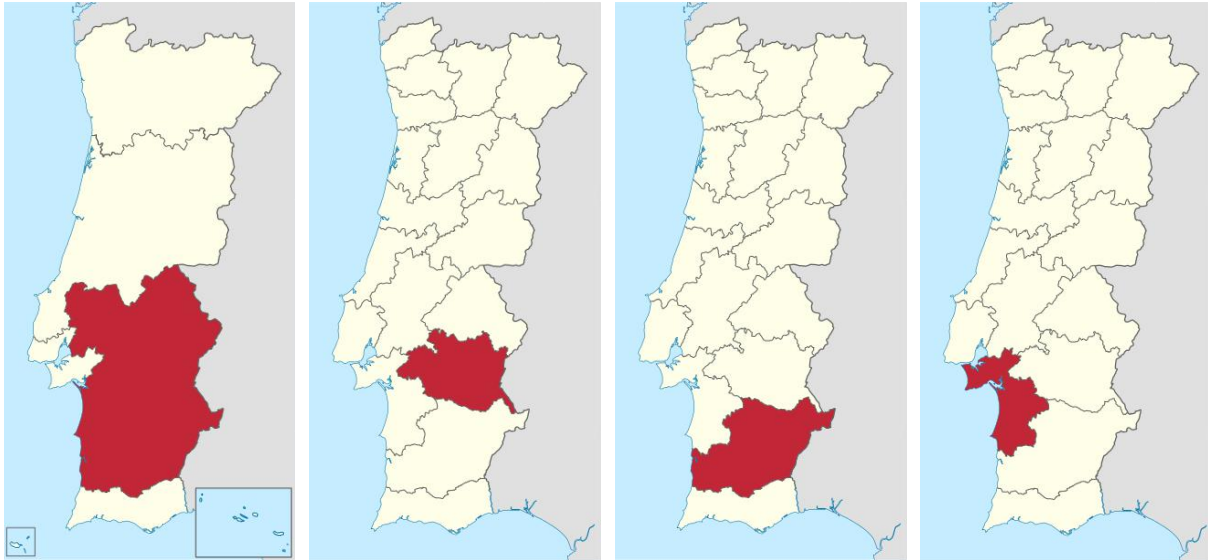

Image 165: Location of Alentejo in Portugal.

Image 166: Location of Évora district in Alentejo. Image 167: Beja district in Alentejo. Image 168: Setúbal district in Alentejo (and Lisbon).
[Source: Wikipedia]

- Buildings re-analysed in 2018:
 - The municipality of Reguengos de Monsaraz, Évora district: Survey nos. 1[1], 2[38].
 - Redondo, Évora: Survey nos. 3[9], 4[10], 5[11].
 - Mourão, Évora: Survey nos. 6[14], 7[39], 8[40].
 - Moura, Beja: Survey nos. 9[18], 10[19].
 - Serpa, Beja: Survey nos. 11[25], 12[27].
- Buildings photo documented in 2018:
 - Reguengos de Monsaraz, Évora: Survey nos. [2], [4], [5], [7], [8].
 - Redondo, Évora: Survey no. [13].
 - Moura, Beja: Survey nos. [20], [21].
 - Serpa, Beja: Survey no. [26].
 - Alcácer do Sal, Setúbal: Survey nos. [35], [37].

7.2. LOCATIONS OF BUILDINGS SURVEYED AND CASE-STUDIES

The case-studies were updated and revised by Chenelle Rodrigues based on the work of Mariana Correia ('Pise d'Alentejo', 2000; 'Taipa no Alentejo. Rammed Earth in Alentejo', 2007).



Image 169: Location of buildings surveyed in Alentejo.

[Source: Correia, *Le pise d'Alentejo, Portugal*, 2000] (Brown highlights indicate buildings surveyed for this study)

SURVEY NO. 1[1]

IDENTIFICATION

District: Évora.

Municipality: Reguengos de Monsaraz.

Parish: Monsaraz.

Nearest village: Telheiro.

Building name: 'Monte da Coutada'.

Owner(s): Maria Vicência Oliveira Patrício (78 years old, in 2018).

Address: "Monte da Coutada", Ferragudo — Monsaraz, 7200 Reguengos de Monsaraz.

Directions: Take the road towards Monsaraz. After Telheiro, follow the signpost pointing towards "Monte Alerta". "Monte da Coutada" is 200m towards the north.

Construction technique(s): Rammed-earth (referred to as 'taipa' in Portuguese) and adobe-bricks ('tijolo cru').

Visited on: 19/04/2000.

Revisited on: 08/09/2018.

BUILDING DATA

CHRONOLOGICAL DATA

Construction date: 1920.

Builder: Manuel Cabelinho who lives in Motrinos.

Original use: House + lean-to + warehouse.

Present use: House + warehouse.

History of the building: The present owner's aunt, Vicência Maria Oliveira asked a mason to build it.

The owners have two houses situated not far from each other. This house, 'Monte da Coutada' used to be inhabited regularly during the summer months; it is less frequented now. The building was mainly used to house animals and for other agricultural purposes. The corner room from which the smaller chimney emerges has an oven. The building was also used to make and sell firewood and coal, but is no longer used for these purposes.

Restorations and/or interventions: The annex was built with stone by a mason called Alfredo, in 1947.

Building in use or not: Still in use.

Building at risk: No.

Information given by: The owner. (When visited in 2000.)

Owner; and her son, Victor Gabriel Oliveira, 59 years. (When visited in 2018.)

Other important data: In this region, the most known masons were Manuel Cabelinho from Motrinos (passed-away), his son José Nique, and Joaquim Ferrao. 'Mestre Moco' also built with 'botano', which is a very thin dust. (Mason is referred to as 'pedreiro' in Portuguese.)

The owners also owned a quarry, which is no longer in use. It was situated where the 'São Lourenço Barrocal' hotel currently stands. Speaking from childhood memories, the last rammed-earth house that Maria remembers being built was the one that she grew up in, 'Monte Colorao Ribeiro'; it was in 1944-45. The first cement-blocks ('blocos' in Portuguese) structure was built about 70 years ago. She adds that in recent years, quite a few rammed-earth buildings have been constructed in the region, such as the one at Esporão winery.

Perspectives of the building



Earth used & Typology



(Source: Correia, Le Pise d'Alentejo, Portuagal, 2000)



(Source: Correia, Le Pise d'Alentejo, Portuagal, 2000)



(Source: Correia, Le Pise d'Alentejo, Portuagal, 2000)

TECHNICAL DATA

Base-course: 2m outside and 1.75m inside; in schist masonry.

Flooring: The flooring is in compacted-earth in the annexes, slate and clay 'baldosa' tiles. (thin squared stone, typical from Alentejo) in the kitchen and bedroom respectively. (Stones were commonly used as floor tiles in the kitchen because they are easy to clean.)

Buttresses: None.

Corners: In rammed-earth.

Openings: Four doors and one window.

Roof type: 'Canal' and 'aba e canudo' tiles.

Thickness of exterior wall: 50cm.

Distinct architectural details: The chimney.

Observations:

TYPOLOGICAL DATA (rammed-earth / cob)

Description of earth used: Mainly schist and clay.

Dimensions of the rammed-earth block: 2.50m (length) x 50cm (height).

Mortars: None.

Plasters, pigments and/or paints: Plaster and whitewash only on main facade (exterior). All interior walls of the habitation area — but not the annexes — are plastered (interior).

Distinct characteristics: In this region, 'talisca' was added to the rammed-earth mixture. The inside walls are in adobe. Size of the adobe-bricks: 30cm (length) x 20cm (width) x 10cm (height).

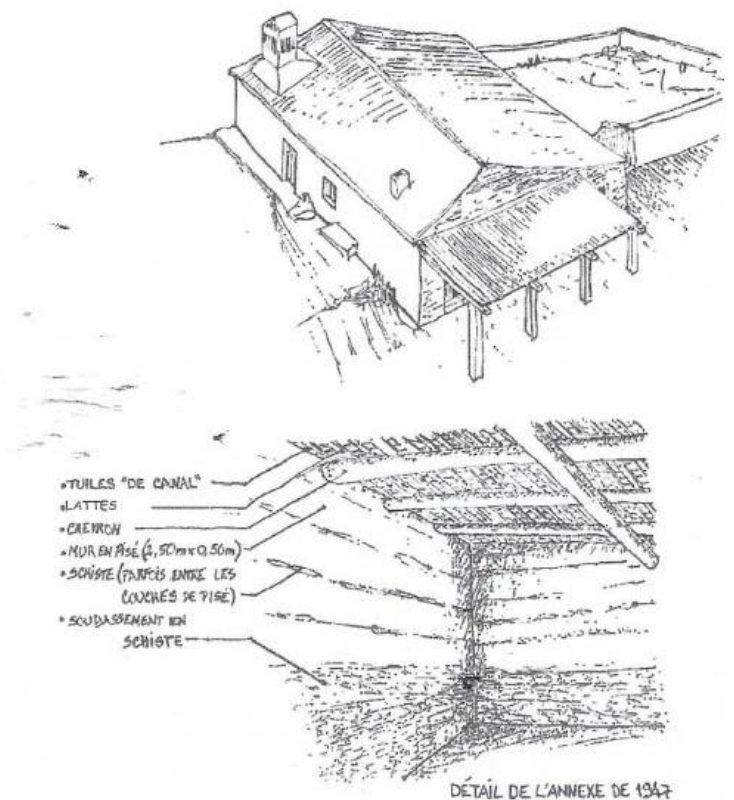
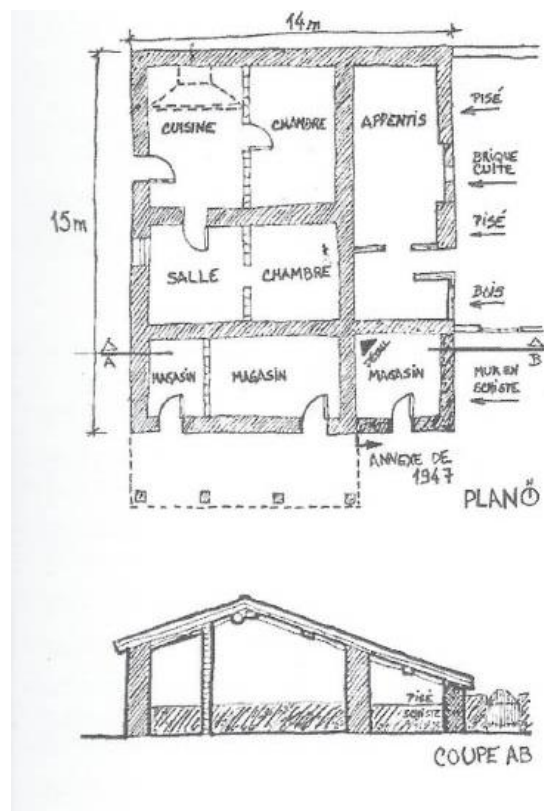

[Source: Correia, *Le pise d'Alentejo, Portugal*, 2000]



Oven inside the house.



Distinct characteristics: Interior walls are in adobe-bricks.



Flooring: Stones were commonly used as floor tiles in the kitchen because they are easy to clean.



Flooring: Stones used for flooring is naturally found in the region.

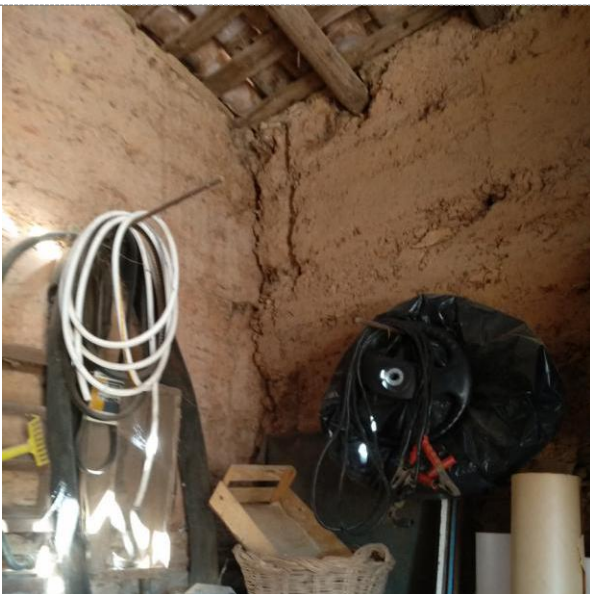

Damages incurred / problems faced: Cracks in corners.

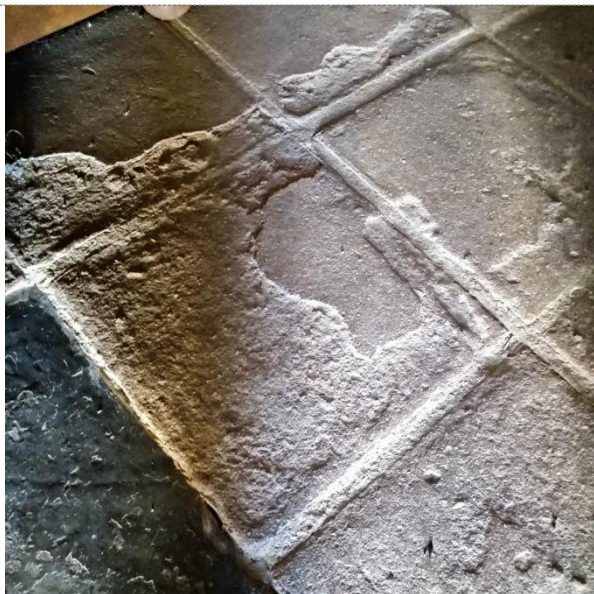

Damages incurred / problems faced: Clay 'baldosa' floor-tiles are chipped-off in some places.

CARE AND CONTINUITY

CONDITION ASSESSMENT

Damages incurred / problems faced:

Cracks appeared sometimes on walls, and very rarely on plasters.

Observations: Cracks in corners, clay 'baldosa' floor-tiles chipped-off in some places.

MAINTENANCE AND REPAIRS

Preventive conservation:

Periodic interventions: The roof needed to be cleaned once in a while, especially to remove plants, moss, etc. that grew on it. Cleaning was usually done with a brush. Before, walls were whitewashed with lime ('cal' in Portuguese) every 1-2 years. For the last 16 years however, this has not been done. Instead, about 10 years ago, white paint ('tinta' in Portuguese) was applied on the interior walls only. The wives and daughters of the family would do the whitewashing.

Repairs: In the 1980s, the roof was redone because the wood had rotted. At the same time, part of the roof was fitted with new tiles. For cracks, sand (3 portions) + lime (1 portion) were mixed in a bucket and used to fill-up cracks. The last crack was repaired about 30 years ago. There has been no need of repairs since then.

Observations: Cement used to raise walls. Floor and walls touched-up with cement.

Other information: Traditionally, black-lime (referred to as '*cal preta*', '*cal parda*', '*cal de obra*' or '*cal morena*' depending on the region) was used on buildings, but Victor does not remember using this type lime to whitewash his house. In order to make lime, burnt stones were bought from the marble quarries of Bencatel, about 30-40kms from Monsaraz, or from hardware shops in Monsaraz. Whitewashing was usually done by women, and repair work by masons.

Challenges faced today:

Future plans: No.

MAJOR CHANGES SINCE 2000

The roof of the lean-to has fallen. The wooden part of the east wall is now covered with panels and shutters.

In 2000



[Source: Correia, Le pise d'Alentejo, Portugal, 2000]



[Source: Correia, Le pise d'Alentejo, Portugal, 2000]

In 2018



SURVEY NO. 2[38]

IDENTIFICATION

District: Évora.

Municipality: Reguengos de Monsaraz.

Parish: São Pedro do Corval.

Nearest village: São Pedro do Corval.

Building name: 'Olaria: O Patalim'.

Owner(s): José Joaquim dos Santos.

Address: 'Olaria: O Patalim', São Pedro do Corval — 7200 Reguengos de Monsaraz.

Directions: As you leave Reguengos de Monsaraz, take the road towards Monsaraz. As you pass through the village of São Pedro do Corval, 'Olaria: O Patalim' is on the right at the junction of 'Rua Prof. Cândido'. A big gate leads you to 'Olaria: O Patalim'.

Construction technique(s):
Rammed-earth i.e. 'taipa'.

Visited on: 27/04/2000.

Revisited on: 09/09/1018.

BUILDING DATA

CHRONOLOGICAL DATA

Construction date: 1927.

Builder: Unknown.

Original use: For pottery + workers' quarters.

Present use: For pottery.

History of the building: The owner's father-in-law constructed this building 75 years ago to replace an older rammed-earth building, which was also used by the family to produce pottery. (Documented in 2000.)

The family has been into the pottery business for generations; they have pottery business registration papers that date to about 200 years ago.

Restorations and/or interventions: 25 years ago, the height of the building was slightly raised, and the wooden roof beams were replaced with steel ones. (Documented in 2000.)

About 6 years ago, a few more changes were made:

1. The roof-line was raised again. The rafters were made from eucalyptus and the batons from pine wood. A few months later, the room adjoining the rammed-earth wall, which still had its original roof, caught fire and had to be redone.
2. The smaller rooms of the buildings were previously used as workers' quarters and were last inhabited by a worker's family. They are converted into an atelier. For this, the chimney was broken in order to widen the doorway between the shop (the biggest room) and the atelier.
3. A part of the interior wall of the shop, where the clay is moulded with water was plastered with cement with the purpose of water-proofing the wall. (Documented in 2018.)

Building in use or not: Still in use.

Building at risk: No.

Information given by: Teófilo dos Santos, owner's son. (When visited in 2000.)

Nelia do Santos, owner's grand-daughter, 43 years old. (When visited in 2018.)

Other important data: The building comprises three parts, built during different periods. The biggest part (west side) is the oldest. In 1998, an oven from the Roman period was discovered on the right side of the entrance gate, when reconstructing a pre-existing building. The oven was made of clay bricks. It no longer exists. The São Pedro do Corval village is the biggest pottery centre of the country. The soil around the village is generally very clayey.

A mason from the village called Juze Mendes, about 80-90 years of age, made 'Abobadilha' and 'Aboboda' vaults. He now lives in Montemor (?). Nelia does not remember any rammed-earth building being built in her lifetime.

Perspectives of the building



Earth used & Typology



[Source: Correia, Le pise d'Alentejo, Portugal, 2000]



[Source: Correia, Le pise d'Alentejo, Portugal, 2000]

TECHNICAL DATA

Base-course: 1m; in fired-brick or stone masonry.

Flooring: Clay tiles in the shop area.

Buttresses: None.

Corners: In rammed-earth.

Openings: Five doors and five windows.

Roof type: 'Canal' tiles.

Thickness of exterior wall: 50cm (without plaster).

Distinct architectural details: Steel beams in a rammed-earth building. (Documented in 2000.)

Observations:

TYPOLOGICAL DATA (rammed-earth / cob)

Description of earth used: Clayey earth with sand and lime.

Dimensions of the rammed-earth block: 1.56m x 50cm (sometimes there is one layer of rammed-earth in each form-work, sometimes two layers). (A layer of earth in earthen constructions is referred to as a 'lift'; in this context, if layers exist within a 'lift' they are often simply called 'layers'.)

Mortars: 4cm of lime mortar along horizontal joints, below the bricks.

Plasters, pigments and/or paints: Lime plaster with blue wall-base (exterior); no plaster (interior). (In 2000.)

Main facade wall repainted in the same colours. The other wall is coloured in white, blue and yellow vertical lines. (In 2018.)

Distinct characteristics: Between each rammed-earth 'lift', there is mortar and fired-bricks. The brick-layers differ in sizes depending on the bricks' dimensions: 35cm (length) x 17cm (width) x 7cm (height) or 31.5cm (length) x 16cm (width) x 4cm (height).

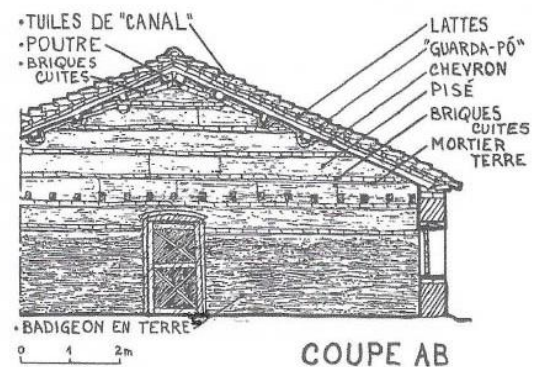
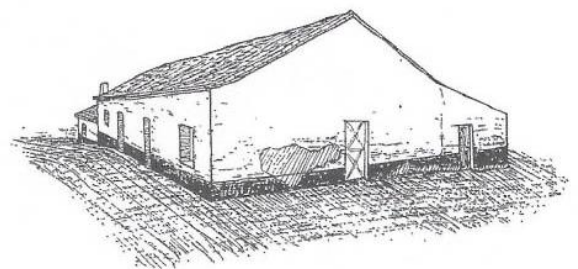
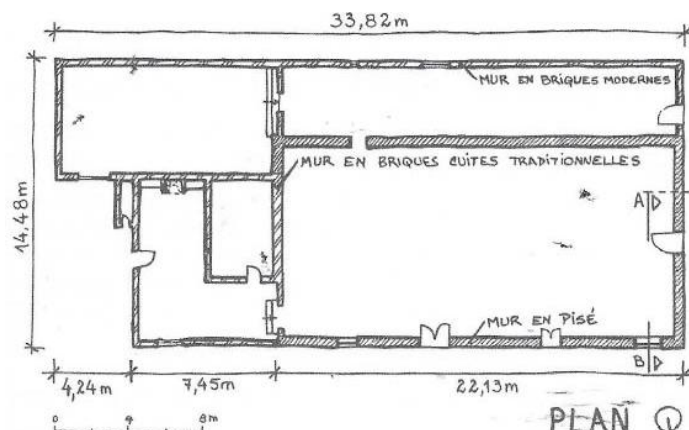

[Source: Correia, *Le pise d'Alentejo, Portugal*, 2000]



Interior views.



Base-course: Stone masonry.

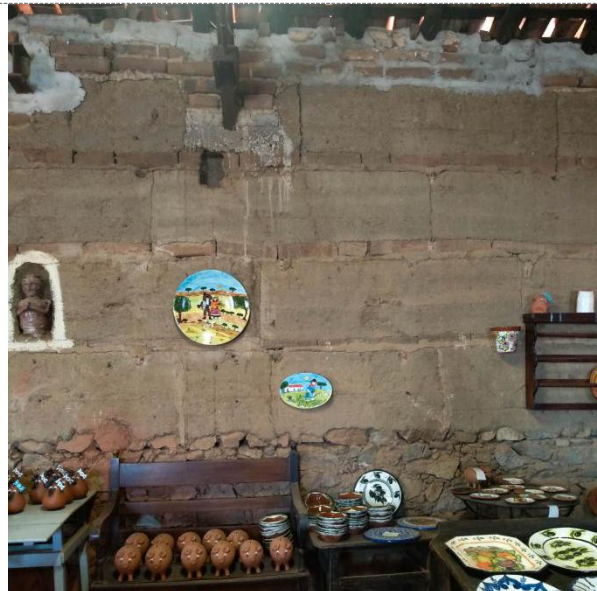

Distinct characteristics: Between each rammed-earth 'lift', there is mortar and fired-bricks. The brick-layers differ in sizes depending on the bricks' dimensions.

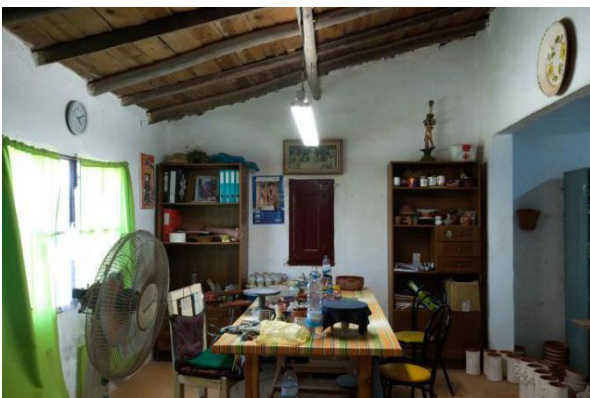

Restorations and/or interventions: The old workers' quarters is converted into an atelier.

CARE AND CONTINUITY

CONDITION ASSESSMENT

Damages incurred / problems faced: Part of the roof caught fire.

Observations: Cracks on walls, some floor-tiles chipped-off.

CONSERVATION

Preventive conservation: When redoing the roof seven years ago, burnt oil from car engines was applied to the eucalyptus rafters. This is usually a one-time treatment for roofs.

Periodic interventions: The external walls are repainted in white every year and masons are hired for the same. Earlier lime was used and now paint is used. The last time lime was used on this building was 10 years ago. That year, Nelia's father's brother did the whitewashing because masons no longer wanted to use lime. The most recent repainting was in June, just a couple of months back. (Also refer 'Challenges faced today' section.)

Repairs: Roof that caught fire was redone.

Observations: Cement is used to raise and fix walls.

Other information:

Challenges faced today: It is too cold in the building during the winters and too hot during the summers.

Winds cause the tiles to shift out of place, and sometimes even fly-off the building. Old tiles are sometimes so fragile that even a cat walking on wet tiles during the rainy season could cause them to break. The roof thus needs to be reworked on at least twice a year i.e. before and after the monsoons in October and May respectively. It needs cleaning, realigning of retainer hooks and tiles, and replacing of broken tiles. Masons have to be hired for this work.

Future plans: Will be continued to be used as a commercial space for pottery.

MAJOR CHANGES SINCE 2000

Roof replaced, workers' quarters converted into an atelier, chimney torn-down and east gable wall partly reconstructed, facade walls repainted in white, blue and yellow.

In 2000



(Source: Correia, Le pise d'Alentejo, Portugal, 2000)



(Source: Correia, Le pise d'Alentejo, Portugal, 2000)

In 2018



SURVEY NO. 3[9]

IDENTIFICATION

District: Évora.

Municipality: Redondo.

Parish: Montoito.

Nearest village: Aldeias de Montoito.

Building name: 'Adega do Monte das Castilhas'.

Owner(s): Augusto Gustavo.

Address: 'Adega do Monte das Castilhas', Aldeias de Montoito — 7200-051 Aldeias de Montoito.

Directions: As you arrive via Falcoeiras or Montoito, follow directions to Santiago Maior. As you reach Aldeias de Montoito, which is en route, turn right towards 'Monte das Castilhas' and continue along the dirt-road. The building is on the right side.

Construction technique(s):
Rammed-earth i.e. 'taipa'.

Visited on: 19/04/2000.

Revisited on: 23/09/2018.

BUILDING DATA

CHRONOLOGICAL DATA

Construction date: 19th Century (+120 years). (Calculated in 2000.)

Builder: 'Xico Velhaco'.

Original use: Cellar and winery.

Present use: Abandoned.

History of the building: The owner's great-grandfather asked a rammed-earth builder to build it. (Documented in 2000.)

Florbella, who shared the information for this case-study related that she has never seen the building in use in her lifetime. She however remembers that years ago, the roof was still standing, there were big wine pots inside, and the well next to the building had water. About 30 years ago, they took the jars and left the doors open. After that, the roof began collapsing and fell. About 10 years ago, the building was already in a ruined state. (Documented in 2018.)

Restorations and/or interventions: The buttresses were added later.

Building in use or not: Discontinued to be used about 25 years ago. (As calculated in 2000.)

Building at risk: Yes, the structure of the roof is in ruins and will fall down soon. (Documented in 2000.)

Yes, the structure of the roof has fallen and the building is in a dilapidated state. (Documented in 2018.)

Information given by: José António Mónica (neighbour) and Manuel Joaquim Esteves (who used to help the rammed-earth builder, Francisco Rebita). (When visited in 2000.)

Florbella Fernandes, daughter of the previous owner of the house next door i.e. daughter of Joaquim António Madeira, former owner of 'Monte das Castilhas'. She works at the Biblioteca Municipal de Redondo. (When visited in 2018.)

Other important data: The building never had water or electricity connection. The rammed-earth builders from this region were Francisco Rebita, João Chical, José Madeira, Francisco Madeira Angelico (better known by his nickname, 'Xico Velhaco') and his son Joaquim Madeira (both passed-away). Xico Velhaco's grandson is also a mason, but he never built rammed-earth.

Perspectives of the building

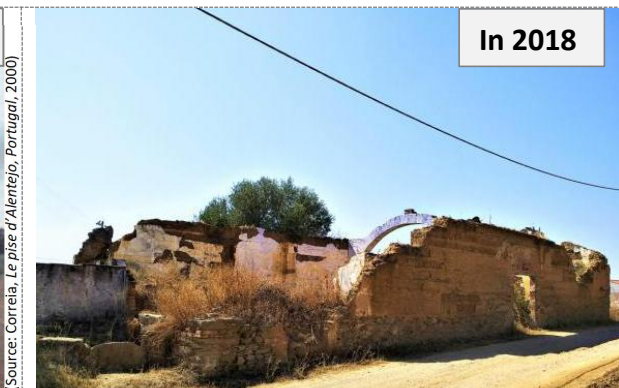
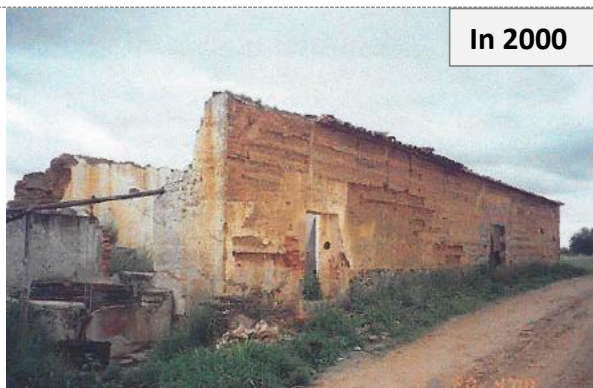

Earth used & Typology



TECHNICAL DATA

Base-course: 70cm; in schist and granite masonry.

Flooring:

Buttresses: In granite, fired-brick, and earth-mortar.

Corners: In bricks.

Openings: Two doors and one window (added later).

Roof type: 'Canal' tiles.

Thickness of exterior wall: 54cm (without plaster).

Distinct architectural details: Arches on the interior.

Observations: Fired-bricks are used along the door frame.

TYPOLICAL DATA (rammed-earth / cob)

Description of earth used: Contains high quartz composition.

Dimensions of the rammed-earth block: 1.47m x 50cm (two layers of rammed-earth in each form-work).

Mortars: Vertical joints have 1-1.5cm of earth-mortar. Horizontal joints have 2-4cm of earth-mortar between the rammed-earth 'lifts' and the fired-brick layers. Size of bricks: 30cm x 7cm x 17cm.

Plasters, pigments and/or paints: The east and west facades have a lime-plaster, and the north and south facades have an earth-plaster (exterior). Interior walls plastered (interior). (In 2000.)

Blue daubs or design on interior plaster, visible on arches. (In 2018.)

Distinct characteristics: Each block has two rammed-earth 'lifts'.

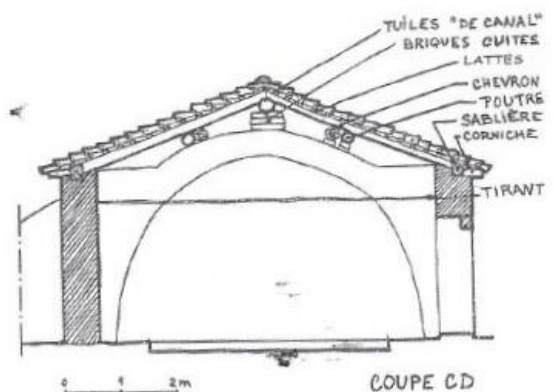
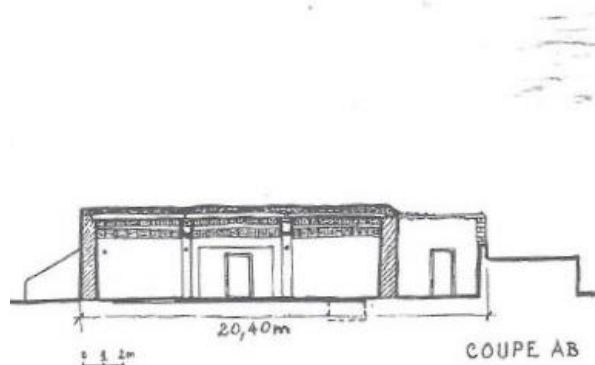
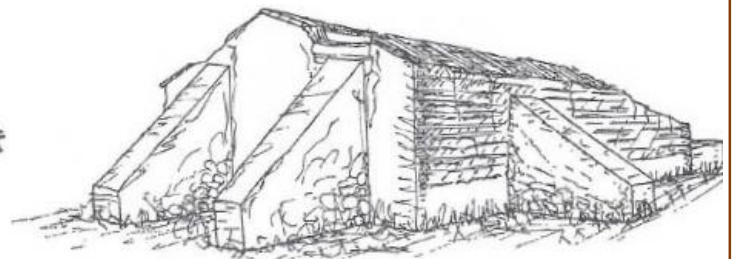
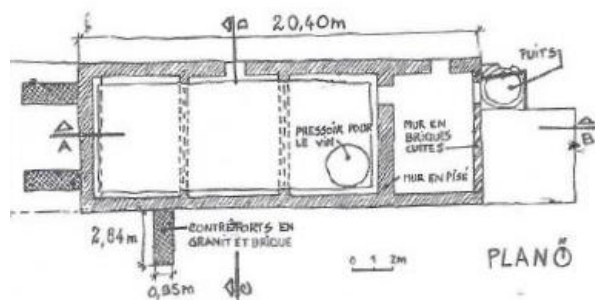

[Source: Correia, *Le pise d'Alentejo, Portugal*, 2000]



South view.



Base-course: In schist and granite masonry.
Use of fired-bricks along door frame.



Distinct architectural details: Arches on the interior.
Maintenance and repairs: Ties between arches.



Distinct architectural details: Arches on the interior.



Damages incurred / problems faced: Mason-bee holes.

CARE AND CONTINUITY

CONDITION ASSESSMENT

Damages incurred / problems faced:

Observations: Walls and roof in ruins, cracks on walls, falling plasters, mason-bee holes, damaged fire-bricks (probably not part of the original construction), vegetation in and around the building.

MAINTENANCE AND REPAIRS

Preventive conservation:

Periodic interventions:

Repairs:

Observations: Ties between arches.

Other information:

Challenges faced today:

Future plans:

MAJOR CHANGES SINCE 2000

Roof has collapsed; walls in ruins; blue daubs or design on interior plaster, especially on arches.

In 2000



(Source: Correia, Le pisé d'Alentejo, Portugal, 2000)



(Source: Correia, Le pisé d'Alentejo, Portugal, 2000)

In 2018



SURVEY NO. 4[10]

IDENTIFICATION

District: Évora.

Municipality: Redondo.

Parish: Montoito.

Nearest village: Aldeias de Montoito.

Building name: 'Monte das Castilhas'.

Owner(s): Joaquim António Madeira. (Documented in 2000.)

Current owners live in Lisbon. (Documented in 2018.)

Address: 'Monte de Castilhas', Castilhos de Cima, Aldeias de Montoito — 7200-051 Aldeias de Montoito.

Directions: As you arrive via Falcoeiras or Montoito, follow directions to Santiago Maior as Aldeias. When you reach Aldeias de Montoito, which is en route, turn right towards 'Monte das Castilhas' and continue along the dirt-road. The building is on the left side.

Construction Technique(s):
Rammed-earth i.e. 'taipa'.

Visited on: 19/04/2000.

Revisited on: 23/09/2018.

BUILDING DATA

CHRONOLOGICAL DATA

Construction date: 19th Century (+130 years). (Calculated in 2000.)

Builder: Unknown.

Original use: House.

Present use: House. (Documented in 2000.)

Abandoned. (Documented in 2018.)

History of the building: The building was constructed by the previous owner's grandfather i.e. the owner before Joaquim António Madeira. His father was born in this building 96 years ago. (Documented in 2000.)

This house and the houses around were originally occupied by families that were related to each other. About 30 years ago, Joaquim António Madeira bought the house. He used it to keep farm machinery and for other agricultural purposes. About 20 years ago, one of Mr. Joaquim's farm workers lived in the house along with his family. They ran away about 10 years ago. Gypsies would occupy the house off and on without seeking permission, and the house got into a bad shape. Mr. Joaquim's son broke down one of the rammed-earth walls along the south side in order to keep the gypsies away. Joaquim sold the house about 3-4 years back.

Restorations and/or interventions: There were annexes added all along the years (see the plan):

1. Original building, oldest part.
2. Part of the building was destroyed some years ago.
3. First annexe: Rammed-earth construction. (Different from the original part.)
4. Second annexe: Fired-brick construction. The earth consists of the same composition as the previous rammed-earth construction (earth and quartz).
5. Third annexe: Wood, cast-iron roof.

Recently, a cement coat was added in some parts of the building. (Documented in 2000.)

Many alterations were made to the building after the worker's family moved in. The second annexe (no. 4) was used as a kitchen. A bathroom was accommodated in the building though there was no running water; they used a nearby fountain or well. There is a brick wall constructed along the east facade, extending northwards.

Building in use or not: Still in use. (Documented in 2000.)

Not in use for the last 10 years approximately. (Documented in 2018.)

Building at risk: No. (Documented in 2000.)

Yes. (Documented in 2018.)

Information given by: José António Mónica, a former owner. (When visited in 2000.)

Florbella Fernandes, daughter of the previous owner, Joaquim António Madeira. She works at the Biblioteca Municipal de Redondo. (When visited in 2018.)

Other important data: Access to the inside house of the house was not possible as the owner was not present. (Documented in 2000.)

The house is in ruins, some parts are accessible. (Documented in 2018.)

Perspectives of the building



Earth used & Typology
(original building)



TECHNICAL DATA

Base course: 80cm; in schist, granite, marble and brick masonry.

Flooring:

Buttresses: None.

Corners: In stone (schist and granite) and brick.

Openings: A door with an incorporated window and shutter.

Roof type: 'Canal' tiles and cast-iron sheets.

Thickness of exterior wall: Main building: 47cm. First annexe: 57cm. (Both without plaster.)

Distinct architectural details: No.

Observations:

TYPOLOGICAL DATA (rammed-earth / cob)

Description of earth used: Main building (no. 1) — Fine soil particles, includes small quantities of quartz, schist and tile pieces. First annexe (no. 3) — Fine soil particles, includes small quantities of quartz.

Dimensions of the rammed-earth block: Main building: 1.50m x 45cm (two layers). First annexe: 1.50m x 45cm (one layer).

Mortars: In the original rammed-earth part, sometimes there is a little earth-mortar between the brick rows.

Plasters, pigments and/or paints: Lime plaster, a coat of yellow on walls or wall-bases. The east facade of the original building is an exception; it has an earthen-plaster. (In 2000.)

Wall-base and door frame is repainted in blue. (In 2018.)

Distinct characteristics: The rammed-earth typologies in the original building and the first annexe are very different. Both types were identified in Aldeias de Montoito village. There is an earthen dividing wall, probably in adobe-bricks in the original building.

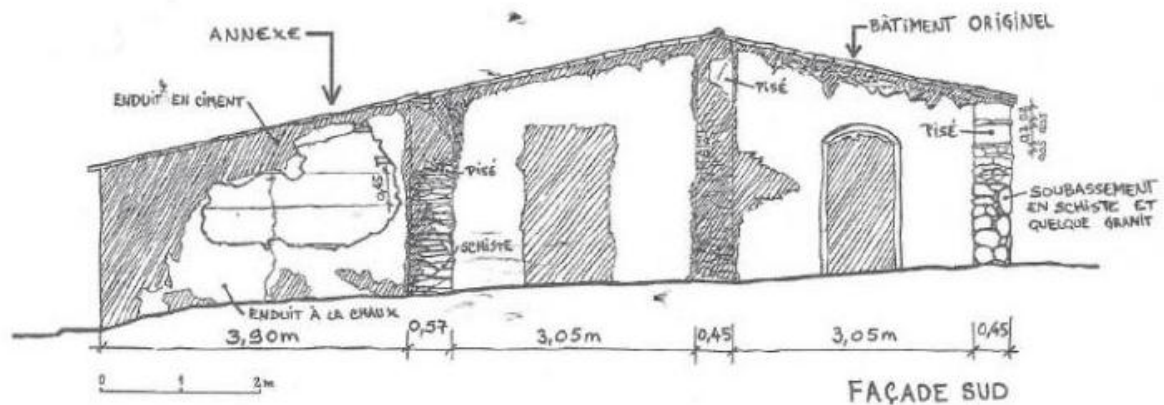
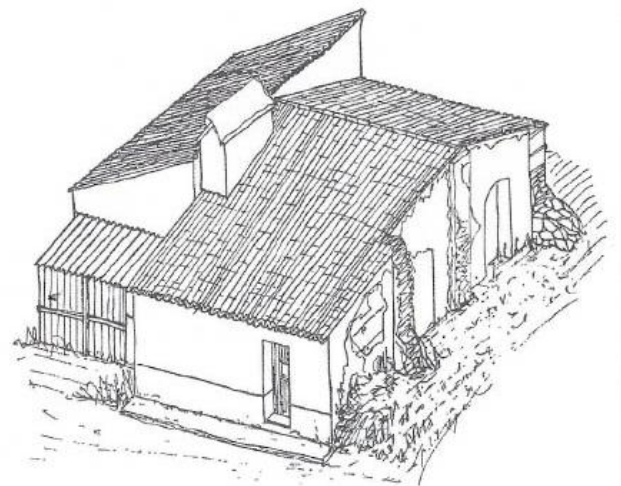
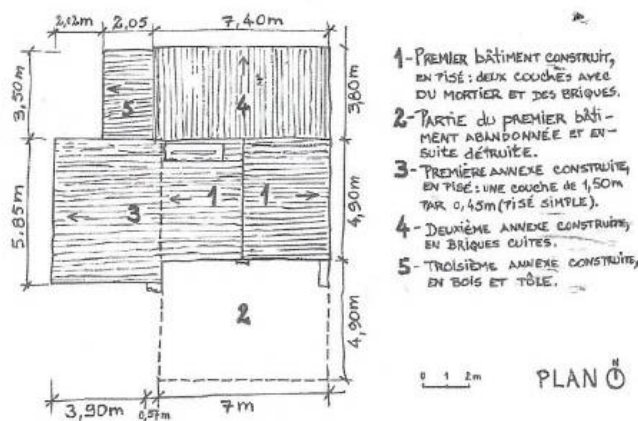

[Source: Correia, *Le pise d'Alentejo, Portugal*, 2000]



(Source: Correia, Le pise d'Alentejo, Portugal, 2000)

Earth used, first annexe.



(Source: Correia, Le pise d'Alentejo, Portugal, 2000)

Typology, first annexe.



Distinct characteristics: There is an dividing wall, probably in adobe-bricks in the original building.



Damages incurred / problems faced: The house is in ruins, and there is vegetation inside and around it.



Damages incurred / problems faced: Cracks appeared and the walls began falling apart.

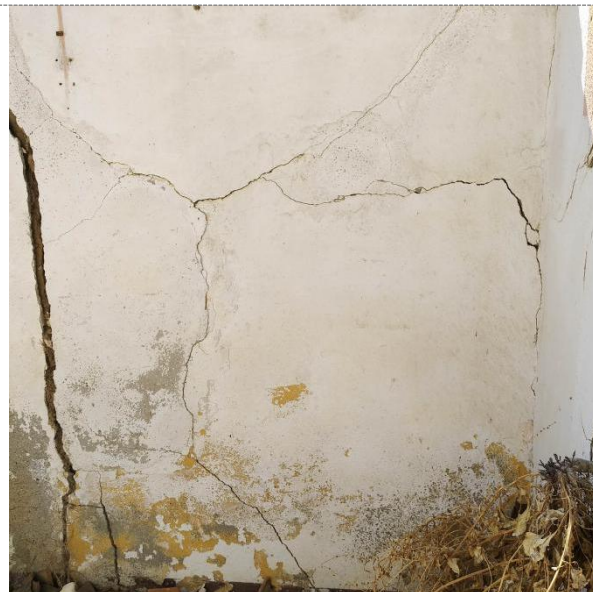

CARE AND CONTINUITY

CONDITION ASSESSMENT

Damages incurred / problems faced:

The house was poorly maintained and hence was not in the best condition when Joaquim bought it. There were problems mainly with the walls because they were exposed. There were cracks and the walls began falling apart.

Observations: As the house is now in ruins, there is vegetation inside and around the house.

MAINTENANCE AND REPAIRS

Preventive conservation:

Periodic interventions:

Repairs: The walls were coated with lime. Yellow water-based paint (referred to as 'tinta da agua' in Portuguese) was used on walls. The worker's family did it themselves.

Observations:

Other information:

Challenges faced today:

Future plans:

MAJOR CHANGES SINCE 2000

The house is in ruins. The chimney and roof have fallen, walls are cracked and broken, there are debris and abandoned cars around the house. Wall extended in brick along east facade. Wall-bases repainted in blue (records from 2000 show yellow), door border also painted.

In 2000



(Source: Correia, Le pise d'Alentejo, Portugal, 2000)



(Source: Correia, Le pise d'Alentejo, Portugal, 2000)

In 2018



SURVEY NO. 5[11]

IDENTIFICATION

District: Évora.

Municipality: Redondo.

Parish: Montoito.

Nearest village: Aldeias de Montoito.

Building name: 'Monte da Azinheira'.

Owner(s): Francisco Apolónio Marcão. (Documented in 2000.)

Paulo Manuel Pereira Sousa. (Documented in 2018.)

Address: 'Monte da Azinheira', Castilhos de Cima, Aldeias de Montoito — 7200-051 Aldeias de Montoito.

Directions: As you arrive via Falcoeiras or Montoito, follow directions to Santiago Maior as Aldeias. As you reach Aldeias de Montoito, which is en route, turn right towards 'Monte das Castilhas' and continue along the dirt-road. After the ruin, turn right. The building is the second one on the left side.

Construction Technique(s): Rammed-earth i.e. 'taipa'.

Visited on: 20/04/2000.

Revisited on: 23/09/2018.

BUILDING DATA

CHRONOLOGICAL DATA

Construction date: 19th Century (+130 years). (Calculated in 2000.)

Builder: Joaquim Madeira.

Original use: Warehouse.

Present use: Warehouse. (Documented in 2000.)
House. (Documented in 2018.)

History of the building: Francisco Apolónio Marcão's (former owner) godfather, Francisco Polónio asked a rammed-earth builder to build it. (Documented in 2000.)

The house was previously occupied by the former owner's father-in-law. It is currently occupied by tenants. (Documented in 2018.)

Restorations and/or interventions: 45 years ago, the former owner built the annexe with cement blocks. Through the years, other materials such as fired-brick and concrete were added. Recently, a cement coat was put in several parts of the original building. (Documented in 2000.)

A new compound wall is constructed and the position of the entrance gate is shifted. The chimney is no longer there. The extension has its roof lowered, its door on the east wall is closed with cement blocks, and the north wall is torn down to form an opening. (Documented in 2018.)

Building in use or not: Still in use.

Building at risk: No.

Information given by: Former owner. (When visited in 2000.)

The tenant, Maria Joana de Conceição Pereira. (When visited in 2018.)

Other important data: The tenant family lives in this house as well as the house next door; they use both houses. The social security renovated and rebuilt the other house, which is thus in a better condition. The tenant does not remember any mud-house being constructed in her lifetime.

Perspectives of the building



In 2000

(Source: Correia, Le pise d'Alentejo, Portugal, 2000)



In 2018

Earth used & Typology



(Source: Correia, Le pise d'Alentejo, Portugal, 2000)



(Source: Correia, Le pise d'Alentejo, Portugal, 2000)

TECHNICAL DATA

Base course: 40cm; probably in stone masonry.

Flooring: 'Baldosa' (thin squared brick, typical from Alentejo).

Buttresses: None.

Corners: In rammed-earth and brick.

Openings: One door.

Roof type: 'Canal' tiles .

Thickness of exterior wall: 47cm. (Without plaster.)

Distinct architectural details: No.

Observations:

TYPOLICAL DATA (rammed-earth / cob)

Description of earth used: Presence of quartz.

Dimensions of the rammed-earth block: 1.60m x 50cm. (Two layers of rammed-earth in each block.)

Mortars: Vertical joints have 1.5cm of earth-mortar and horizontal joints have 4cm.

Plasters, pigments and/or paints: Lime plaster inside and outside. There is an earth based plaster on some parts of the main facade.

Distinct characteristics: In each block, there are two layers of rammed-earth.

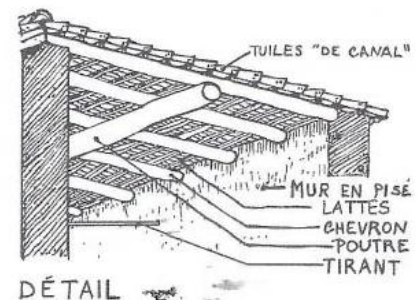
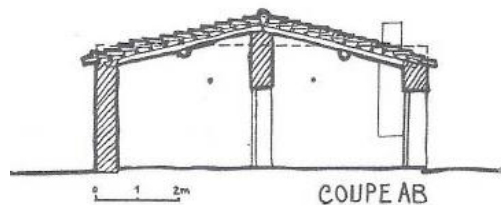
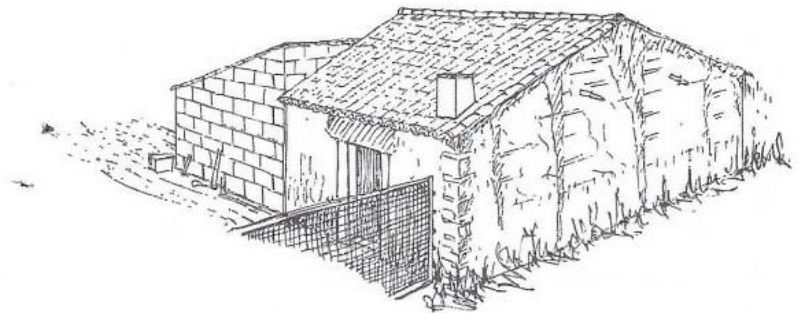
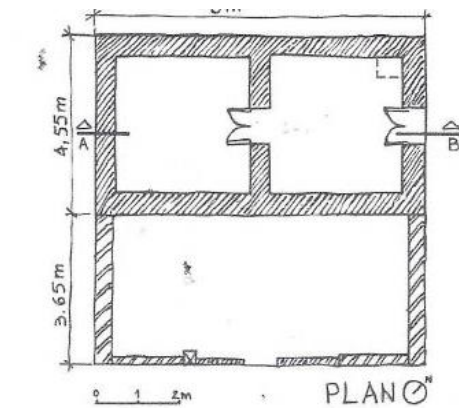

[Source: Correia, *Le pise d'Alentejo, Portugal*, 2000]



Front view.



[Source: Correia, *Le pise d'Alentejo, Portugal*, 2000]

Corners: In rammed-earth and brick.

X

X

X

X

CARE AND CONTINUITY

CONDITION ASSESSMENT

Damages incurred / problems faced:

No major damage incurred.

Observations:

MAINTENANCE AND REPAIRS

Preventive conservation:

Periodic interventions: Roof-tiles are rearranged and changed once in a while, mainly in summer.

Repairs: Cement is added on walls when needed.

Observations:

Other information: These repairs are done by the tenants son who is 49 years old.

Challenges faced today:

Future plans:

MAJOR CHANGES SINCE 2000

Now occupied by tenants. (Also refer 'Restorations or/and interventions' section.)

In 2000



(Source: Correia, *Le pise d'Alentejo, Portugal*, 2000)



(Source: Correia, *Le pise d'Alentejo, Portugal*, 2000)

In 2018



SURVEY NO. 6[14]

**The village of 'Aldeia da Luz' was submerged under water in around 2002 to make way for the Alqueva Dam. A new village called 'Luz' was created nearby for the displaced inhabitants. While the original village and its houses cease to exist, the people who inhabited them still live, and so do memories of 'Aldeia da Luz'...*

IDENTIFICATION

District: Évora.

Municipality: Mourão.

Parish: 'Aldeia da Luz'. (Documented in 2000.)

Nearest village: Aldeia da Luz. (Documented in 2000.)

Luz (Documented in 2018.)

Building name: 'Tapada das Vacas'.

Owner(s): António Fernandes.

Address: 'Tapada das Vacas', Rua da Tapada — Aldeia da Luz — 7200 Murão.

Directions: As you enter Aldeia da Luz via Murão, search for Tapada street (at the west of the village). At the end of the street, turn left onto a dirt-road. The building is on the left side.

Construction technique(s):
Rammed-earth i.e. 'taipa'.

Visited on: 21/04/2000.

Met concerned person on:
11/09/2018.

BUILDING DATA

CHRONOLOGICAL DATA

Construction date: 19th Century (+100 years). (Calculated in 2000.)

Builder: Mestre Afonso Caisaire (passed-away). He had built the house along with a helper ('*servente*' in Portuguese) and an apprentice.

Original use: Cow shed with an annexe for pigs.

Present use: In ruins. (Documented in 2000.)

Building no longer exists. (Documented in 2018.)

History of the building: The owner's wife's grandfather asked a rammed-earth builder to build it.

At some point in time, a man (not the owner) used to come with his cattle and let them graze in the space around the building. For the last few years of its existence, the building was not in use and was in a bad shape.

Restorations and/or interventions: The annexe for the pigs was built later, in 1980 with bricks.

Building in use or not: Discontinued to be used about 25 years back. (As calculated in 2000.)

Building ceased to exist in around the year 2000-2002. (Documented in 2018.)

Building at risk: Yes. (Documented in 2000.)

Information given by: The owner and Antónia Rosa dos Ramos, neighbour. (When visited in 2000.)

Antónia Rosa dos Ramos, 87 years. She was a neighbour in the old village, and now lives in the new one. (When visited in 2018.)

Other important data: Manuel Leão and Mansos Pinto (both passed-away) were rammed-earth builders from the village. People stopped constructing rammed-earth about 40-50 years ago. The village will be submerged in one year to allow the Alqueva Dam. (Documented in 2000.)

António had only one niece who was the heir to his property. She does not live in the new village, and was compensated with money instead of a house in Luz. The neighbour, Antónia and her husband had built their own rammed-earth house in 1951, after which only few more such houses were built in the village. She also remembers cement houses being built in the old village. (Documented in 2018.)

Perspectives of the building



(Source: Correia, *Le pise d'Alentejo, Portugal*, 2000)



(Source: Correia, *Le pise d'Alentejo, Portugal*, 2000)

Earth used & Typology



(Source: Correia, *Le pise d'Alentejo, Portugal*, 2000)



(Source: Correia, *Le pise d'Alentejo, Portugal*, 2000)

TECHNICAL DATA

Base-course: 1.20m; in schist and granite masonry.

Flooring:

Buttresses: Two; in schist.

Corners: In rammed-earth.

Openings: Four doors and two windows on the standing facades. (Documented in 2000.)

Roof type: No roof.

Thickness of exterior wall: 50cm.

Distinct architectural details: The size of the building.

Observations:

TYPOLICAL DATA (rammed-earth / cob)

Description of earth used: The earth is clayey. Includes lots of schist and a bit of quartz.

Dimensions of the rammed-earth block: 1.65m x 50cm.

Mortars: None.

Plasters, pigments and/or paints: There was clay and lime-wash.

Distinct characteristics: Schist between rammed-earth 'lifts' on exterior walls.

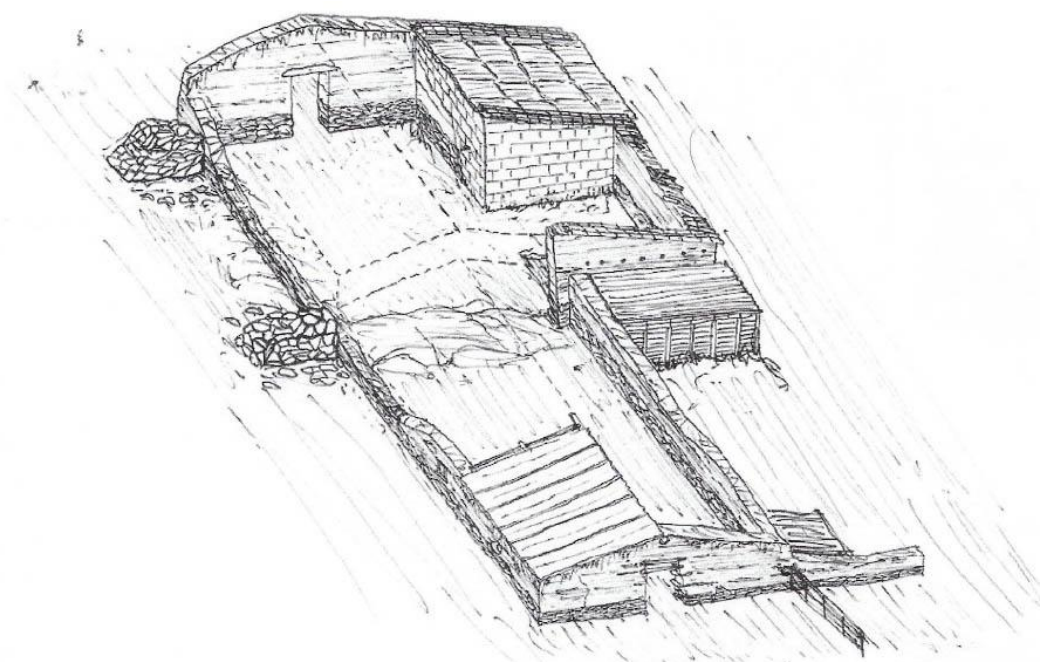
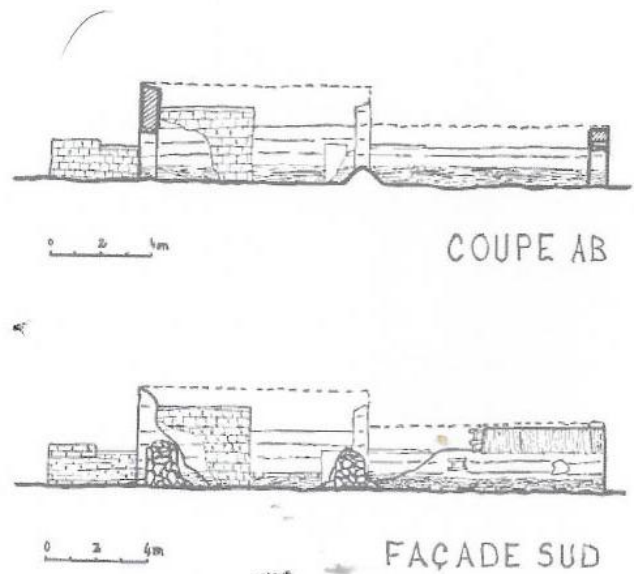
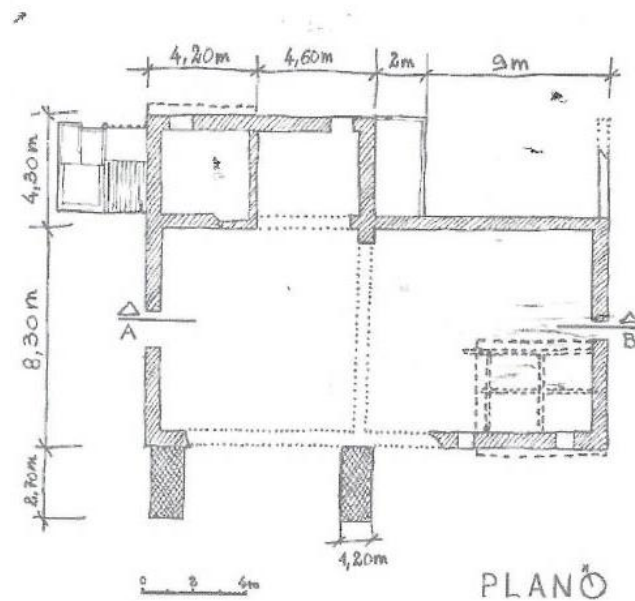

[Source: Correia, *Le pise d'Alentejo, Portugal*, 2000]

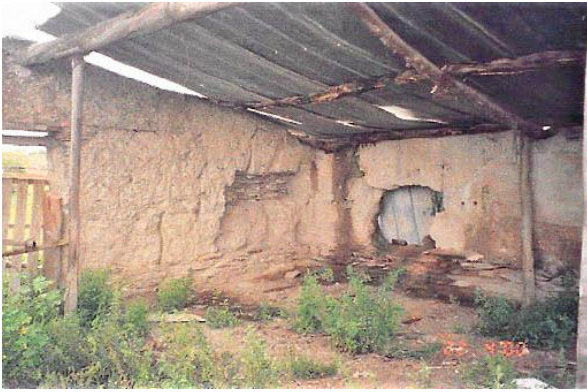

(Source: Correia, *Le pise d'Alentejo*, Portugal, 2000)

Interior view.



(Source: Correia, *Le pise d'Alentejo*, Portugal, 2000)

Schist and granite masonry.

Schist between 'lifts'.

Base-course: In schist and granite masonry.
Distinct characteristic: Schist between rammed-earth 'lifts' on exterior walls.



(Source: Correia, *Le pise d'Alentejo*, Portugal, 2000)

Buttresses: In schist.



(Source: Correia, *Le pise d'Alentejo*, Portugal, 2000)

Distinct characteristics: Schist between rammed-earth 'lifts' on exterior walls.



(Source: Correia, *Le pise d'Alentejo*, Portugal, 2000)

Use of stone in rammed-earth construction.



(Source: Correia, *Le pise d'Alentejo*, Portugal, 2000)

Use of stone in rammed-earth construction.

CARE AND CONTINUITY

CONDITION ASSESSMENT

Damages incurred / problems faced:

Observations:

MAINTENANCE AND REPAIRS

Preventive conservation:

Periodic interventions:

Repairs:

Observations:

Other information: According to Antónia, the house was never painted with lime.

Challenges faced today:

Future plans:

MAJOR CHANGES SINCE 2000

House no longer exists.

SURVEY NO. 7[39]

**The village of 'Aldeia da Luz' was submerged under water in around 2002 to make way for the Alqueva Dam. A new village called 'Luz' was created nearby for the displaced inhabitants. While the original village and its houses cease to exist, the people who inhabited them still live, and so do memories of 'Aldeia da Luz'...*

IDENTIFICATION

District: Évora.

Municipality: Murão.

Parish: Aldeia da Luz. (Documented in 2000.)

Nearest village: Aldeia da Luz. (Documented in 2000.)

Luz (Documented in 2018.)

Building name: 'Ramada'.

Owner(s): Leonel and António Rodrigo Correia. They live in Switzerland. (Documented in 2000.)

António Rodrigo Correia (passed-away); Leonel, 59 years old, lives in the new village, Luz. (Documented in 2018.)

Address: 'Ramada na Estrada da Tapada' — Aldeia da Luz — 7200 Mourão.

Directions: As you enter Aldeia da Luz via Murão, search for Tapada street (at the west of the village). At the end of Rua da Tapada, entre through the big metal gate and continue up the dirt-road. The building is to your left.

Construction technique(s): Rammed-earth i.e. 'taipa', presence of adobe-bricks.

Visited on: 05/08/2000.

Met concerned person on: 14/09/2018.

BUILDING DATA

CHRONOLOGICAL DATA

Construction date: 19th Century (+100 years). (Calculated in 2000.)

The bigger, rammed-earth part was roughly built before the 1940s. The pig-sty was built around 1973-74.

Builder: António Correia, owner's grandfather.

Original use: Shed for carriage + extension for pigs.

Present use: Warehouse. (Documented in 2000.)

Building no longer exists. (Documented in 2018.)

History of the building: António Correia constructed this building. His son Adérito also used it, but his children migrated.

The pig-sty was built with big schist stones and cement. The pigs were killed for family consumption only..

Restorations and/or interventions: Cement was used on the building at a later date; it was the only change incurred by the building.

Building in use or not: Still in use. (Documented in 2000.)

Building ceased to exist in around the year 2000-2002. (Documented in 2018.)

Building at risk: No. (Documented in 2000.)

Information given by: Clara Marques and her mother, neighbours. (When visited in 2000.)

Leonel Correia, owner. (When visited in 2018.)

Other important data: Known rammed-earth builders of the region were Afonso Caiseri (passed-away), Manuel Leal (passed-away) and Manuel Faria. The village would be submerged in one year's time in order to accommodate the Alqueva Dam. (Documented in 2000.)

Rammed-earth builders mentioned by Leonel were Belchior Rosado (passed-way), Afonso Carrilho (alive but too old), Manços Carrilho, Manuel Leal Carrilho, Manuel Leal (the latter two are two different people). (Documented in 2000.)

Perspectives of the building



[Source: Correia, *Le pise d'Alentejo, Portugal*, 2000]



[Source: Correia, *Le pise d'Alentejo, Portugal*, 2000]

Earth used & Typology



[Source: Correia, *Le pise d'Alentejo, Portugal*, 2000]



[Source: Correia, *Le pise d'Alentejo, Portugal*, 2000]

TECHNICAL DATA

Base-course: 95cm; in schist masonry.

Flooring: 'Cascahos', which is a white pebble flooring.

White pebbles of irregular size but somewhat flat on one side are chosen. The ground on which the flooring is to be laid is cleared and the pebbles are neatly arranged over it. Water is then poured over the pebbles and they are rammed with a ramming-tool. The ramming-tool used for 'cascahos' is different from that used for rammed-earth.

Buttresses: None.

Corners: In rammed-earth.

Openings: North facade.

Roof type: 'Canal' tiles.

Thickness of exterior wall: 47cm (west wall), 42cm (east wall).

Distinct architectural details: No.

Observations: Between the roof-line and the roof, there is a layer of schist and earth-mortar.

TYPOLOGICAL DATA (rammed-earth / cob)

Description of earth used: Significant quantities of grey clay and schist, and a bit of quartz.

Dimensions of the rammed-earth block: 1.70m x 50cm. (One layer.)

Mortars: None.

Plasters, pigments and/or paints: Thin layer of earth plaster.

Distinct characteristics: There is a layer of adobe-bricks between the rammed-earth 'lifts'. Size of adobe: 30cm (length) x 17cm (width) x 8cm (height).

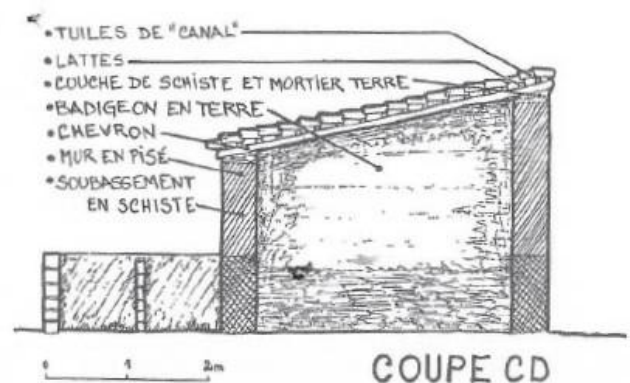
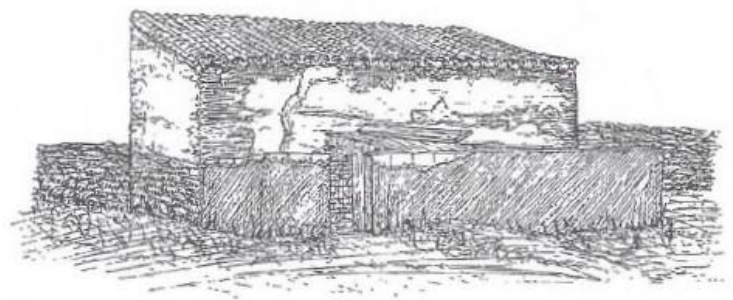
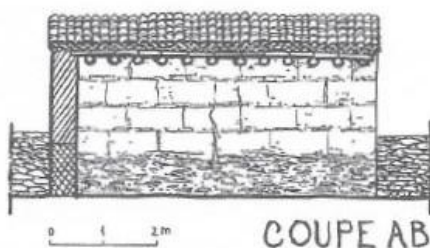
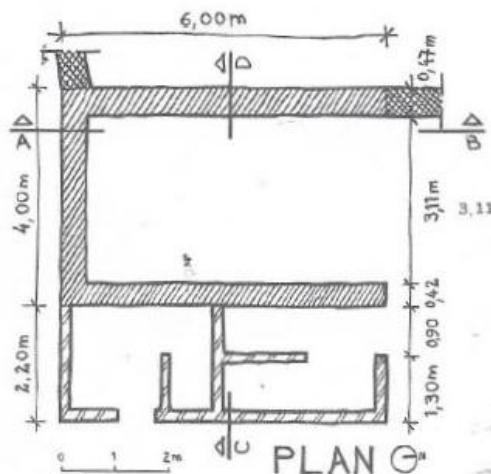

[Source: Correia, *Le pise d'Alentejo, Portugal*, 2000]



(Source: Correia, *Le pise d'Alentejo, Portugal*, 2000)

Interior view.



(Source: Correia, *Le pise d'Alentejo, Portugal*, 2000)

Distinct characteristics: There is a layer of adobe-bricks between the rammed-earth 'lifts'.

X

X

X

X

CARE AND CONTINUITY

CONDITION ASSESSMENT

Damages incurred / problems faced:
No.
Observations:

MAINTENANCE AND REPAIRS

Preventive conservation:
Periodic interventions:
Repairs:
Observations:
Other information: Leonel said that they never had a problem with the building, and that he trusts rammed-earth constructions.

Challenges faced today:

Future plans:

MAJOR CHANGES SINCE 2000

The house no longer exists. The original owner, António Rodrigo Correia has passed-away. His heir, Leonel, 59 years old, lives in the new village, Luz (documented in 2018).

SURVEY NO. 8[40]

**The village of 'Aldeia da Luz' was submerged under water in around 2002 to make way for the Alqueva Dam. A new village called 'Luz' was created nearby for the displaced inhabitants. While the original village and its houses cease to exist, the people who inhabited them still live, and so do memories of 'Aldeia da Luz'...*

IDENTIFICATION

District: Évora.

Municipality: Mourão.

Parish: Aldeia da Luz. (Documented in 2000.)

Nearest village: Aldeia da Luz. (Documented in 2000.)
Luz (Documented in 2018.)

Building name: 'Ramada'.

Owner(s): Irene Santana Fernandes (passed-away).

Address: 'Ramada na Estrada da Estrela' — Aldeia da Luz — 7200 Mourão.

Directions: From Aldeia da Luz village centre, turn to the first street on the left. Continue until the street ends and then turn to the left (opposite the graveyard). Continue onto the dirt-road for 50m. The building is on your right.

Construction technique(s):
Rammed-earth i.e. 'taipa', presence of adobe-bricks.

Visited on: 05/08/2000.

Met concerned person on:
11/09/2018.

BUILDING DATA

CHRONOLOGICAL DATA

Construction date: +/- 1950.

Builder: José Nunes Vidigal, former owner (passed-way).

Original use: Shed in which animals were killed.

Present use: Abandoned. (Documented in 2000.)

Building no longer exists. (Documented in 2018.)

History of the building: José Nunes Vidigal, Irene's father-in-law, constructed the building.

He built it himself with the help of an apprentice and others. This structure was a little away from the village and was surrounded by olive trees, vines, etc. The nearest house situated in the village was about 200-300m from the building. Irene's husband, Léonado Vidigal was an agriculturalist and used the building. He reared sheep, goats, etc. However, he later moved to France with his family and visited the village on vacation. He passed-away in 1993, after which Irene rented out the structure. Their son, João Vidigal, who was 9 years old when they shifted to France remembers the structure being used for donkeys too. After it was rented out, other animals were reared there.

Restorations and/or interventions: Yes, the roof structure was reinforced.

Building in use or not: Not in use since the former owner's death, 30 years ago. (Documented in 2000.)

Building ceased to exist in around the year 2000-2002. (Documented in 2018.)

Building at risk: Yes. (Documented in 2000.)

Information given by: Lourenço Leal, a neighbour. (When visited in 2000.)

João Vidigal, 61 years, Irene's son. He lives in France. He also has a house in Mourão, close to the Luz, and visits on vacation. And Rosa Maria Vidigal Santana, 94 years, João Vidigal's aunt. She lives in the new village, Luz. (When visited in 2018.)

Other important data: The last house built in rammed-earth in Aldeia da Luz was that of Lourenço Leal, no. 31, Rua Estrela. It was constructed by the mason, Afonso Leal Carrilho (He is now in the old age home in Mourão, documented in 2000). The village will be submerged in one year time to allow the Alqueva Dam. (Documented in 2000.)

Rosa and Mr. João remember that there were many rammed-earth buildings back in the days. By 1975-80, there were fired-bricks structures and other modern constructions.

Perspectives of the building



(Source: Correia, *Le pise d'Alentejo*, Portugal, 2000)



(Source: Correia, *Le pise d'Alentejo*, Portugal, 2000)

Earth used & Typology



(Source: Correia, *Le pise d'Alentejo*, Portugal, 2000)



(Source: Correia, *Le pise d'Alentejo*, Portugal, 2000)

TECHNICAL DATA

Base-course: 65cm; masonry in schist with some granite.

Flooring:

Buttresses: None.

Corners: In rammed-earth and schist.

Openings: North facade.

Roof type: 'Canal' tiles.

Thickness of exterior wall: 40cm.

Distinct architectural details: No.

Observations:

TYPOLOGICAL DATA (rammed-earth / cob)

Description of earth used: First 'lift' has a significant presence of silt and clay, and a bit of quartz. The second 'lift' is more red and has more schist.

Dimensions of the rammed-earth block: Both 'lifts' are 1.50m x 50cm.

Mortars: 1cm of earth-mortar.

Plasters, pigments and/or paints: None.

Distinct characteristics: There are adobe-bricks in the gable walls. Adobe-brick size: 33cm (length) x 16cm (width) x 10cm (height). The mud used for the rammed-earth walls is different from that used for the adobe-bricks.

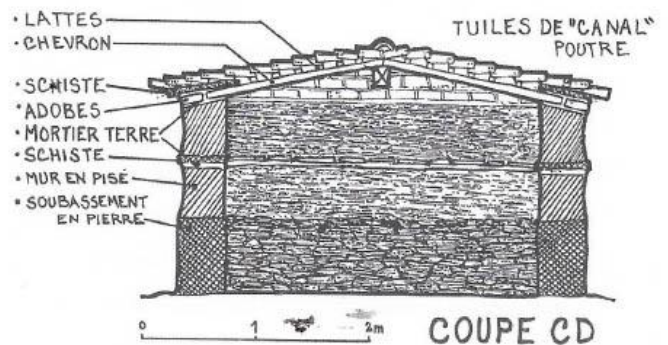
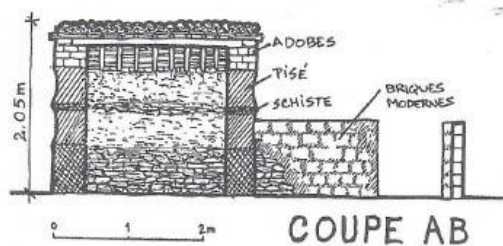
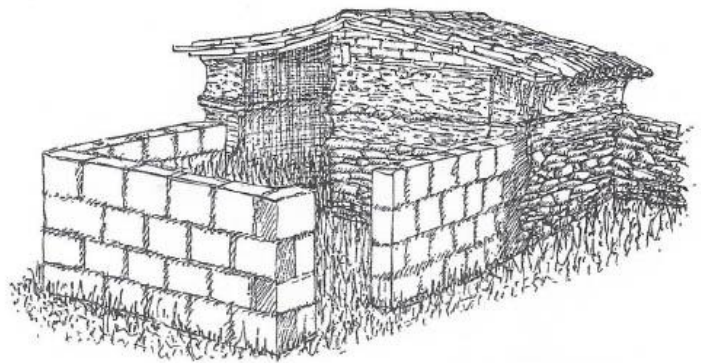
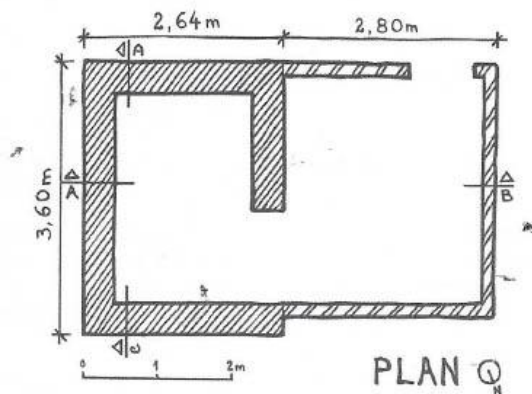

[Source: Correia, *Le pise d'Alentejo, Portugal*, 2000]



(Source: Correia, *Le pise d'Alentejo, Portugal*, 2000)

Description of earth used: The second 'lift' is more red and has more schist.



(Source: Correia, *Le pise d'Alentejo, Portugal*, 2000)

Distinct characteristics: There are adobe-bricks in the gable walls.

X

X

X

X

CARE AND CONTINUITY

CONDITION ASSESSMENT

Damages incurred / problems faced:
When João's grandfather was alive, there were no problems with the building. He had built it, so he took good care while using it. When João's father moved to France, the building was rented-out and the tenants did not do much to maintain the structure.
Observations:

MAINTENANCE AND REPAIRS

Preventive conservation:
Periodic interventions: No.
Repairs: (Refer 'Restorations or/and interventions' section.)
Observations:
Other information:

Challenges faced today:
Future plans:

MAJOR CHANGES SINCE 2000

House no longer exists.

SURVEY NO. 9[18]

**This rammed-earth building was lost in a fire, and is rebuilt in cement.*

IDENTIFICATION

District: Beja.

Municipality: Moura.

Parish: Safara.

Nearest village: Safara.

Building name: 'Cabana das Vacas do Monte Valvinagrinho'.

Owner(s): António Manuel Feijão. He lives in Reguengos de Monsaraz. (62 years old, in 2018.)

Address: 'Cabana de Vacas do Monte Valvinagrinho', Safara — 7875 Safara.

Directions: From Safara, take the road towards Moura. The building is 4km ahead, on the left side. The road is just 5m away from the building.

Construction technique(s):
Rammed-earth i.e. 'taipa'.

Visited on: 22/04/2000.

Revisited on: 07/09/2018.

Met concerned person on:
07/09/2018.

BUILDING DATA

CHRONOLOGICAL DATA

Construction date: Unknown.

Builder: Unknown.

Original use: Cattle shed.

Present use: Storage for agricultural machines.

History of the building: Four years ago, José Frederico, the former owner, sold the building to António Manuel Feijão. (Documented in 2000.)

Restorations and/or interventions: The buttresses were added on a later date, after the construction of the building. A year ago, the roof and part of the walls were taken down in order to reconstruct the building. The project however, could not continue as the city council wanted a restoration rather than a reconstruction. Today, the process is stopped and the matter is in the court. (Documented in 2000.)

Since then, the owner had won the court case. The idea was to have a building with higher walls so that the farm machinery would fit inside. As the authorities would not allow him to go forward with his plan, he installed an independent metal roof over the structure. He later thought of keeping the rammed-earth walls and had European funding for the same. But in around the year 2000, the building caught fire. The straw that was stocked inside the building caught a spark when a child was playing with a lighter, and the building burnt down and fell. The firemen had to break a wall to get in. It is now reconstructed using cement blocks and metal. None of the old rammed-earth walls remain. (Documented in 2018.)

Building in use or not: Still in use.

Building at risk: Yes, the main facade is at risk. (Documented in 2000.)

The building is reconstructed. (Documented in 2018.)

Information given by: António Paulo Bicho. (When visited in 2000.)

António Manuel Feijão, owner. (When visited in 2018.)

Other important data: The building is protected by the city council as an historical monument. (Documented in 2000.)

Perspectives of the building



Earth used & Typology



TECHNICAL DATA

Base-course: 50cm; only in the north facade. In stone masonry.

Flooring:

Buttresses: Two on the north side; in stone.

Corners: In rammed-earth.

Openings: A door and a window. (Documented in 2000.)

Roof type: 'Canal' tiles, already fallen.

Thickness of exterior wall: 50cm. (Without plaster.)

Distinct architectural details: West facade dimension, which is still standing. (Documented in 2000.)

Observations:

TYOLOGICAL DATA (rammed-earth / cob)

Description of earth used: The soil particles are very fine. However, there is a possibility that more silt, rather than clay is present.

Dimensions of the rammed-earth block: 1.60m x 55cm.

Mortars: Used along horizontal joints, rarely along vertical ones.

Plasters, pigments and/or paints: Earthen plaster, but in some parts a cement-plaster is added. White coloured wall(s).

Distinct characteristics: Most vertical joints are slanting.

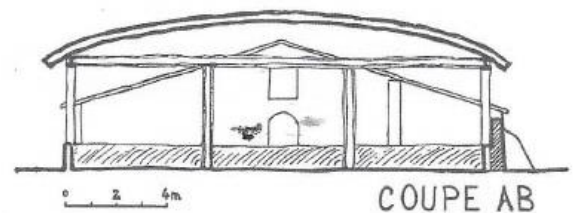
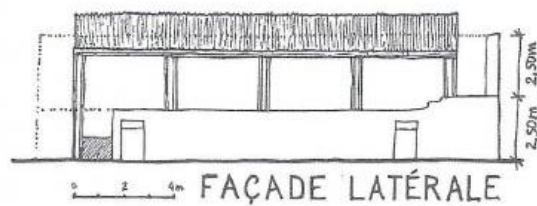
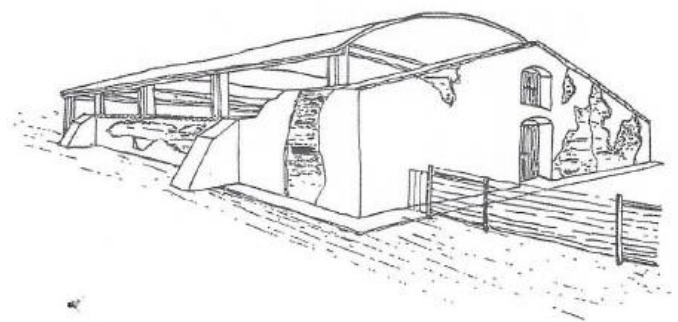
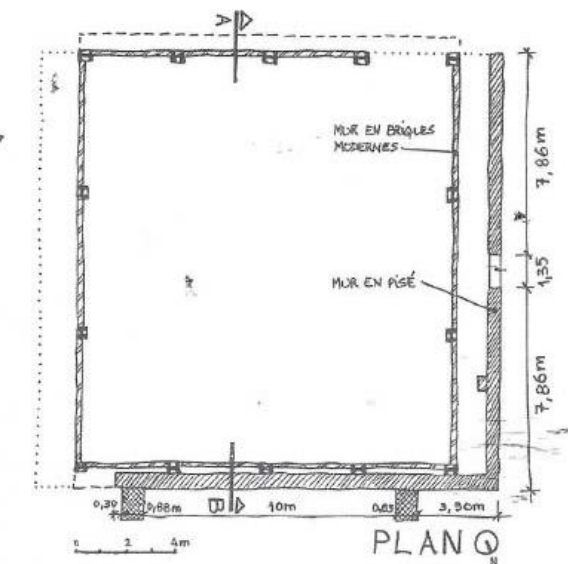

[Source: Correia, *Le pise d'Alentejo, Portugal*, 2000]

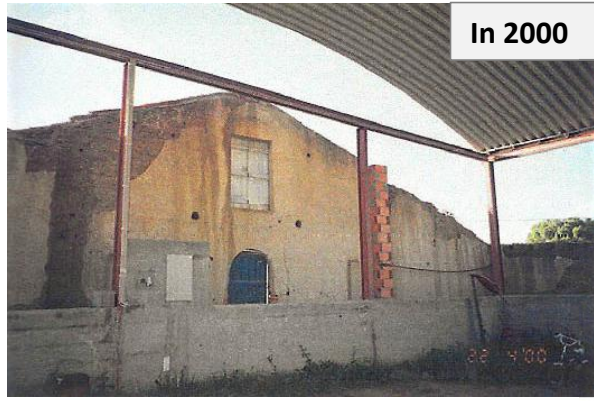

(Source: Correia, *Le pise d'Alentejo, Portugal, 2000*)

Interior view before the fire.



Interior view after the structure was rebuilt.

X

X

X

X

CARE AND CONTINUITY

CONDITION ASSESSMENT

Damages incurred / problems faced: Cracks on walls (old earth construction that existed in 2000). Fire damaged the walls and part of the metal roof as well.

Observations:

MAINTENANCE AND REPAIRS

Preventive conservation:

Periodic interventions: Every year, the roof had to be reworked on because the winds would cause the tiles to dislocate. The woodwork needed repairs too. (Old roof on earth construction that existed in 2000).

Repairs: Cracks on walls were repaired using sand (4 portions) + lime (2 portions) + cement (1 portion). Lime was bought in powder form; sand was also bought. A labourer was hired to do the work.

Observations:

Other information:

Challenges faced today:

Future plans: No, the owner uses the building to house his farm machinery.

MAJOR CHANGES SINCE 2000

The building caught fire. No rammed-earth walls remain. It was **rebuilt**, and is covered on all four sides by cement blocks and metal sheets.

In 2000



(Source: Correia, Le pise d'Alentejo, Portugal, 2000)



(Source: Correia, Le pise d'Alentejo, Portugal, 2000)

In 2018



SURVEY NO. 10[19]

IDENTIFICATION

District: Beja.

Municipality: Moura.

Parish: Safara.

Nearest village: Safara.

Building name: 'Monte Valvinagrinho's workers' house.

Owner(s): António Manuel Feijão. He lives in Reguengos de Monsaraz. (62 years old, in 2018.)

Address: 'Casa dos Trabalhadores do Monte Valvinagrinho', Safara — 7875 Safara.

Directions: From Safara, take the road towards Moura. The building is 4km ahead, on the right side. The road is just 5m away from the building.

Construction technique(s): Rammed-earth i.e. 'taipa'.

Visited on: 22/04/2000.

Revisited on: 07/09/2018.

Met concerned person on: 07/09/2018.

BUILDING DATA

CHRONOLOGICAL DATA

Construction date: Unknown.

Builder: Unknown.

Original use: Worker's house.

Present use: Warehouse.

History of the building: Four years ago, José Frederico, the former owner, sold the building to António Manuel Feijão. (Documented in 2000.)

The former owner used the house for agricultural purposes. The current owner also uses it for agricultural purposes; he has never lived there. (Documented in 2018.)

Restorations and/or interventions: The buttresses were added on a later date, after the construction of the building.

Building in use or not: Still in use.

Building at risk: Yes, a part of the roof over two rooms has already fallen. (Documented in 2000.)

No. (Documented in 2018.)

Information given by: António Paulo Bicho. (When visited in 2000.)

António Manuel Feijão, current owner. (When visited in 2018.)

Other important data: The building is protected by the city council. (Documented in 2000.)

Perspectives of the building



Earth used & Typology



TECHNICAL DATA

Base-course: Impossible to determine.

Flooring:

Buttresses: Three on the west side.

Corners: Impossible to determine.

Openings: Six doors and one window.

Roof type: 'Canal' tiles. One part has already fallen.
(Documented in 2000.)

Roof repaired. (Documented in 2018.)

Thickness of exterior wall: 55cm. (With plaster.)

Distinct architectural details: No.

Observations:

TYPOLOGICAL DATA (rammed-earth / cob)

Description of earth used: The soil particles are very fine. However, there is a possibility that more silt, rather than clay is present.

Dimensions of the rammed-earth block: Impossible to determine.

Mortars: Impossible to determine.

Plasters, pigments and/or paints: Lime + sand, white walls. (In 2000.)

Wall-bases have a blue colour. (In 2018.)

Distinct characteristics:

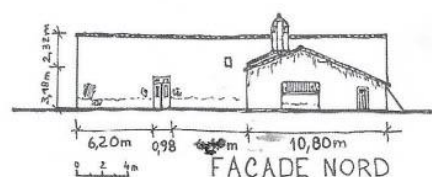
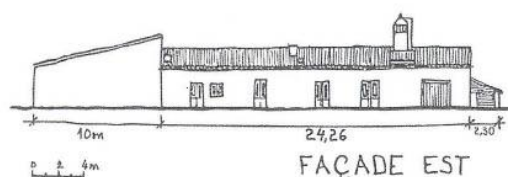
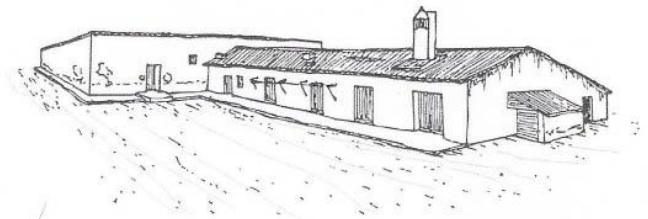
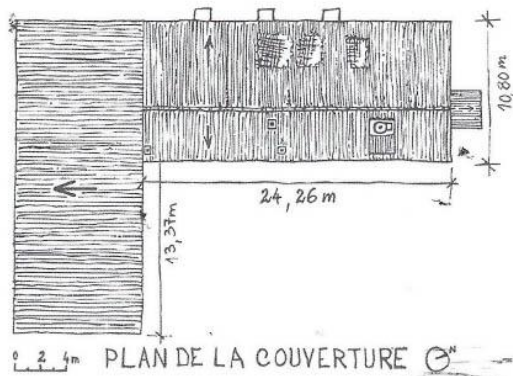

[Source: Correia, *Le pise d'Alentejo, Portugal*, 2000]



Interior view.



Roof framework.



Flooring types in the house.



Damages incurred / problems faced: Warping, cracking and fallen plaster.

CARE AND CONTINUITY

CONDITION ASSESSMENT

Damages incurred / problems faced:

The roof gets damaged frequently because it is big, thus causing the winds to easily affect its stability. In November 2005, a strong storm brought down the whole chimney and created an opening in the roof.

Observations: Warping, cracking and fallen plaster. Some floor-tiles chipped-off.

MAINTENANCE AND REPAIRS

Preventive conservation:

Periodic interventions: Every year, the roof had to be reworked on because the winds would cause the tiles to dislocate. The woodwork needed repairs too. Roof-tiles and wood in the roof's framework was replaced as and when needed. These repairs were done between the months of May and September, when it was dry and least likely to rain. Earlier, walls were whitewashed every year.

Repairs: The roof has been repaired many times.

Observations: Some parts of walls are fixed with cement.

Other information:

Challenges faced today:

Future plans: No future plans as of now.

MAJOR CHANGES SINCE 2000

Chimney no longer there, roof repaired, blue paint along wall-bases on front facades.

In 2000



(Source: Correia, Le pise d'Alentejo, Portugal, 2000)



(Source: Correia, Le pise d'Alentejo, Portugal, 2000)

In 2018



SURVEY NO. 11[25]

IDENTIFICATION

District: Beja.

Municipality: Serpa.

Parish: Salvador.

Nearest village: Vales Mortos.

Building name: 'Vacaria do Monte do Ti Zé Marques'.

Owner(s): Xisto Vaz.

Address: 'Vacaria do Monte do Ti Zé Marques', 7830 Vales Mortos — Serpa.

Directions: The building is on the left side, 7.6km from Vales Mortos (towards Serpa) and 4.4km before Santa Iria. It is located in front of a bus stop and 400m before the signpost, 'Agroturismo — Herdade do Topo'.

Construction technique(s):

Rammed-earth i.e. 'taipa'.

Visited on: 25/04/2000.

Revisited on: 17/09/2010.

Met concerned person in: December 2018.

(Rui Cambraia, a Photographer and Journalist from Serpa interviewed the current owner for this case-study.)

BUILDING DATA

CHRONOLOGICAL DATA

Construction date: 19th Century (+/- 100 years). (Calculated in 2000.)

Builder: José Marques, the first owner constructed the building himself.

Original use: Corral for cattle.

Present use: Abandoned. (Documented in 2000 and 2018.)

History of the building: The building belonged to José Marques, who sold it to Dr. Pereira Coelho from 'Herdade da Chaminé'. Some years ago, it was sold to the current owner, Xisto Vaz.

Restorations and/or interventions: None.

Building in use or not: Not used for the last 35 years. (As calculated in 2000.)

Building at risk: Yes, a part of the walls fell down. (Documented in 2000.)

Many parts of the walls have fallen down. The building is in ruins. (Documented in 2018.)

Information given by: Augusto Filipe Horta, José da Conceição Horta and Almerinda Isabel Nunes. (When visited in 2000.)

Xisto Vaz, owner (When visited in 2018).

Other important data: The building and the property papers are still in the name of José Marques, the first owner who built the structure. The region's inhabitants say that for rammed-earth constructions, the earth from Vales Mortos is better than that from Serpa. That is why this region's buildings do not need plaster, whereas those in Serpa do. (Documented in 2000.)

There is a notice on the entrance gate stating that the property benefits from the Rural Development Programme through public and European funding. (Documented in 2018.)

Perspectives of the building



Earth used & Typology



(Source: Correia, Le pise d'Alentejo, Portugal, 2000)



(Source: Correia, Le pise d'Alentejo, Portugal, 2000)

TECHNICAL DATA

Base-course: 30cm; in stone. In the second division, there is fired-brick masonry on the top of the stone base-course.

Flooring:

Buttresses: None.

Corners: In rammed-earth and fired-bricks. There are two layers of bricks every 50cm.

Openings: Two openings.

Roof type: In ruins.

Thickness of exterior wall: 50cm.

Distinct architectural details: No.

Observations: Dimensions of the fired-bricks on corners and **Base-course:** 40cm (length) x 29cm (width) x 5.5cm (height).

TYPOLOGICAL DATA (rammed-earth / cob)

Description of earth used: Presence of lots of schist and quartz.

Dimensions of the rammed-earth block: 1.50m x 50cm.

Mortars: 4cm along horizontal layer, 1.5cm along vertical layer.

Plasters, pigments and/or paints: Some cement-plaster (exterior). Existing plaster is lime based (interior).

Distinct characteristics: The rammed-earth walls are very well compacted and aligned. The vertical joints can be found above the holes left by the rammed-earth form-work. Some parts of the walls have slanting joints. There is evidence of schist between the rammed-earth 'lifts'.

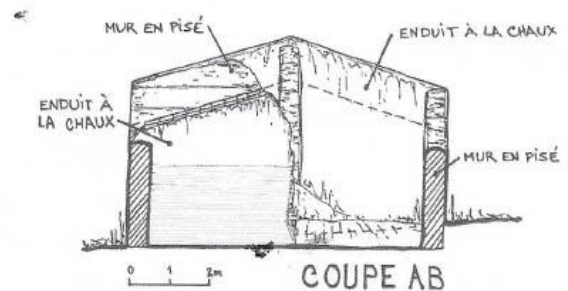
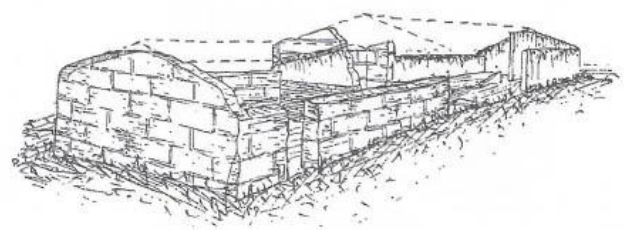
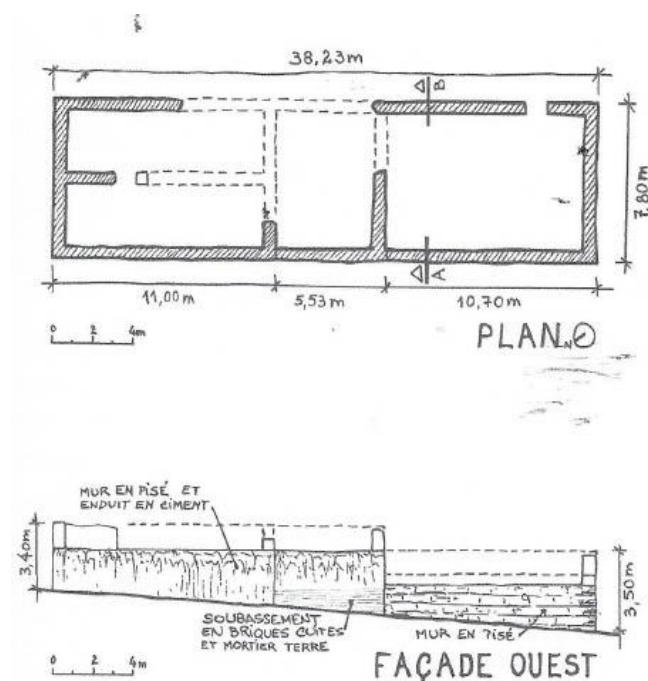

[Source: Correia, *Le pise d'Alentejo, Portugal*, 2000]



Base-course: In the second division, there is fired-brick masonry on the top of the stone base-course.



Base-course: 0.30m; in stone. Corners: In rammed-earth and fired-bricks. Distinct characteristics: Evidence of schist between the rammed-earth 'lifts'.



Damages incurred / problems faced: Holes in walls especially where there is lime-based plaster.



Damages incurred / problems faced: Wall damages got worse with time as the building has not had a roof for many years, some parts of the walls have fallen, vegetation in and around the structure.

CARE AND CONTINUITY

CONDITION ASSESSMENT

Damages incurred / problems faced: Roof tiles were stolen in April 1974. Wall damages got worse with time as the building has not had a roof for many years, and the walls were exposed to rainwater. Cows scratch the base of walls.

Observations: Some parts of the walls have fallen, there are cracks, degraded bricks and mortars, graffiti on north wall, holes in walls especially where there is lime-based plaster, vegetation on and round the walls.

MAINTENANCE AND REPAIRS

Preventive conservation:

Periodic interventions:

Repairs: No

Observations:

Other information:

Challenges faced today: The structure is in ruins.

Future plans: The owner would like to build a house in the same place with bricks as he does not trust rammed-earth constructions.

MAJOR CHANGES SINCE 2000

Parts of rammed-earth walls have fallen.

In 2000



(Source: Correia, *Le pise d'Alentejo, Portugal*, 2000)

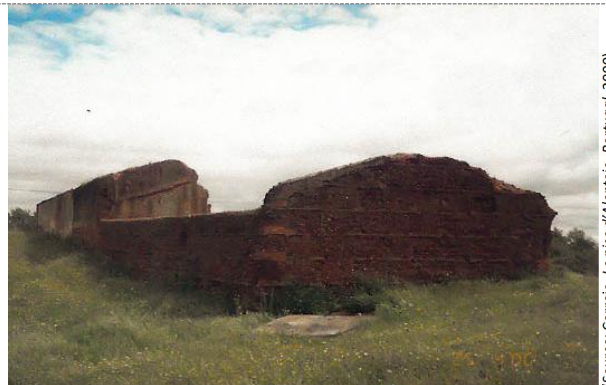

(Source: Correia, *Le pise d'Alentejo, Portugal*, 2000)

In 2018



SURVEY NO. 12[27]

IDENTIFICATION

District: Beja.

Municipality: Serpa.

Parish: Santana de Cambas.

Nearest village: Vales Mortos.

Building name: 'Monte dos Sobreiros'.

Owner(s): Virginia Martins Gonçalves and her husband. (Documented in 2000.)

Paula Silvestre – owner's daughter. The owners live in Lisbon. (Documented in 2018.)

Address: 'Monte dos Sobreiros' - Vale do Poço, 7830 Vales Mortos — Serpa.

Directions: The building is on the right side, in front of the gas station, 4km after Vales dos Mortos (towards Mértola).

Construction technique(s):
Rammed-earth i.e. 'taipa'.

Visited on: 25/04/2000.

Revisited on: 17/09/2018.

BUILDING DATA

CHRONOLOGICAL DATA

Construction date: 1998.

Builder: António Martins Inácio, 52 years old. He lives in 'Monte dos Valentins', Vales Mortos. (Documented in 2000.)

Original use: House.

Present use: House (vacation home).

History of the building: The builder asked if he could construct the building in rammed-earth, and the owners thought that it was a good idea. The earthen walls was built very quickly i.e. within a month. The earth was taken from the property and its surroundings.

There are two houses on the property, next to each other. One is Monte dos Sobreiros, and the other with an attached garage. António built both these houses in rammed-earth (except the garage) at around the same time. There were 5-6 men involved: 2 for digging and mixing, 1 to transport the earth to the building being built, and 2 for ramming.

Restorations and/or interventions: The building was plastered recently. (Documented in 2000.)

An extension to the house is added on the south. The material with which it is built cannot be seen because the house is plastered. The demarcated open space in front of the house is no longer exists. Instead, there is a lean-to all along the front and back facade of the house. Blue paint borders the doors and windows. (Documented in 2018.)

Building in use or not: Still in use.

Building at risk: No.

Information given by: Virginia Martins Gonçalves, the owner. (When visited in 2000.)

Margarida Silvestre, the lady at the nearby gas station. And António Martins Inácio, builder and mason. (When visited in 2018.)

Other important data: It is a rammed-earth building. The foundation was built with stone. The inside walls are built with modern bricks, and the walls are plastered in cement. In Vale do Poço, Francisco Simão, Januário's father-in-law was a rammed-earth builder. He is now retired. (Documented in 2000.)

Many of the rammed-earth builders of the region have passed-away. Manuel Humberto, who lives near Vale do Poço is still alive. There is another one in Vale de Paredes, Monte dos Valentins. Access to the inside of the house was not possible as the owners were not present. (Documented in 2018.)

Perspectives of the building



Earth used & typology cannot be seen as the whole structure is plastered.

TECHNICAL DATA

Base-course: None, but the foundation is 50cm.

Flooring:

Buttresses: None.

Corners: In stone.

Openings: One door and five windows. (Documented in 2000.)

One door and seven windows, as the house is extended. (Documented in 2018.)

Roof type: 'Aba e canudo'.

Thickness of exterior wall: 55cm. (With plaster.)

Distinct architectural details: No.

Observations: Metal supports for ceiling.

TYPOLOGICAL DATA (rammed-earth / cob)

Description of earth used: Unable to observe as the house is plastered.

Dimensions of the rammed-earth block: Unable to observe as the house is plastered.

Mortars: None.

Plasters, pigments and/or paints: In cement, white. (In 2000.)

Blue around door and window frames. (In 2018.)

Distinct characteristics: No.

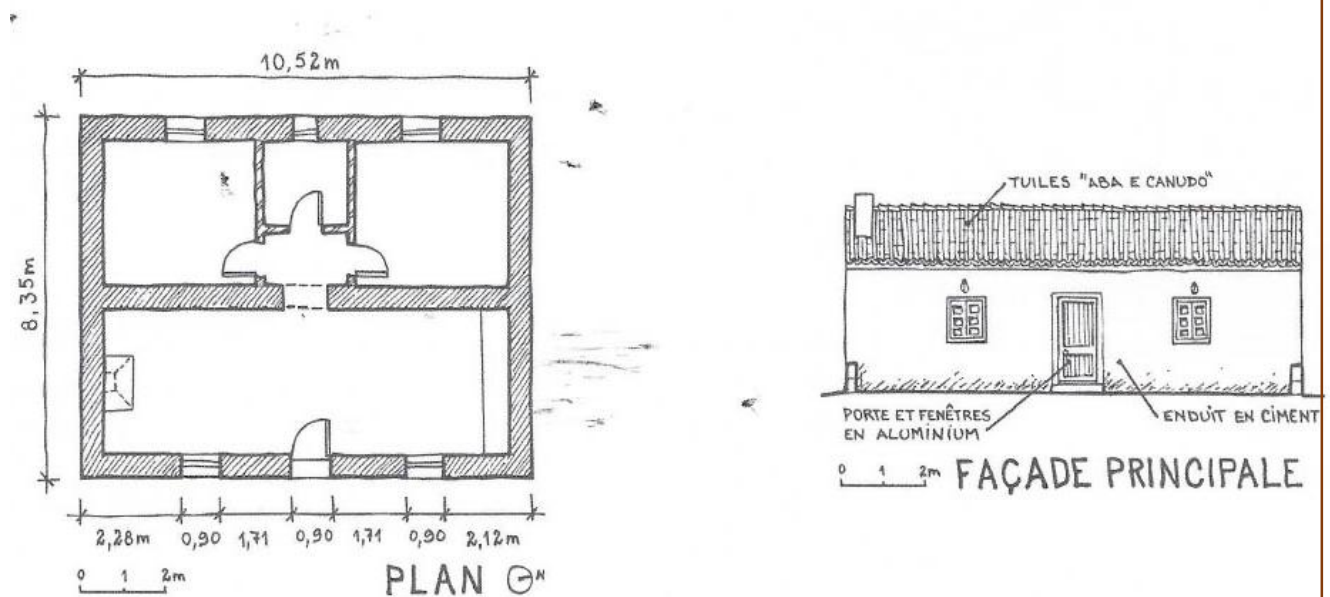

[Source: Correia, *Le pise d'Alentejo, Portugal*, 2000]



In 2000

Front view.

(Source: Correia, *Le pise d'Alentejo, Portugal, 2000*)



In 2018

Front view.



In 2000

Back view.

(Source: Correia, *Le pise d'Alentejo, Portugal, 2000*)



In 2018

Back view.

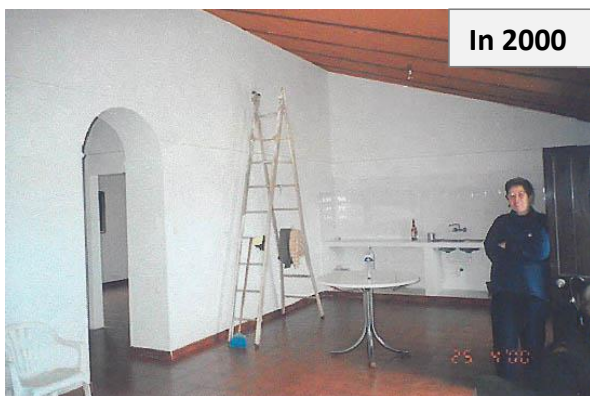

In 2000

Interior view.

(Source: Correia, *Le pise d'Alentejo, Portugal, 2000*)



Damages incurred / problems faced: There is a vertical crack along the front facade; it demarcates the new extension.

CARE AND CONTINUITY

CONDITION ASSESSMENT

Damages incurred / problems faced:

Observations: There is a vertical crack along the front facade; it demarcates the new extension.

MAINTENANCE AND REPAIRS

Preventive conservation:

Periodic interventions:

Repairs:

Observations:

Other information:

Challenges faced today:

Future plans:

MAJOR CHANGES SINCE 2000

(Refer 'Restorations or/and interventions' section.)

In 2000



(Source: Correia, Le pise d'Alentejo, Portugal, 2000)



(Source: Correia, Le pise d'Alentejo, Portugal, 2000)

In 2018



7.3. PHOTO DOCUMENTATION: SURVEYS IN 2000 AND 2018

In Mariana's study ('*Le Pise d'Alentejo*' (2000); '*Taipa no Alentejo. Rammed Earth in Alentejo*' (2007)), the 40 case-studies that were conducted were categorised into nine study areas i.e. 'Region A' to 'Region I' based on their location. As part of this study, 'Comparison of the Vernacular Earthen Architecture of Goa (past Portuguese colony in India) and Alentejo (Portugal): Local Building Cultures and Conservation Approaches', 23 of the 40 houses were revisited in 2018, out of which 12 were re-analysed and the case-studies were updated (previous pages).

The other 11 structures were also documented through photos. Following are pictures of what these 11 buildings looked like in 2000, and then in 2018. The Regions and Survey numbers are marked according to Mariana's study.

'REGION A' — REGUENGOS DE MONSARAZ, ÉVORA

SURVEY NO. [2]

Monte Novo da Coutada, Telheiro



SURVEY NO. [4]

Maison du Moulin, Telheiro

In 2000



(Source: Correia, *Le pise d'Alentejo, Portugal*, 2000)



(Source: Correia, *Le pise d'Alentejo, Portugal*, 2000)

In 2018



SURVEY NO. [5]

Monte da Bulhoa, Outeiro

In 2000



(Source: Correia, *Le pise d'Alentejo, Portugal*, 2000)



(Source: Correia, *Le pise d'Alentejo, Portugal*, 2000)

In 2007



(Source: Correia, *Tatipa No Alentejo*, 2007)

In 2018



SURVEY NO. [7]

Monte do Branquinho, Outeiro

In 2000



(Source: Correia, *Le pise d'Alentejo, Portugal, 2000*)



(Source: Correia, *Le pise d'Alentejo, Portugal, 2000*)

In 2018



SURVEY NO. [8]

In Outeiro

In 2000



(Source: Correia, *Le pise d'Alentejo, Portugal, 2000*)



(Source: Correia, *Le pise d'Alentejo, Portugal, 2000*)

In 2018



'REGION B' — REDONDO, ÉVORA

SURVEY NO. [13]

Monte Pirinéu, Aldeias de Montoito

In 2000



(Source: Correia, *Le pise d'Alentejo, Portugal, 2000*)

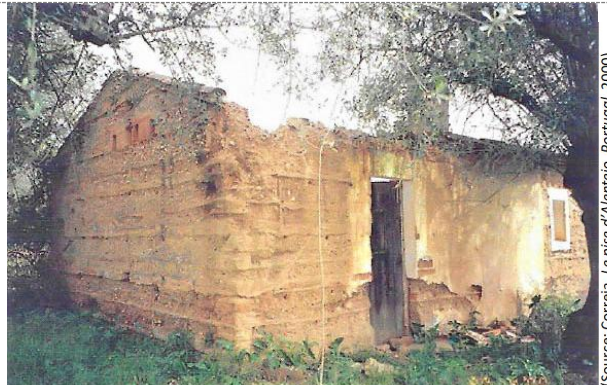

(Source: Correia, *Le pise d'Alentejo, Portugal, 2000*)

In 2018



'REGION D': MOURA, BEJA

SURVEY NO. [20]

Casa de Ciganos, Safara

In 2000

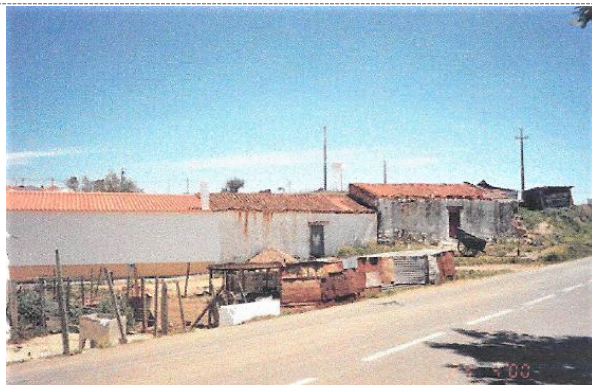

(Source: Correia, *Le pise d'Alentejo, Portugal, 2000*)



(Source: Correia, *Le pise d'Alentejo, Portugal, 2000*)

In 2018



SURVEY NO. [21]

Oficina de Abugão, Safara

In 2000



(Source: Correia, *Le pise d'Alentejo*, Portugal, 2000)



(Source: Correia, *Le pise d'Alentejo*, Portugal, 2000)

In 2018



'REGION E' — SERPA, BEJA

SURVEY NO. [26]

Monte das Fontainhas, Vales Mortos

In 2000



(Source: Correia, *Le pise d'Alentejo*, Portugal, 2000)



(Source: Correia, *Le pise d'Alentejo*, Portugal, 2000)

In 2018



'REGION I' — ALCÁCER DO SAL, SETÚBAL

SURVEY NO. [35]

Monte do Courela, Alcácer do Sal

In 2000



(Source: Correia, *Le pise d'Alentejo, Portugal*, 2000)



(Source: Correia, *Le pise d'Alentejo, Portugal*, 2000)

In 2018



SURVEY NO. [37]

Casas dos Romeiros, Alcácer do Sal

In 2000



(Source: Correia, *Le pise d'Alentejo, Portugal*, 2000)



(Source: Correia, *Le pise d'Alentejo, Portugal*, 2000)

In 2018



8. RESEARCH REPORT — ALENTEJO

**The building in Survey 9[18] ('Region D') is rebuilt in cement, and those in Survey nos. 6[14], 7[39], 8[40] ('Region C') have ceased to exist as they were submerged under water to accommodate the Alqueva dam. However, when conducting analyses for this study, the rammed-earth buildings were considered.*

Following the methodology adopted to analyse the buildings surveyed in Goa, the 12 case-studies that were updated in Alentejo in 2018 were (re)analysed on the bases of the:

- Local building cultures that existed within Alentejo
- Construction details
- Conservation approaches employed

8.1. ANALYSES OF LOCAL BUILDING CULTURES — ALENTEJO

Revised and rewritten by Chenelle Rodrigues based on the work of Mariana Correia ('Pise d'Alentejo,' 2000; 'Taipa no Alentejo. Rammed Earth in Alentejo,' 2007).

In keeping with the method of analyses employed in the study completed in 2000 and published in 2007, the 12 case-studies that were updated for the purpose of this study are classified into five study areas i.e. 'Region A' to 'Region E', depending on the municipalities they were located in.

- 'Region A' — Reguengos de Monsaraz, Évora (Two case-studies: Survey nos. 1[1], 2[38]).
- 'Region B' — Redondo, Évora (Three case-studies: Survey nos. 3[9], 4[10], 5[11]).
- 'Region C' — Mourão, Évora (Three case-studies: Survey nos. 6[14], 7[39], 8[40]).
- 'Region D' — Moura, Beja (Two case-studies: Survey nos. 9[18], 10[19]).
- 'Region E' — Serpa, Beja (Two case-studies: Survey nos. 11[25], 12[27]).

8.1.1. 'REGION A' — REGUENGOS DE MONSARAZ, ÉVORA

Location (village / nearest village)

Telheiro — Survey no. 1[1].

São Pedro do Corval — Survey no. 2[38].

Construction technique(s)

Rammed-earth — Survey nos. 1[1], 2[38].

Adobe-bricks — Survey no. 2[38] (internal walls).

Rammed-earth dimensions

2.50m x 50cm — Survey no. 1[1].

1.56m x 50cm — Survey no. 2[38].

Adobe-bricks dimensions

30cm (length) x 20cm (width) x 10cm (height) — Survey no. 1[1] (internal walls).

Exterior wall thickness

50cm — Survey nos. 1[1], 2[38].

Soil types

- Vx i.e. Red or yellow Mediterranean soils, with schist — Survey no. 1[1].
- Pmg i.e. Grey Mediterranean soils, with quartzitic diorites — Survey no. 2[38].

Walls

The rammed-earth blocks presented a wide variety of dimensions. This was probably due to the fact that some owners had their own wooden form-work; the form-work was referred to as 'taipas'. Some of the people to whom Mariana spoke still had their form-work kept aside and abandoned in a corner of their storehouses. Some also had their adobe-brick moulds.

In general, the wall thickness was 50cm.

The soil used to build the rammed-earth walls had a lot of schist with enough clay to bind it. The walls in this region were strong, which probably explains the absence of plaster on most of the houses in this region. Usually, only the main facade was finished with a plaster and lime wash (Survey no. 1[1]). Sometimes, the side facades were protected by an earth-wash (Survey no. 2[38]).

Building typology

The rammed-earth buildings surveyed in this region displayed a simple typology i.e. walls without mortar or other materials; the joints were hard to observe (Survey no. 1[1]), or the 'lifts' were separated by a layer of mortar + fired-bricks (Survey no. 2[38]), or just mortar. Either one or two layers of rammed-earth per block were also identified in Survey no. 2[38]. Generally, this region is characterised by the presence of a very good quality soil for rammed-earth constructions, and does not call for additional reinforcement. However, the earth in the region surrounding Reguengos de Monsaraz is of inferior quality for rammed-earth constructions, and demand horizontal reinforcements. The rammed-earth surrounding Reguengos de Monsaraz has the same typology as Survey no. 2[38].



Image 170: Simple typology i.e. walls without mortar or other materials (Survey no. 1[1]).



Image 171: 'Lifts' separated by a layer of mortar + fired-bricks (Survey no. 2[38]).

Base-course and corners

The base-course was usually constructed in schist (Survey no. 1[1]), and sometimes with granite.

The corners were built in rammed-earth (Survey no. 1[1]), fired-bricks (Survey no. 2[38]) or schist. The structures that had simple rammed-earth corners were strong enough to meet the required reinforcement needs owing to the good quality soil (Survey no. 1[1]).

Fired-brick eaves were also observed (Survey nos. 1[1], 2[38]).

Buttresses and tie-rods

There were no buttresses or tie-rods in the studied buildings. There are two plausible reasons for this. Firstly, the rammed-earth walls were very strong and did not need reinforcement. Secondly, the Alentejo region is considered less seismic, with an average maximum intensity scale of V (international scale). So the rammed-earth walls do not require added materials to reinforce them.

8.1.2. 'REGION B' — REDONDO, ÉVORA

Location (village / nearest village)

Aldeia de Montoito — Survey nos. 3[9], 4[10], 5[11].

Construction technique(s)

Rammed-earth — Survey nos. 3[9], 4[10] (original building and annex), 5[11].

Rammed-earth dimensions

1.47m x 50cm (two layers) — Survey no. 3[9].

1.50m x 45cm (two layers) — Survey no. 4[10].

1.50m x 45cm (one layer) — Survey no. 4[10] (annexe).

1.60m x 50cm (two layers) — Survey no. 5[11].

Exterior wall thickness

54cm — Survey no. 3[9].

47cm — Survey nos. 4[10], 5[11].

57cm — Survey no. 4[10] (annexe).

Soil types

- Sr i.e. Red or yellow Mediterranean soils, clayey with deposits — Survey no. 4[10].
- Pac+Vcm i.e. Grey Mediterranean soils, marly limestone or marls + Red or yellow Mediterranean soils, marly limestone or marls — Survey nos. 3[9], 5[11].

Walls

Each of the houses studied in this region displayed different 'lift' dimensions, and the wall thickness varied from 47-57cm. However, there were two layers in each rammed-earth block in all the buildings analysed in this region (Survey no. 3[9], 4[10] — original building, 5[11]).

Building typology

In the centre of Aldeias de Montoito and its surrounding area, the buildings displayed a typology with two rammed-earth layers within each block, separated by a layer of mortar + fired-brick + mortar (Survey no. 3[9], and almost every building that was without plaster in the village centre). If the owners of the building had limited resources, the typology was kept the same, but the brick was replaced with schist (Survey no. 5[11]), or with a mixture of both materials (Survey no. 4[10] — original building).



Image 172: Two rammed-earth layers within each block, separated by a layer of mortar + fired-brick + mortar (Survey no. 3[9]).

The rammed-earth construction in Survey no. 4[10] — original building and annex, displayed two different kinds of typologies. The original building had the same typology as Survey no. 3[9] i.e. two rammed-earth layers per block, separated by a layer of mortar + fired-brick or schist + mortar. The annex however, did not have mortar or brick/stone courses. The block dimensions of the two typologies were the same: 1.50m x 45cm. The masons at that time knew the varieties of earth well and adapted the rammed-earth constructions accordingly. Survey no. 4[10] is an interesting example to analyse. The earth used for both rammed-earth typologies is different from that used in the other buildings analysed in the region: the texture is more clayey with non-calcareous materials and deposits. It seemed that in the original building, in order to compensate for the lack of course grain in the earth used, pieces of fired-bricks, tiles and small stones were added to the earth mixture, but the rammed-earth typology was kept the same. The annex was built 30-40 years later, probably by a different mason. The hypothesis is that he might have understood that this earth did not require brick/schist horizontal courses in order to bear stable walls.

The earth mixture used to construct the other buildings (Survey nos. 3[9], 5[11]) contained a large concentration of quartz fragments. One of the masons in the region explained that in order to have strong rammed-earth walls, it was important to add small, brown stones that are naturally found in the region. These stones are popularly called '*escumalhada de ferro*' (type of 'iron slag') by the villagers.

The rammed-earth in this region i.e. 'Region B' was weaker than that found in 'Region A'. In this region, the soil particles were rounder (which fall-off easily) as compared to the sharper soil particles in 'Region A'. Yet, there were a number of houses all across 'Region B' that never had a plaster, but were still in good condition. In this region, showed structures showed evidence of an earth based wash (Survey nos. 3[9], 5[11]), and some did not show any plaster.

Base-course and corners

A base-course was present in almost all the analysed buildings. The base-course was constructed with schist and/or granite (Survey no. 3[9]), or different types of natural and artificial stones (Survey no. 4[10]).

The corners were built with fired-bricks (Survey no. 3[9]), stone and fired-bricks (Survey no. 4[10]), or rammed-earth and fired-bricks (Survey no. 5[11]).

Survey no. 3[9] had fired-brick eaves that formed the roof over-hang. It was interesting to observe that the earth used for the fired-bricks included quartz, which was similar to the composition of the rammed-earth walls (Survey no. 4[10]).

Buttresses and tie-rods

Buttresses were present only in Survey no. 3[9]. This was also the only building that had arches, as well as big, thick walls. Tie-rods were observed in the walls of all the three buildings analysed in this region (Survey nos. 3[9], 4[10], 5[11]).

8.1.3. 'REGION C' — MOURÃO, ÉVORA

**The village of 'Aldeia da Luz' was submerged under water in around 2002 to make way for the Alqueva Dam. A new village called 'Luz' was created nearby for the displaced inhabitants. While the original village and its houses cease to exist, the people who inhabited them still live, and so do memories of 'Aldeia da Luz'...*



Image 173: Old village, 'Aldeia da Luz'.

[Source: Museu da Luz, *Arqueologia nas Terras da Luz*, 2004]

Image 174: Old village, 'Aldeia da Luz'.

[Source: Photo-frame found at a residence in the new village, 'Luz']



Image 175 and Image 176: New village, 'Luz', 2018.

Location (village / nearest village)

Aldeia da Luz — Survey nos. 6[14], 7[39], 8[40].

Construction technique(s)

Rammed-earth — Survey nos. 6[14], 7[39], 8[40].

Adobe-bricks — Survey nos. 7[39] (between rammed-earth 'lifts'), 8[40] (gables).

Rammed-earth dimensions

1.65m x 50cm — Survey no. 6[14].

1.70m x 50cm — Survey no. 7[39].

1.50m x 50cm — Survey no. 8[40].

Adobe-bricks dimensions

30cm (length) x 17cm (width) x 8cm (height) — Survey no. 7[39].

33cm (length) x 16cm (width) x 10cm (height) — Survey no. 8[40].

Exterior wall thickness

50cm — Survey no. 6[14].
47cm — Survey no. 7[39] (west wall).
42cm — Survey no. 7[39] (east wall).
40cm — Survey no. 8[40].

Soil types

- Px i.e. Grey Mediterranean soils, with schist or greywackes — Survey nos. 6[14], 7[39], 8[40] (first rammed-earth layer).
- Ex i.e. Lithosoils, with schist or greywackes — Survey no. 8[40] (second rammed-earth layer).

Walls

The rammed-earth block varied in length from 1.50-1.70m. The height stayed uniform: 50cm. The wall thickness varied from 40-50cm.

Building typology

The rammed-earth typology in this region revealed some interesting findings. Schist was present between the first two rammed-earth 'lifts' (Survey nos. 6[14] and 8[40]). Even though, in Survey no. 8[40], there were only two rammed-earth 'lifts', there was schist between them; schist was also present between the second rammed-earth 'lift' and the adobe-bricks along the top of the walls. In both cases, Survey nos. 6[14] and 8[40], an earthen mortar was found between the rammed-earth and schist (mortar below schist). The building in Survey no. 7[39] had adobe-bricks between the rammed-earth 'lifts'. They were hard to spot as they camouflaged with the monolithic walls.

Adobe-brick was another technique used in this region. This could be attributed to the availability of clayey soil in the region. In the village centre, adobe-bricks were used in exterior as well as interior walls. They were also used in gables (Survey no. 8[40]). In the latter case, a schist course was placed on the top of the wall to ease the roof weight on the adobe-bricks. There was earthen mortar between the adobe-bricks and the schist. In cases where the adobe-bricks were cut in order to accommodate the slopes of the roof, schist gravel was observed in the bricks. This was probably done to prevent the adobe-bricks from crushing under the weight of the roof.

Many of the buildings in this region were plastered, which made it very difficult to identify the construction techniques. In addition to earthen buildings, schist constructions are known to have existed in this region. In reality, the rammed-earth and adobe-brick techniques were not often considered appropriate for construction because in the area around Aldeia da Luz there were risks of the buildings disappearing under water. Yet, there are examples of un-plastered buildings (Survey no. 8[40]), and part of the building of Survey no. 6[14] or buildings with an earth wash (Survey no. 7[39], and the other part of Survey no. 6[14]).

When the new village was being planned i.e. before 2000, a request by several of the inhabitants was to cover their new houses with schist. However, when visited in 2018, the residents who now live in the new village, 'Luz' spoke fondly of their earthen houses in the old village, 'Aldeia da Luz'. They said that the rammed-earth building incurred almost no damages and required little maintenance, as compared to their current houses in the new village.

This was the only region among those surveyed in Alenetjo for this study, where some owners have built their own structures (Survey nos. 7[39], 8[40]). One of the residents, Antonia mentioned that masons ('pedreiros' in Portuguese) usually built the buildings; smaller structures such as chicken coops were sometimes built by the owners themselves.

Base-course and corners

All the analysed buildings had a base-course. It was either in schist and granite (Survey nos. 6[14], 8[40]), or simply in schist (Survey no. 7[39]).

The corners were rammed-earth (Survey nos. 6[14], 7[39]), or in rammed-earth and schist (Survey no. 8[40]).

Buttresses and tie-rods

Only one building had buttresses; they were in schist (Survey no. 6[14]). No tie-rods were spotted in the studied buildings. Wooden rafters extended from the exterior walls of one of the buildings (Survey no. 7[39]).

8.1.4. 'REGION D' — MOURA, BEJA

**The rammed-earth building in Survey no. 9[18] was lost in a fire, and is rebuilt in cement.*

Location (village / nearest village)

Safara — Survey nos. 9[18], 10[19].

Construction technique(s)

Rammed-earth — Survey nos. 9[18], 10[19].

Rammed-earth dimensions

1.60m x 55cm (one layer) — Survey no. 9[18].

Undetermined — Survey no. 10[19].

Exterior wall thickness

50cm — Survey no. 9[18].

55cm — Survey no. 10[19].

Soil types

- Sr i.e. Red or yellow Mediterranean soils, clayey with deposits — Survey nos. 9[18], 10[19].

Walls

In this region, there were numerous rammed-earth buildings. The people who were interviewed reiterated that in the 'montes,' the owners' houses were built in stone, and the workers' quarters were built in rammed-earth for economic reasons. All the un-plastered buildings observed in the region, even the big houses that belonged to landowners were in rammed-earth. The materials used in construction were those that were easily available in the region, with which the masons were well acquainted.



Image 177 and Image 178: In Safara, even the big houses that belonged to landowners were in rammed-earth.

[Source: Correia, *Le pise d'Alentejo, Portugal*, 2000]

The wall thickness of the structures in the village and area surrounding Safara was typically 50-55cm (Survey nos. 9[18], 10[19]). In Survey nos. 9[18] and 10[19], the earth consisted was fine soil particles, and was well-compacted. It was the same kind of soil and rammed-earth typology as in Survey no. 4[10] — annex building.

Building typology

Both the analysed buildings constituted 'Sr' type soil and had an earthen mortar between the rammed-earth layers. Even the openings left by wooden beams were filled with mortar because the earth used had fine soil particles. The buildings in this region were generally plastered (Survey nos. 9[18], 10[19]).

Base-course and corners

It both the analysed buildings, it was difficult to determine its existence of a base-course (Survey nos. 9[18], 10[19]). However, evidence of a stone base-course was found in Survey no. 9[18].

As for the corners, instead of using other reinforcement materials, the rammed-earth blocks were overlapped (Survey no. 9[18]. In Survey no. 10[19], it was not possible to determine the materials and techniques used to reinforce corners. In addition, fired-brick and schist corners were observed in some structures in the region.

Buttresses and tie-rods

Both the buildings surveyed in this region had buttresses and tie-rods (Survey nos. 9[18], 10[19]). However, most of the buildings surveyed in this region by Mariana did not have buttresses. It was also observed that the buildings that did not have horizontal reinforcements between the rammed-earth 'lifts' were the ones with tie-rods.

8.1.5. 'REGION E' — SERPA, BEJA

Location (village / nearest village)

Vales Mortos — Survey nos. 11[25], 12[27].

Construction technique(s)

Rammed-earth — Survey nos. 11[25], 12[27].

Rammed-earth dimensions

1.50m x 50cm (one layer) — Survey no. 11[25].

Cannot be determined — Survey no. 12[27].

Exterior wall thickness

50cm — Survey nos. 11[25], 12[27].

Soil types

- Vx i.e. Red or yellow Mediterranean soils, with schist — Survey nos. 11[25], 12[27].

Walls

The dimensions of the rammed-earth blocks of the buildings surveyed in this region was 1.50m x 50cm (Survey nos. 11[25], [26]). The dimensions could not be determined in Survey no. 12[27] as the building was plastered.

Building typology

The earth used to build the structures in this region was the same as in 'Region A'. This soil is very good for rammed-earth constructions. The masons in this region had a rich understanding of rammed-earth techniques, and some of them use it even today (Survey no. 12[27]).



Image 179: Builder of 'Monte dos Sobreiros' (Survey no. 12[27]),
Mason António Martins Inácio, and his wife at their residence in Vale Mortos.

[Photo credits: Rui Cambraia]

The rammed-earth typology presented a simple rammed-earth walls i.e. without horizontal reinforcements, while others had rammed-earth 'lifts' separated by earth and lime mortar (Survey no. 11[25], and most buildings in Vales Mortos village). One of the region's interesting details was the presence of fired-bricks in different parts of the building, including in the door jambs and window frames.



Image 180: Rammed-earth 'lifts' separated by earth and lime mortar (Survey no. 11[25]).

It was interesting to note that in spite of the existence of stone in the area and its use in some compound walls, the buildings were built in earth. The rammed-earth was quite strong which explains the absence of plaster on most of the walls of the buildings meant for the animals. Only the facades facing the road had a plaster (Survey no. 11[25]). Survey no. 12[27] is a recent construction and is plastered on all sides.

The research conducted in 2000 makes it evident that the inhabitants of this region vouched for rammed-earth constructions. However, when visited in 2018, the owner of Survey no. 11[25] said that he would like to reconstruct his building with bricks as he has no confidence in rammed-earth buildings.

Base-course and corners

Sometimes the base-course was built with fired-bricks (part of the building in Survey no. 11[25]), and sometimes with schist (Survey no. [26]). In the case where no base-course was found, there probably was a foundation (Survey no. 12[27]).

The corners were made of rammed-earth and fired-bricks (Survey no. 11[25]), stone (Survey no. 12[27]). There were others built with rammed-earth and stone.

Buttresses and tie-rods

Neither of the surveyed buildings had buttresses or tie-rods (Survey nos. 11[25], 12[27]). One of the buildings (out of four) analysed by Mariana had buttresses that were added later. This was probably because the rammed-earth corners were not reinforced with other materials.

8.2. CONSTRUCTION DETAILS — ALENTEJO

As in the case of Goa, the case-studies conducted in Alentejo are analysed based on the following aspects.

- Soils, construction techniques and building typology.
- Construction details.
- Mortars, plasters, pigments and/or paints.

8.2.1. SOILS, CONSTRUCTION TECHNIQUES AND BUILDING TYPOLOGY

Portugal has a wide variety of soils. The variety increases even more in the south of the country. The rammed earth quality depends a lot on the kind of soils used, their properties and of the aggregates added to them.

The buildings were classified according to the regions they were located in and the **soil types** they were built with. Those located in a zone with two kinds of soils, the classification was done twice.

- Vx i.e. Red or yellow Mediterranean soils, with schist ('Region A' — Survey no. 1[1]; 'Region E' — 11[25], 12[27]).
- Pmg i.e. Grey Mediterranean soils, with quartzitic diorites ('Region A' — Survey no. 2[38]).
- Pac+Vcm i.e. Grey Mediterranean soils, marly limestone or marls + red or yellow Mediterranean soils, marly limestone or marls ('Region B' — Survey nos. 3[9], 5[11]).
- Sr i.e. Red or yellow Mediterranean soils, clayey with deposits ('Region B' — Survey no. 4[10]; 'Region D' — 9[18], 10[19]).
- Px i.e. Grey Mediterranean soils, with schist or greywackes ('Region C' — Survey nos. 6[14], 7[39], 8[40] (first rammed-earth layer)).
- Ex i.e. Lithosoils, with schist or greywackes ('Region C' — Survey nos. 8[40] (second rammed-earth layer)).

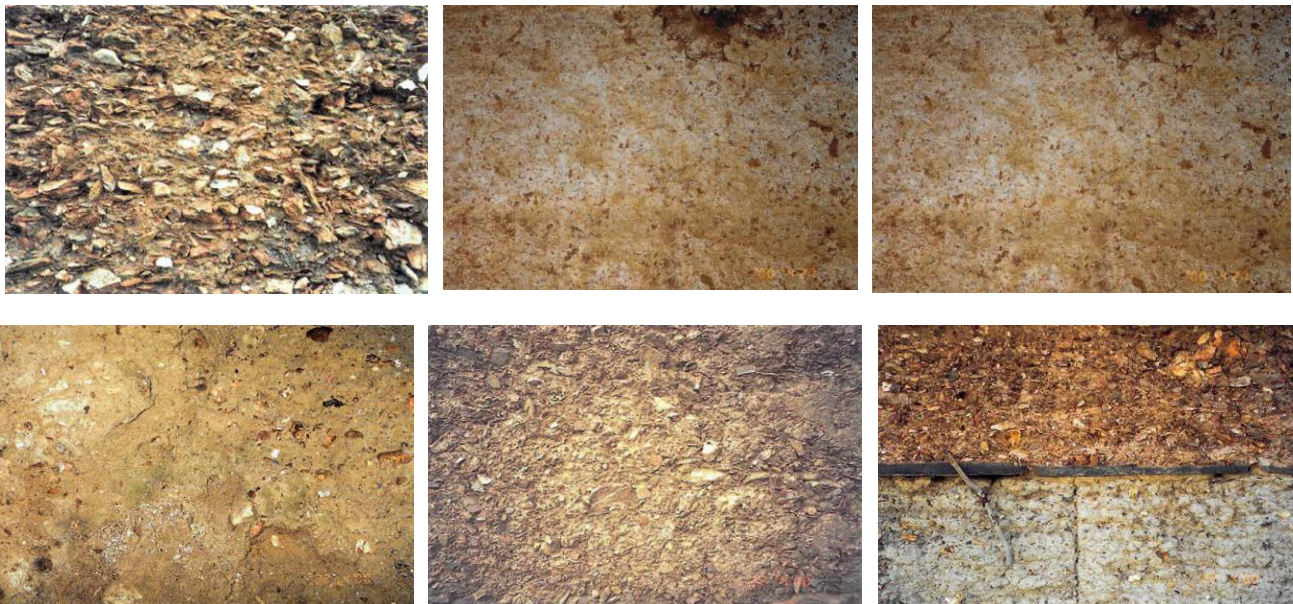

Image 181: Vx i.e. Red or yellow Mediterranean soils, with schist (Survey no. 11[25]).

Image 182: Pmg i.e. Grey Mediterranean soils, with quartzitic diorites (Survey no. 2[38]).

Image 183: Pac+Vcm i.e. Grey Mediterranean soils, marly limestone or marls + Red or yellow Mediterranean soils (Survey no. 3[9]).

Image 184: Sr i.e. Red or yellow Mediterranean soils, clayey with deposits (Survey no. 10[19]).

Image 185: Px i.e. Grey Mediterranean soils, with schist or greywackes (Survey nos. 6[14]).

Image 186: Ex i.e. Githosoils, with schist or greywackes (Survey no. 8[40] — second rammed-earth layer).

[Source: Correia, *Le pise d'Alentejo, Portugal*, 2000]

Two **earth construction techniques** were identified.

- Rammed-earth
(All 12 case-studies: 'Region A' — Survey nos. 1[1], 2[38]; 'Region B' — 3[9], 4[10], 5[11]; 'Region C' — 6[14], 7[39], 8[40]; 'Region D' — 9[18], 10[19]; 'Region E' — 11[25], 12[27]).

- Adobe-bricks
(Three case-studies: 'Region A' — Survey no. 1[1] (internal walls); 'Region C' — Survey nos. 7[39] (between rammed-earth 'lifts', 8[40] (gables)).



Image 187: External walls in rammed-earth and internal walls in adobe-bricks (Survey no. 1[1]).

The **typology** differed from region to region.

- 1) In 'Region A', Telheiro (Survey no. 1[1]) and 'Region E', Vales Mortos, (Survey nos. 11[25], 12[27]), the rammed-earth buildings were built with Vx type soil. The earth had a lot of schist with enough clay, which allowed for good compaction of the rammed-earth walls. The typology was simple in 'Region A' (Survey no. 1[1]), or with mortar between the rammed-earth 'lifts' in 'Region E' (Survey no. 11[25]).

The type of soil found in these regions is good for producing quality rammed-earth constructions, which eliminate the need of a lime plaster. Nonetheless, plasters are often used on front facades or facades with openings. In general, the inhabitants of these regions were proud of their rammed-earth building traditions, especially in 'Region E', where masons still build in rammed-earth.

- 2) 'Region A', São Pedro do Corval (Survey no. 2[38]), and its surroundings is where Portugal's biggest concentration of potters can be found. This can be justified by the fact that Pmg type soil, which is very clayey is found in this region. This also explains the frequent use of fired-bricks in the buildings. Some years ago, a fired brick oven dating to the Roman period was discovered close to the building featured in Survey no. 2[38].

Survey no. 2[38] was the only structure analysed in this region. It had some walls built in fired-brick masonry, as well as a course of mortar + fired-brick between the rammed-earth 'lifts'. One can also find an earth wash in the rammed-earth of the inside walls.

- 3) 'Region B', Aldeias de Montoito (Survey nos. 3[9], 5[11]) has a soil mixture of Pac+Vcm. This earth presents a high concentration of quartz. Small brown pebbles called 'escumalnada de ferreiro' (type of iron slag) by the local masons is naturally found in this soil. The rammed-earth walls have two layers per block, separated by a layer of mortar (Survey no. 5[11]), or mortar + fired-brick + mortar (Survey no. 3[9]). If the owner had limited resources, the bricks were replaced with schist. The rammed-earth in the 'Region B' (Pac+Vcm soil) is weaker than the one in 'Region A' (Vx soil), in that it has rounder soil particles (which fall-off easily) — unlike the soil in 'Region A', which has sharper soil particles. Yet, in Aldeias de Montoito, there exist structures that are decades old and have never received a coat of plaster. It is the layers of mortar and fired-bricks or schist between the rammed-earth 'lifts' that allow for well-consolidated and long-lasting walls.
- 4) 'Region B', Aldeias de Montoito (Survey no. 10[19]) also has Sr type soil, which is much less clayey (with non-limestone materials and deposits). The walls have a single rammed-earth layer per block, without any mortar or other materials. It is a simple rammed-earth typology, which needs good compaction.

This soil type and typology exists in 'Region D', Safara (Survey nos. 9[18], 10[19]).

- 5) 'Region C', Aldeia da Luz (Survey nos. 6[14], 7[39] 8[40] (first 'lift' only)) had Px type soil. It comprised soil particles that were fine and had sharp corners. The walls had large greenish schist stones between the rammed-earth 'lifts' (Survey nos. 6[14] — only between first and second rammed-earth 'lifts', 8[40] — which had only two 'lifts'). Survey no. 7[39] had adobe-bricks, and no other materials as horizontal courses between the 'lifts'. This building also had a schist course along the top of the wall.
- 6) Survey no. 8[40] (second layer), comprised Ex type soil. It contains fine grain rock fragments and has a weak clay concentration. Though the soil includes a lot of greywackes, the schist present in it is also visible clearly. The reddish colour of the earth maybe because of the presence of fine and clayey, greyish and reddish schist. A laboratory analyses would be required to confirm the same.
- 7) Adobe-bricks were observed in 'Region A', Telheiro (Survey no. 1[1] — internal walls), and 'Region C', Aldeia da Luz (Survey no. 7[39] — between rammed-earth 'lifts,' Survey no. 8[40] — gables). In 'Region C', the presence of adobe-bricks is evidence that this material was used for horizontal reinforcements, as a substitute for schist and fired-brick. Adobe-bricks were often used in the region in exterior and interior walls, or as gable filling as clayey soil, apt for making such these bricks was found in the region.

8.2.2. ARCHITECTURAL ASPECTS — ALENTEJO

- 1) The **dimensions** of the rammed-earth blocks varied. The length ranged from a minimum of 1.50m (Survey nos. 4[10], 8[40], 11[25]) to a maximum of 2.50m (Survey no. 1[1]), and the height from 45cm (Survey no. 4[10]) to 55cm (Survey nos. 9[18], 10[19]). The sizes of the adobe-bricks also differed:
 - 30cm (length) x 20cm (width) x 10cm (height) (Survey no. 1[1] — internal walls).
 - 30cm (length) x 17cm (width) x 8cm (height) (Survey no. 7[39] — horizontal courses).
 - 33cm (length) x 16cm (width) x 10cm (height) (Survey no. 8[40] — gables).
- 2) Though in most cases the **external wall thickness** of the rammed-earth walls was 50cm (Survey nos. 1[1], 2[38], 6[14], 9[18], 10[19], 11[25], 12[27]), it varied from 40cm (Survey no. 8[40]) to 57cm (Survey no. 4[10] (annexe)).
- 3) Wherever it was clearly visible, it was observed that base-course were in stone and/or fire-brick. Eight (out of 12) buildings analysed for this study had a stone **base-course** (Survey nos. 1[1], 3[9], 5[11], 6[14], 7[39], 8[40], 9[18], 11[25]). Base-courses built with both, stone and fired-bricks were also found (Survey nos. 2[38], 4[10], 11[25]). In addition, in the Alentejo region, there exist rammed-earth houses with no base-courses.

Stone and/or fired-brick base-courses helped in avoiding capillary rise, and preventing rainwater and humidity from entering earthen walls.

In one building it was possible to confirm the existence of a foundation (Survey no. 12[27]).

- 4) The **corners** were built in rammed-earth (Survey nos. 1[1], 6[14], 7[39], 9[18]), rammed-earth and fired-bricks (Survey nos. 5[11], 11[25]), rammed-earth and stones (Survey no. 8[40]), or fired-brick (Survey nos. 5[11], 3[9]), fired-brick and stone (Survey no. 4[10]), or stone (Survey no. 12[27]). It is important to note that the four buildings with rammed-earth corners (Survey nos. 1[1], 6[14], 7[39], 9[18]) were either built with good quality earth or the 'lifts' were well-compacted. In some cases, it was observed that the rammed-earth 'lifts' overlapped each other in the corners, thereby strengthening the corners.

In cases where the corners were built with rammed-earth and fired-brick or stone, the latter materials acted as liaisons but more so, they prevented the degradation of walls which usually begins at the corners.

- 5) There are some structures observed in 'Region D', Safara, which have an **L-shaped element at the corners**, inside the rammed-earth walls. This provided additional reinforcement, especially that Safara is close to a seismic zone of maximum intensity VII (international scale).

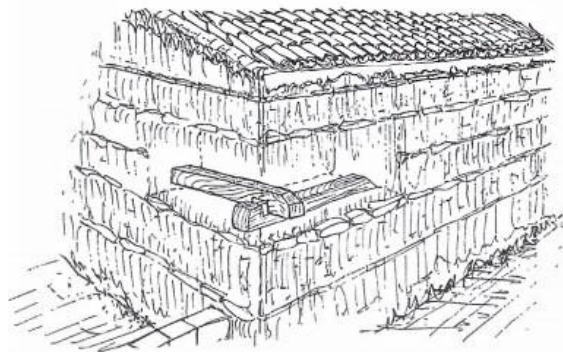

Image 188: L-shaped element at the corners, inside the rammed-earth walls.

[Source: Correia, *Le pise d'Alentejo, Portugal*, 2000]

- 6) Rammed-earth walls are more sensitive to roof weight than stone or brick walls. In order to prevent the damage of walls owing to roof weight, **tie-rods** fitted with iron-rods inside it were used to stabilise walls. **Buttresses** also help in securing wall stability. Out of the 12 analysed buildings, six had tie-rods (Survey nos. 3[9], 4[10], 5[11], 9[18], 10[19]), and four had buttresses (Survey nos. 3[9], 6[14], 9[18], 10[19]). Most of the buttresses were mainly built with stone, except Survey no. 3[9], which also included fired-brick.
- 7) In some walls, the rammed-earth blocks have **slanting joints**. This allows one block to rest on the one that follows along the same 'lift' allowing for better joinery (Survey nos. 9[18], 11[25] — some joints).
- 8) Walls built with soils comprising fine soil particles usually had the **holes left by the rammed-earth form-work covered with mortars** (Survey nos. 9[18], 10[19]).

- 9) 'Region E', Vales Mortos is characterised by the use of **fired-bricks in rammed-earth walls**, especially along the frames of doors and windows. Fired-bricks are also seen along corners, between rammed-earth 'lifts'.
- 10) When there were rammed-earth 'lifts' built with different soil types (Survey no. 8[40]), or if the 'lifts' were built during different time periods, an attempt was made to **separate the 'lifts' by using added materials** such as stones, mortar, or mortar + fired-brick + mortar. This helped in avoiding problems likely to arise, in case the two materials are not compatible.
- 11) Five buildings displayed **overhangs**. In most cases, the material used was thin fired-brick ('*tijolo cozido*' in Portuguese) (Survey nos. 1[1], 2[38], 3[9], 7[39]). There was one case with schist (Survey no. 8[40]). This simple overhang was enough to protect the top of the walls from moderate rains. The presence of schist on the top of the walls could have had many purposes: to level the wall before placing the roof on it, to provide structural support to the triangular roof truss, to act as a barrier and avoid contact between the rammed-earth and the wood, etc.



Image 189: Fired-brick overhangs.
[Source: Correia, *Le pise d'Alentejo, Portugal*, 2000]

- 12) Sometimes, the **spaces left between the rammed-earth blocks** created openings which allowed light to enter the inside of the building.

8.2.3. MORTARS, PLASTERS, RENDERS, PIGMENTS AND/OR PAINTS

Earth or lime **mortars** were used in rammed-earth walls.

- Along horizontal joints i.e. between the rammed-earth 'lifts', which in some cases also contained fire-brick (Survey nos. 2[38], 3[9], 4[10], 5[11], 8[40], 9[18], 11[25]).
- Along vertical joints (Survey nos. 3[9], 5[11]).
- Between the rammed-earth wall and wooden rafters (Survey nos. 1[1], 2[38], 5[11], 7[39], 8[40]).
- Between the top of the rammed-earth wall and the overhang (Survey nos. 1[1], 2[38], 5[11], 7[39], 10[19]).
- Mortars were also used to fill holes left by the rammed-earth form-work (Survey nos. 9[18], 10[19]).

In most of the analysed buildings in Alentejo, only the facade walls had **plasters, pigments and/or paints** (Survey nos. 1[1], 2[38], 3[9], 4[10], 5[11], 9[8], 10[19], 11[25]). Survey no. 12[27], which is a new construction had all its walls plastered.

Secondary buildings such as annexes used for agricultural reasons, or buildings for housing animals, often received an inferior quality plaster treatment (Survey nos. 1[1] — agricultural annexes; 2[38] — interior walls of pottery shop, no plaster; 6[14] — animal shed, clay and lime wash; 7[39] — animal shed, thin layer of earth plaster; 8[40] — animal shed, no plaster; 11[25] — animal shed, only some walls plastered). Survey no. 9 ('Region D') was an exception as it was originally a cow shed but was later used for storing farm machinery.

Seven (out of the 12) buildings surveyed had lime plaster or lime-wash (Survey nos. 1[1], 2[38], 3[9], 4[10], 5[11], 6[14], 11[25]).

It was also common to find earthen plasters and earth-wash (Survey nos. 3[9], 4[10], 5[11], 6[14], 7[39], 9[18]).

In three cases, cement plaster was found (Survey nos. 9[18], 11[25], 12[27]). Survey no. 12 is a new construction and all the walls were plastered with cement.

All the houses that were lime washed or painted were white. Some had blue highlights along the external wall-bases (Survey nos. 2[38], 4[10], 10[19]), and/or along door and window frames (Survey nos. 4[10], 12[27]). Survey no. 3[9] had blue daubs on its white, interior walls. (In 2000, Survey no. 4[10] had a yellow wall-base on the front facade. Survey nos. 10[19] and 12[27] were plain white.)



Image 190: Blue highlights along the external wall-bases, 2018 (Survey no. 10[19]).



Image 191: Blue highlights along door and window frames, 2018 (Survey no. 12[27]).

In Alentejo, walls were whitewashed periodically, usually by the women in the family (Survey no. 1[1]). However, few said that men also participated (Survey no. 2[38], Mason António Martins Inácio ('Region E')). Today, workers are sometimes hired for the same (Survey no. 2[38]).

As Tania Teixeira (Architect, Montemor-o-Novo) and Joaquim Baptista (Mason-Sailor, Mourão) explained, lime ('cal' in Portuguese) used to be made by burning limestones in a kiln. Two main types of lime were found in the region.

- White-lime ('cal branca' in Portuguese)
- Black-lime (referred to as 'cal preta', 'cal parda', 'cal de obra' or 'cal morena' depending on the master-builder ('mestre') or region).

The colour and shade of black-lime varied according to the region, batch of stones, etc. Even in the same kiln, different colours and shades of were seen.

New rammed-earth walls usually had two layers of plaster. The one below was made with black-lime (and coarse sand particles), and the finishing layer was made in white-lime (and fine sand particles). The layer below was thicker than the one above. Black-lime was fired at a lower temperature and was cheaper than white-lime.

Paulina Faria (Architect, Lisbon) related that sometimes, after completing the construction of the house and the roof, the owners would wait for about a year to plaster, render, and/or paint the building. This would allow ample time for the rammed-earth walls to dry, permit necessary erosion of wall surfaces to facilitate adhesion of the plaster treatments, as well as would delay costs. In some cases, houses were not plastered, and paints were applied directly.

Inhabitants across Alentejo communicated that before, houses used to be painted in ochre, red, grey, or blue. The ochre and red were pigments found naturally in soil. Grey was collected from the ashes and soot from chimneys (It was called '*pó de sapato*' in Portuguese, which could be translated to 'powder for shoes'. It probably got its name because it was might have been used to polish shoes as well). The pigments were mixed with lime and applied to walls. In kitchens, ochre was preferred over white so as to prevent smoke from blackening the walls.

As related by Joaquim Baptista (Mason-Sailor), in Mourão, ochre pigments were got from the village field that belonged to the municipality, and to which the villagers had open access (such a field was called '*baldio*' in Portuguese). Other colours, such as blue were bought in powder form from the shop ('*drogaria*' in Portuguese). The name of the brand was 'Anil'.

In Sobral Da Adiça, Beja, there is an open mine where at certain depth, a layer of ochre is found.

As Carla Luz (Architect, Municipality of Mourão) explained that in the last 60-70 years however, people switched from painting exterior walls in colours to covering them in white only. And about 30-40 years ago, this shift from coloured to white walls was seen on interior walls as well.



Image 192: Coloured and white interior walls seen in the ruins of an earth building. Mourão, Évora, 2018.

In Alentejo, it was customary to whitewash houses annually, usually before the feast of one's village. As Paulina and others explained, this action was more of a cultural norm, rather than an activity with technical implications. It was a cleaning and social affair. Those who did not whitewash their walls were considered to be less clean. Some people also mixed a product called '*cloro*' with water, and applied it to the walls before whitewashing them. This was primarily meant to disinfect walls, kill any fungal-growths, etc. It probably also helped with the adhesion of the new layer of whitewash.

Traditionally, lime was made from limestone (this lime is called 'cal' in Portuguese), and walls were whitewashed every 1-2 years. This created many paint layers, and thickened the walls over the years. Today, people prefer paints ('tinta' in Portuguese), and they walls are repainted rarely.



Traditionally, walls were whitewashed every 1-2 years. This created many paint layers, and thickened the walls over the years.
Image 193: Wall in Moura, Beja, 2018. Image 194: A ruin of a house in Serpa, Beja, 2018.

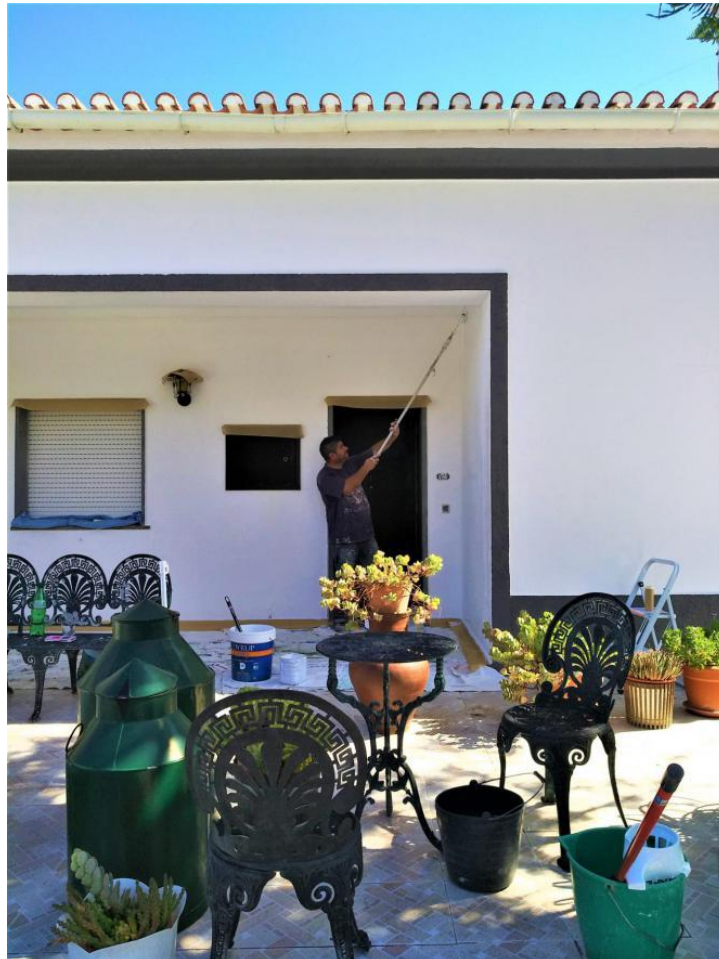

Image 195: Today, many white wash their walls with paints ('tinta' in Portuguese). Mourão, Évora, 2018.

Plasters, renders, pigments and/or paints reflect the sun's rays, as well as protect walls.^[285]

²⁸⁵ Correia, *Taipa no Alentejo. Rammed Earth in Alentejo*, p.154

8.3. CONSERVATION APPROACHES — ALENTEJO

8.3.1. DAMAGES INCURRED, PROBLEMS AND CHALLENGES FACED

- 1) Some structures are in **ruins** ('Region B' — Survey nos. 3[9], 4[10]; 'Region E' — Survey no. 11[25]).
- 2) There is **vegetation** on, in and around the building ('Region B' — Survey nos. 3[9], 4[10]; 'Region E' — Survey no. 11[25]).

Roof:

- 3) Roof or part of the roof was once **lost in a fire** ('Region A' — Survey no. 2[38]; 'Region D' — Survey no. 9[18] (metal roof)).
- 4) A storm once brought down the chimney and created an **opening in the roof** ('Region D' — Survey no. 10[19]).
- 5) Winds tend to **destabilise the roof**, especially that the roof spans-out and is big in size ('Region D' — Survey no. 10[19]). Winds also tend to **dislocate roof-tiles**, sometimes causing them to fly-off the building ('Region A' — Survey no. 2[38]; 'Region D' — Survey no. 9[18]).
- 6) During the monsoons, old roof-tiles become so fragile that even a cat walking on damp tiles could cause **cracking of roof-tiles** ('Region A' — Survey no. 2[38]).
- 7) Rotting of **roof framework** ('Region A' — Survey no. 1[1]).

Walls:

- 8) The building was lost in a **fire** ('Region D' — Survey no. 9[18]).
- 9) In Survey no. 11[25] ('Region E'), the owner said that the structure did not have a roof for many years, the walls were exposed to rainwater and parts of the **walls have fallen**.
- 10) **Cracks** were observed on most of the visited buildings ('Region A' — Survey nos. 1[1], 2[38]; 'Region B' — Survey nos. 3[9], 4[10]; 'Region D' — 9[18]), 10[19]; 'Region E' — Survey nos. 11[25], 12[27]. These cracks ranged from surface cracks on plasters to structural cracks.

In Survey no. 1, the owners reported that cracks sometimes appeared on walls, but rarely on plasters. Cracks were particularly observed in corners.

In Survey no. 4[10], the walls were exposed and the cracks led the building to fall apart.

In survey 12[27], a fine crack demarcates the old earth construction from the new extension.

- 11) **Holes** in walls, especially where there is lime plaster. The owner reported that the cows scratch the base of walls ('Region E' — Survey no. 11[25]).

Sometimes, cows like the salty taste of lime and hence they scratch and lick walls plastered with lime. If there is high salt content in the mud used in earthen buildings, they even lick walls with no plasters. Degradation of wall bases is often seen in cowsheds built with earth.^[286]

- 12) **Bee holes** ('Region B' — Survey no. 3[9]).
- 13) **Degraded and damaged fired-bricks** ('Region B' — Survey no. 3[9]; 'Region E' — Survey no. 11[25]).
- 14) **Degraded mortars** ('Region E' — Survey no. 11[25]).
- 15) **Warping and falling plasters** ('Region B' — Survey nos. 3[9], 4[10]; 'Region D' — Survey no. 10[19]).

²⁸⁶ PNRMCB, *Restaurer son Bâti en Terre*, p.10

16) **Graffiti** ('Region E' — Survey no. 11[25]).

Floors:

17) Some **floor-tiles have chipped-off** ('Region A' — Survey nos. 1[1], 2[38]; 'Region D' — Survey no. 10[19]).

8.3.2. MAINTENANCE AND REPAIRS

PREVENTIVE CONSERVATION

Roof:

1) When the roof was redone, **burnt oil from car engines was applied to the roof's framework** i.e to the eucalyptus rafters ('Region A' — Survey no. 1[1]).

As reported by many inhabitants in Alentejo, this was often done in case of new roofs, and was usually a one-time treatment.

In addition, various buildings typologies and architectural details contribute to the strength and longevity of rammed-earth buildings.

2) **Good compaction** of rammed-earth 'lifts' and corners (Refer section '8.2.1. Soils, Construction Techniques and Building Typology', point 1; '8.2.2. Architectural Details', point 4).

3) **Mortars, fired-bricks and/or schist as horizontal reinforcements** between rammed-earth 'lifts' (Refer section '8.2.1. Soils, Construction Techniques and Building Typology' (points 1, 2, 3, 5, 7); '8.2.2. Architectural Details', point 10).

4) **Thick wall widths** (Refer section '8.2.2. Architectural Details', point 2).

5) **Stone and/or fired-brick base-courses, corners, etc.** (Refer section '8.2.2. Architectural Details', points 3, 4, 9).

6) **L-shaped reinforcements in the corners** of rammed-earth walls (Refer section '8.2.2. Architectural Details', point 5).

7) **Slanting joints** (Refer section '8.2.2. Architectural Details', point 7).

8) **Overhangs** (Refer section '8.2.2. Architectural Details', point 11).

PERIODIC CONSERVATION AND REPAIRS

Roof:

9) The **roof needed to be cleaned** sometimes, especially to remove plants, moss, etc. that sprouted on it. This was usually done using a brush. ('Region A' — Survey no. 1[1]).

10) **Roof-tiles are rearranged and/or replaced**, as per need ('Region A' — Survey nos 1[1], 2[38]; 'Region B' — Survey no. 5[11]; 'Region D' — Survey nos. 9[18], 10[19]).

In Survey no. 2[38], the owner explained that the roof requires to be retouched at least twice a year. This is done before and after monsoons i.e. in October and May. It is cleaned, the retainer hooks and roof-tiles are realigned and damaged tiles are replaced.

11) The wood in the **roof's framework was repaired, reinforced and/or replaced**, as and when needed. ('Region A' — Survey no. 1[1], 2[38]; 'Region C' — Survey no. 8[40]; 'Region D' — Survey nos. 9[18], 10[19]).

In Survey 2[38], the wooden beams were replaced with steel ones.

Roof repairs were mainly done during the summers i.e. between May and September, when it was dry and least likely to rain.

Walls:

Mason Joaquim Antonio Baptista from Mourão ('Region C') mentioned that if the rammed-earth building is built with good quality earth, no problems occur, and the need for repairs do not arise. If some rammed-earth walls do incur holes or cracks, they can be repaired.

- 12) Mason Joaquim explained that to repair **holes** in a rammed-earth wall, a mix of earth + schist + roof-tile pieces is used as infill.

Mason António Martins Inácio from Serpa ('Region E') said that if there is a hole on a rammed-earth wall, it first needs to be dug-out and deepened a little more. It has to be then wetted with water, and similar soil used to build the wall needs to be rammed into the hole.

- 13) **Cracks** were filled-up with a mixture of sand + lime (3:1) ('Region A' — Survey no. 1[1]), sand + lime + cement (4:2:1) ('Region D' — Survey no. 9[18]).

Mason Joaquim said that in case of a crack, it is chiselled a little more, and widened. It is then filled-up with a mix of earth + schist + roof-tile pieces.

Antonia, a previous resident of 'Aldeia da Luz' and current resident of 'Luz' explained that when they used to make lime i.e. 'cal', the top part used to be watery. The thick lime that settled at the bottom was used to fill-up wall cracks ('Region C').

- 14) **Cement repairs** were observed in most buildings that attempted repairs in recent times.

It has been observed that it was used to raise wall heights ('Region A' — Survey nos. 1[1], 2[38]), and fix walls ('Region A' — Survey nos. 1[1], 2[38]); 'Region B' — Survey no. 5[11]; 'Region D' — 9[18], 10[19]).

Recent construction have included cement. In Survey no. 12[27] ('Region D'), the rammed-earth walls have cement plasters. In Survey no. 9[18], the building is rebuilt in cement blocks.

- 15) **Buttresses** ('Region B' — Survey nos. 3[9], 4[10], 5[11]; 'Region D' — Survey nos. 9[18], 10[19]), and/or **tie-rods** ('Region B' — Survey no. 3[9]; 'Region C' — Survey no. 6[4]; 'Region D' — Survey nos. 9[18], 10[19]) were added to some buildings in order to secure the structural stability.

- 16) Before, **walls were whitewashed with in lime** ('cal' in Portuguese) every year ('Region A' — Survey no. 2[38]), every 1-2 years ('Region A' — Survey no. 1[1]), etc. However, since about the last few years, paint ('tinta' in Portuguese) is being used ('Region A' — Survey no. 1[1], 2[38]; 'Region B' — Survey no. 4[10]), and walls tend to be repainted less frequently. In case of Survey no. 2[38], the building continues to receive its annual coat of white paint even today.

Usually, masons are hired to repair roofs and walls ('Region A' — Survey nos. 1[1], 2[38]; 'Region D' — Survey no. 9[18]). As a resident of Luz, Mourão ('Region C') mentioned, the masons know how to climb roofs without breaking the tiles. However, in instances where there are workers or tenants occupying the building, they tend to do the repair work themselves ('Region B' — Survey nos. 4[10], 5[11]).

Other problems and challenges:

- 17) In Survey no. 2[38] ('Region A'), it was reported that the **temperature inside the building was too cold in the winters and too hot in the summers.**

- 18) **Roof-tiles were stolen** ('Region E' — Survey nos. 11[25]).

Finally, it was observed that the earthen buildings in all the surveyed regions faced similar damages and problems. Maintenance and repairs methods employed for their upkeep stayed similar too.

8.3.3. FUTURE PLANS

Some owners did not have any specific plan for their buildings. Others shared that they would like to continue to use the structure as a pottery shop ('Region A' — Survey no. 2[38]; store farm machinery in the building as he is now doing ('Region D' — Survey no. 9[18]; reconstruct in fired-bricks ('Region E' — Survey no. 11[25]).

IV. CONCLUSION

9. COMPARATIVE ANALYSES — GOA AND ALENTEJO

Following the aims of this study, the earth buildings of Goa and Alentejo have been compared for their:

- Local buildings cultures
- Conservation methods employed in the upkeep of the structures

9.1. LOCAL BUILDING CULTURES

<u>GOA</u>	<u>ALENTEJO</u>
<p><i>*The houses selected for this study do not provide an overall picture of the houses of Goa in terms of their function, size, condition, etc. They were chosen purely because they had at least one wall without plaster, which was a criteria for this research.</i></p>	
<p>A. BUILDING FUNCTION</p>	
<p>Most of the houses surveyed in Goa were residences. As much of Goa's population was traditionally agrarian, houses served the dual purpose of a residence and granary. There often was a loft for stocking agricultural material.</p>	<p>The houses selected in Alentejo were either 'montes' (isolated houses on the top of hillocks, inhabited only during the summers, and used for agricultural reasons), or animal sheds.</p> <p>Those who owned 'montes' often had their principal house in the nearby village, where all the family lived for most of the year.</p>
<p>B. SOILS</p>	
<p>The soils found in Goa were obviously different from those found in Alentejo.</p>	
<p>The soils with which the buildings in Goa were built were classified into three categories, based on mere observation:</p> <ul style="list-style-type: none"> ◦ Yellowish soil; includes clay, sand, and rubble. ('Region A', Salcete — Survey nos. 1, 3a, 3b, 4, 5, 7, 8, 9, 10). ◦ Red, lateritic soil with lots of rubble. ('Region A' — Survey nos. 2, 6, 11; 'Region B', Sanguem (Neturlim) — Survey no. 15; 'Region C', Pernem — Survey no. 14). ◦ Yellow-brown-red soil, more clayey than sandy. ('Region B', Sanguem (Salgini) — Survey no. 12, 13). 	<p>The soils found in the earth buildings in Portugal were:</p> <ul style="list-style-type: none"> ◦ Vx i.e. Red or yellow Mediterranean soils, with schist. ('Region A', Reguengos de Monsaraz — Survey no. 1[1]; 'Region E', Serpa — 11[25], 12[27]). ◦ Pmg i.e. Grey Mediterranean soils, with quartzitic diorites. ('Region A' — Survey no. 2[38]). ◦ Pac+Vcm i.e. Grey Mediterranean soils, marly limestone or marls + red or yellow Mediterranean soils, marly limestone or marls. ('Region B', Redondo — Survey nos. 3[9], 5[11]). ◦ Sr i.e. Red or yellow Mediterranean soils, clayey with deposits. ('Region B' — Survey no. 4[10]; 'Region D', Moura — 9[18], 10[19]). ◦ Px i.e. Grey Mediterranean soils, with schist or greywackes. ('Region C', Mourão — Survey nos. 6[14], 7[39], 8[40] (first rammed-earth layer). ◦ Ex i.e. Lithosoils, with schist or greywackes. ('Region C' — Survey nos. 8[40] (second rammed-earth layer)).

C. EARTH CONSTRUCTION TECHNIQUES AND CONTEXT

Three construction methods were identified in Goa and two in Alentejo.

Earth construction techniques identified in Goa:

- **Rammed-earth** (called '*taip*' in Konkani (Goa's local language)).
(Two case-studies: 'Region B' (Salgini) — Survey nos. 12, 13).
- **Adobe-bricks** (referred to as '*box*').
(Two case-studies: 'Region A' — Survey no. 4 (gable and kitchen walls), 10 (extension)).
- **Cob** (without straw) ('*mathe ghor*', which literal translation to 'house built with earth').
(Eleven case-studies (out of 16): 'Region A' — Survey nos. 1, 2, 3a, 3b, 4, 5, 6, 7, 8, 9, 11; 'Region B' (Neturlim) — Survey no. 15).

In 'Region A', Salcete, laypeople and/or masons participated in the building process. All the inhabitants, including owner-builders spoken to, described the cob technique — the two adobe-brick buildings were exceptions. One mason, Bernardo Sequeira was interviewed in this region. He elaborated on all three techniques: cob, adobe-bricks and rammed-earth.

Salcete was selected for this study because it belongs to the 'Old Conquests' i.e. the regions seized by the Portuguese in the first few years of their arrival to Goa, between 1510-1543. The rest of Goa that was captured between 1763-1788 forms the 'New Conquests'.^[287] As the 'Old Conquests' has a stronger Portuguese influence than the 'New Conquests', it may be likely that the (earthen) architecture too bears more Portuguese (or European) resemblance.^{[288][289][290][291]}

In 'Region B', Sanguem, even today, it is possible to find owners who build their own houses with help from neighbours. Masons also exist in the region. In Neturlim village, the owners referred to their house as '*taip*', which analyses it was found to be a cob construction. The owner-builders in Salgini village related that earlier, houses used to be 'hand-moulded', indicating cob building. Today, they have adopted the rammed-earth technique.

Salgini is a forest community in the Western Ghats, a UNESCO classified (Natural) World Heritage Site.

In 'Region C', Pernem, the construction technique of the only earth house surveyed could not be identified. The

Earth construction techniques found in Alentejo:

- **Rammed-earth** (referred to as '*taipa*' in Portuguese).
(All 12 case-studies: 'Region A' — Survey nos. 1[1], 2[38]; 'Region B' — 3[9], 4[10], 5[11]; 'Region C' — 6[14], 7[39], 8[40]; 'Region D' — 9[18], 10[19]; 'Region E' — 11[25], 12[27]).
- **Adobe-bricks** ('*tijolo cru*').
(Three case-studies: 'Region A' — Survey no. 1[1] (internal walls); 'Region C' — Survey nos. 7[39] (between rammed-earth 'lifts', 8[40] (gables)).

Most inhabitants across the regions surveyed in Alentejo, described the rammed-earth construction method. Some mentioned adobe-bricks.

Three masons were interviewed: Joaquim Antonio Baptista (80 years when met in 2018), Manuel Lorenzo (63 years in 2018), and António Martins Inácio (about 70 years in 2018). Joaquim and Manuel were from Mourão ('Region C'), and António live in Vale Mortos, Serpa ('Region E'). Joaquim and António mainly described the rammed-earth technique. However, Manuel said that when he started working with earth buildings in 1970, he worked with adobe-bricks.

Alentejo is characterised by its rammed-earth constructions. This survey mainly concentrated on the Eastern part of Alentejo i.e. in the districts of Évora ('Region A', 'Region B', 'Region C') and Beja ('Region D', 'Region E') because of the concentration of rammed-earth constructions there.

²⁸⁷ Khedekar, *Goa: Land, Life and Legacy*, p.4

²⁸⁸ Borges and Feldmann, eds., *Goa and Portugal: Their Cultural Links*, p.41-47

²⁸⁹ Rangel-Ribeiro, ed., *Goa Aparanta – Land Beyond the End*, p.200-201

²⁹⁰ Pandit, *Hidden Hands: Master Builders of Goa*, p.100

²⁹¹ Silveira, *Lived Heritage, Shared Space: The Courtyard House of Goa*, p.72

owners however, referred to their house as 'taip' (it could be a cob construction, as in the case of 'Region B' (Neturlim)). Two masons were spoken to in the region. Babu Shabi Gadakar (67 years old when interviewed in 2018), and Babuso A. Mandrekar (67 years old in 2018). Babu explained the cob technique. Whereas, Babuso described rammed-earth, and adobe-bricks.

Goa's best known masons are known to hail from Pernem. Often, there used to be at least one mason residing in each household.

C. WALLS AND TYPOLOGY

- The rammed-earth buildings analysed in Goa displayed walls that had a smooth and uniform finish. The 'lifts' were not visible (a layer of earth in earthen constructions is referred to as a 'lift'; in this context, if layers exist within a 'lift' they are often simply called 'layers'). The thickness of the external walls ranged from 32-40cm.

The holes left by the rammed-earth form-work were filled-up, and the walls were beaten with a wooded bat during construction. This was done to achieve better compaction and a neat surface. In Salgini, it was told that laterite-stones were randomly used in the construction of the walls; however, these are not visible on the wall surfaces.

**The act of beating rammed-earth walls during construction might have been borrowed from the traditional cob method of the region.*

Masons explained that rammed-earth walls display a neat finish but are of an inferior quality for Goa's climatic conditions. On receiving heavy rainfall, the earth tend to break loose from the rammed-earth walls.

- In Goa, adobe-bricks were found to constitute whole walls, gable walls, and were used in foundations. The sizes of the bricks varied from building to building. In one case, different adobe-brick dimensions were recorded even though the bricks existed on the same wall: 24x14cm, 30x14cm, 34x14cm (Survey no. 4). In another building, the adobe-bricks measured 43x19cm (Survey no. 10).

- In the rammed-earth buildings studied in Alentejo, the lengths of the rammed-earth blocks varied from 1.50-2.50m, and the height from 45-55cm. The external wall thickness measured 40-57cm.

Alentejo is witness to a wide variety of rammed-earth typologies. The rammed-earth blocks comprise one or two layers. Some buildings display a simple typology i.e. with no reinforcement materials between 'lifts' and/or layers. Others have mortar, mortar + fired-brick, mortar + fired-brick + mortar, mortar + schist + mortar, schist, adobe-bricks, etc.

- In certain regions of Alentejo, adobe-bricks were used to construct internal walls, gables, and in horizontal courses. External walls built with adobe-bricks also exist in Alentejo. The dimension of the bricks varied: 30x20x10cm (Survey no. 1[1]), 30x17x8cm (Survey no. 7[39]), and 33x16x10cm (Survey no. 8[40]).

D. CONSTRUCTION DETAILS

In both, Goa and Alentejo, materials available locally were used in building. Construction details too were adapted to suit their respective environments. Below are a few examples.

- Base-courses and corners were built in earth, or laterite-stone + earth.

Buildings that had an earth base-course tended to have corners in earth too, and likewise in case of laterite-stones.

- Base-course were constructed in stone and/or fired-bricks. Corners were in earth, stone and/or fired-bricks.

- No buttresses and/or tie-rods were recorded in any of the buildings surveyed in Goa. Buttresses are usually seen in bigger buildings, such as churches.
- **Holes left by the rammed-earth form-work covered with earth.**



Holes left by the rammed-earth form-work covered with earth.

- All the structures in Goa had large overhangs that extended from the main roof. In addition, temporary overhangs were mounted along wall facades and/or above window openings, just before the torrential monsoon season every year. The roof overhangs were usually covered with roof-tiles. The temporary overhangs were traditionally made with coconut palm-leaves, though some have now covered them with tarpaulin or replaced them with metal sheets.



Overhangs, houses of Goa.

- Buttresses and/or tie-rods existed in some of the buildings analysed in Alentejo. These were particularly observed in buildings that did not have horizontal reinforcements between the rammed-earth 'lifts' and/or layers, and in regions susceptible to earthquakes.
- Walls built with soils comprising fine soil particles usually had the **holes left by the rammed-earth form-work covered with mortars** (Survey nos. 9[18], 10[19]).



Holes left by the rammed-earth form-work covered with mortars.

[Source: Correia, *Le pise d'Alentejo, Portugal*, 2000]

- Some buildings had overhangs made with fired-bricks or schist. They were sufficient to protect the walls from the moderate rainfall that the region receives.



Overhangs, houses in Portugal.

[Source: Correia, *Le pise d'Alentejo, Portugal*, 2000]

E. MORTARS

In earth walls, mortars were present in those parts that were built in laterite-stone masonry (base-courses, window frames, corners, etc.), and in adobe-brick walls. Mortars were observed in all the surveyed structures, except in the rammed-earth structures ('Region B', Salgini), where no laterite-stone or adobe-brick masonry were visible on wall surfaces.

Mortars were observed in rammed-earth and/or adobe-brick walls in:

- Horizontal and vertical joints of rammed-earth 'lifts' and/or layers.
- Between the rammed-earth wall, and wooden rafters or overhangs.
- To fill-up holes left by rammed-earth form-works.
- In adobe-brick masonry.

F. PLASTERS, RENDERS, PIGMENTS AND/OR PAINTS

- Usually, the external walls of the houses in Goa used to be plastered, rendered, and/or painted; there was a tendency to leave the rear wall exposed (today, this is no longer the case as most walls are found to

- **Principal facades were usually plastered, rendered, and/or painted.**

be plastered). **If not most or all external walls, at least the principal facades were plastered, rendered and/or painted.**

- **On the interiors, service rooms such as kitchens and storerooms sometimes received an inferior quality surface treatment, such as a single coat of lime only — or no plasters, pigments and/or paints at all.**

External and internal walls of secondary buildings such as distilleries, cowshed, etc. tended to have no plasters, renders, pigments and/or paint.

- **Some houses had a darker shade of pigments or paints along columns, motifs, wall-bases, and borders of doors and/or windows, especially on front facades.** This was sometimes observed on internal walls as well.
- **White, ochre, red, and blue pigments / paints were common.**

- **Exterior and interior walls of secondary buildings such as agricultural annexes and animal sheds received a lesser quality treatment, such as an earth or lime wash — or no plasters, renders, pigments and/or paints at all.**

- **Walls were usually painted white. Wall-bases, and doors and/or window frames were sometimes highlighted in colour.**

- **White, ochre, red, grey and blue pigments / paints were commonly used.**

G. MATERIALS USED IN MORTARS, PLASTERS, RENDERS, PIGMENTS AND/OR PAINTS

- **Earth and/or lime mortars** were used. Sometimes, earth mortars were re-pointed in lime.

- **Plasters** were mainly in **lime**.

- Lime was traditionally produced by treating sea-shells (called '*chuno*' in Konkani).

- As for the pigments, ochre and red were found naturally; they were derived from different varieties of laterite. **Blue was got from indigo, which was transported from India to Portugal via the ports in Goa.**^[292]

- **Cement was observed in mortars and plasters in some cases. It was obviously a latter addition.**

- **Mortars were in earth and/or lime.**

- Earth or **lime plasters** were found.

- Limestone was burnt in kilns to make lime. Two varieties of lime were found: White-lime ('*cal branca*' in Portuguese), and black-lime (referred to as '*cal preta*', '*cal parda*', '*cal de obra*' or '*cal morena*').

- Ochre and red were pigments found naturally in soil. Grey was gathered from the ashes and soot in chimneys. **Blue was commercially available in powder form.**

- **Cement plasters existed in some cases. These were recent additions.**

H. TERMINOLOGY

Some words in the Konkani (especially the dialect used in the 'New Conquests') seem to have been derived from the Portuguese language.

- **Interestingly, rammed-earth buildings are referred to 'taip' in Konkani.**

- Adobe-brick is called 'box', which is obviously derived from English. One mason, Bernardo ('Region A') referred to adobe-brick or its mould as 'caix' ('*caixa*' means 'box' in Portuguese).

**Cob houses are called 'mathe ghor' in Konkani. It literally translates to 'house built with earth'.*

- **Rammed-earth is called 'taipa' in Portuguese.**

- Adobe-brick is known as 'tijolo cru' in Portuguese.

²⁹² Nadri, *The Political Economy of Indigo in India, 1580-1930: A Global Perspective*. p.86,97

Most other vocabulary related to rammed-earth have different appellations in Konkani and Portuguese.

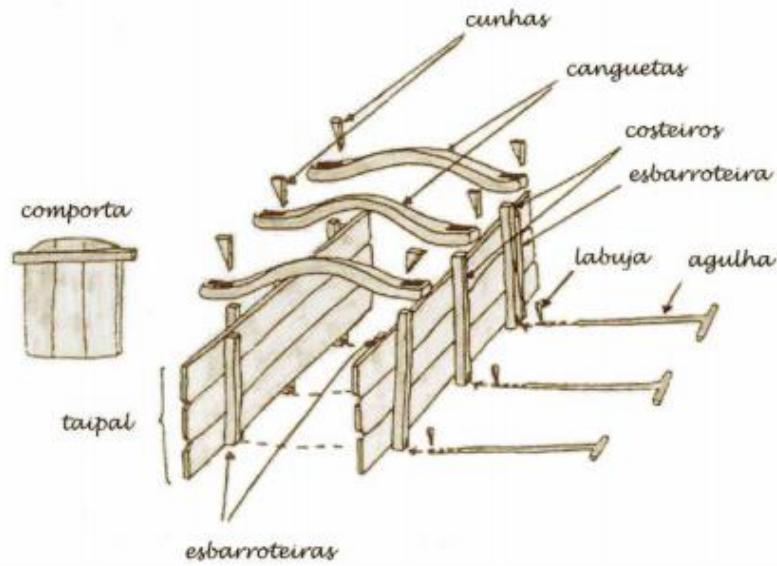

Parts of the rammed-earth frame-work. [Source: Parreira, *Análise Sísmica de uma Construção em Taipal*, p.7]

English	Konkani	Portuguese
Forms, shutters	Taipp ^[293]	Taipas, taipal
End-stops	Phodé, holé	Comportas
Wedges	Vanyo (?), kovyo (?), kutti ^[294]	Cunhas
Bolts		Cadeias / Canguetas
Ribs	Vanshe ^[295]	Costeiros
Wedges or pins		Labuja
Bolts	Arão, kiddi, ^[296] chavi ^[297]	Agulhas
Spacers	Kani	Côvados
Ramming-tool, rammer	Musal	Maços
Batten	Patnem ^[298]	
Vertical members that comprise the shutter		Esbarroteira
Horizontal members that comprise the shutter	Fadim ^[299]	
Wooden bat	Pattnem ^[300] (used only in Goa)	

Other vocabulary related to earthen constructions:

<ul style="list-style-type: none"> ◦ 'Lift' ◦ Layer (A layer of earth in earthen constructions is referred to as a 'lift'; in this context, layers within the 'lift' are simply called 'layers') ◦ The first, below most 'lift' (cob constructions) 	<ul style="list-style-type: none"> ◦ Parro (singular), paré (plural)^[301] ◦ Teno, tor, intuj 	<ul style="list-style-type: none"> ◦ Fio de taipal ◦ Camada
Lime (used in building)	Chuno	Cal

²⁹³ Lobo, *Earth in Architecture*, p.44

²⁹⁴ Ibid.

²⁹⁵ Ibid., p.45

²⁹⁶ Ibid., p.44

²⁹⁷ Ibid.

²⁹⁸ Ibid., p.50

²⁹⁹ Ibid., p.45

³⁰⁰ Lobo, *Earth in Architecture*, p.44

³⁰¹ Ibid.

Other Konkani words related to construction and architecture that may have been influenced by Portuguese include:		
Balcony / veranda	Sopo (singular), sope (plural), balkâmv , ^[302]	Balcão , ^[303] varanda
Chapel	Copel	Capela
Church	Igoj, firgoz	Igreja (church), freguesia ^[304] (parish)
Concrete	Beto	Betão
Foundation of house	Gharachi bunyad, betto ('betão' means 'concrete' in Portuguese)	Fundação
Hall	Chowk, sal, saletas ^[305] (small halls)	Sala de entrada, saletas (small halls)
Hammer	Hatodi, mortel	Martelo
Hole	Burak	Buraco
Ladder	Nosan, escade	Escada
Mason, stonemason, bricklayer	Govno, pedrel, pedreiro ^[306]	Pedreira (singular), alvanéus (old word, used till about 19th Century)
◦ Master-craftsman (referred to both, masons and Carpenters) ^[307]	◦ Karagir, mestre , ^[308] fishaal, ^[309] meste , ^[310] maestre , ^[311] mistri , ^[312] gavandi ^[313]	◦ Mestre
◦ Carpenters	◦ Mest , sutars, ^[314] thovoi (South Goa), ^[315] chari (North Goa) ^[316]	◦ Carpinteiros
Oven	Forn	Forno
Particles	Kuskut, particule	Partículas
Pickaxe	Pikander , ^[317] pikandar , pikao , ^[318] pikas	Picareta
Trowel	Thapi, ^[319] culher	Colher
Wood	Lakud, moder	Madeira
Wooden door or window frame	Lakdache dar, casil	Caixilho
	Monte (chapel on the top of a hill)	Monte (house on the top of a hill) ^[320]
	Tizule (floor-tiles)	Tijolo cru (adobe-brick), tijolo cozido (fired-brick)

I. DATE OF CONSTRUCTION

It would be worth analysing the age of the buildings surveyed in Goa and Alentejo to see if one earth construction technique proceeded another, within each of the regions. The hypothesis is that if any construction technique in Goa or Alentejo is found to have been introduced at a later date, it could indicate that it was influenced by the region in which it existed prior to this.

◦ Six (out of 13 cob buildings) surveyed in Goa were more than 100 years old ('Region A' — Survey nos. 2, 4, 5, 7, 8; 'Region B', Neturlim — Survey no. 15). Others were built about 50-80 years ago ('Region A' Survey nos. 3 (in 1940s), 6 (1965), 9 (1949-50), 10

◦ Six (out of 12 rammed-earth buildings) surveyed in Alentejo were over 100 years old ('Region B' — 3[9], 4[10], 5[11]; 'Region C' — Survey nos. 6[14], 7[39], included horizontal courses in adobe-brick; 'Region E' — Survey no. 11[25]). Three were about 70-100

³⁰² Silveira, *Lived Heritage, Shared Space: The Courtyard House of Goa*, p.104

³⁰³ Ibid., p.104

³⁰⁴ Correia, *Rammed Earth in Alentejo*, p.21

³⁰⁵ Pandit, *Hidden Hands: Master Builders of Goa*, p.97

³⁰⁶ Ibid., p.89

³⁰⁷ Ibid., p.88

³⁰⁸ Ibid., p.88, 94

³⁰⁹ Ibid., p.88

³¹⁰ Ibid., p.111

³¹¹ Ibid., p.89

³¹² Ibid., p.94

³¹³ Ibid., p.105

³¹⁴ Ibid., p.87

³¹⁵ Ibid., p.88

³¹⁶ Ibid.

³¹⁷ Ibid., p.93

³¹⁸ Ibid., p.106

³¹⁹ Ibid.

³²⁰ Correia, *Rammed Earth in Alentejo*, p.22

(1970, include adobe-brick gables), 11 (1967); 'Region C' — Survey no. 14 (1952)).

The adobe-brick gable ('Region A' — Survey no. 4), and rammed-earth buildings were constructed more recently, and are less than 30 years old ('Region B', Salgini — Survey nos. 12 (in about 1988), 13 (completed in 2014)).

As another study quotes, "In Goa, the rammed-earth technique is much more recent as compared to the other wall construction techniques. As surveyed, most houses built in rammed-earth were about 75-85 years old, while very few were about 100 years of age." (Lobo, *Earth in Architecture*, 2006, p.41).

**"Cob construction is a wall construction technique which is the most popular and has been in almost all parts of Goa." (Lobo, Earth in Architecture, 2006, p.47).*

years in age ('Region A' — Survey nos. 1[1] (in 1920, include adobe-brick internal walls), 2[38] (1927); 'Region C' — Survey nos. 8[40] (+/- 1950), include adobe-bricks gables). One rammed-earth building was built less than 25 years ago ('Region E' — Survey no. 12[27]).

J. RAMMED-EARTH FORM-WORK AND TOOLS

Photos of traditional and recent rammed-earth form-works, and tools were gathered during the research. The form-works in both, Goa and Portugal continue to evolved with time.



[Source: Soeiro de Brito, *Goa e as Praças do Norte*, 1966, p.50]

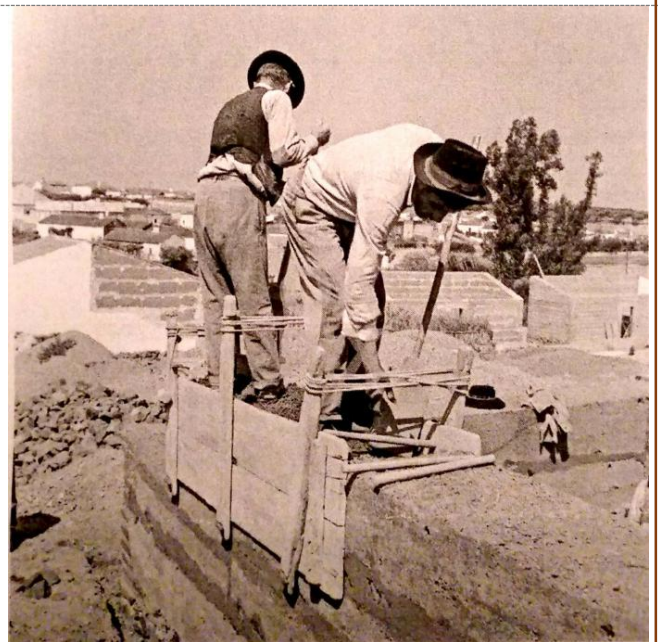

[Source: Shared by Mason-Sailor, Joaquim Antonio Baptista]



Traditional rammed-earth form-work of Alentejo

[Source: Associação Centro da Terra. *Arquitetura de Terra em Portugal. Earth Architecture in Portugal*, 2005, p.23]



Form-work with ribs and spacers ('kani' in Konkani)
 [Source: Lobo, *Earth in Architecture*, 2006, p.42]



Traditional rammed-earth form-work used Aldeia da Luz in Évora before the 1950's.
 [Source: Panel at Museu da Luz, Luz, Évora, 2018]

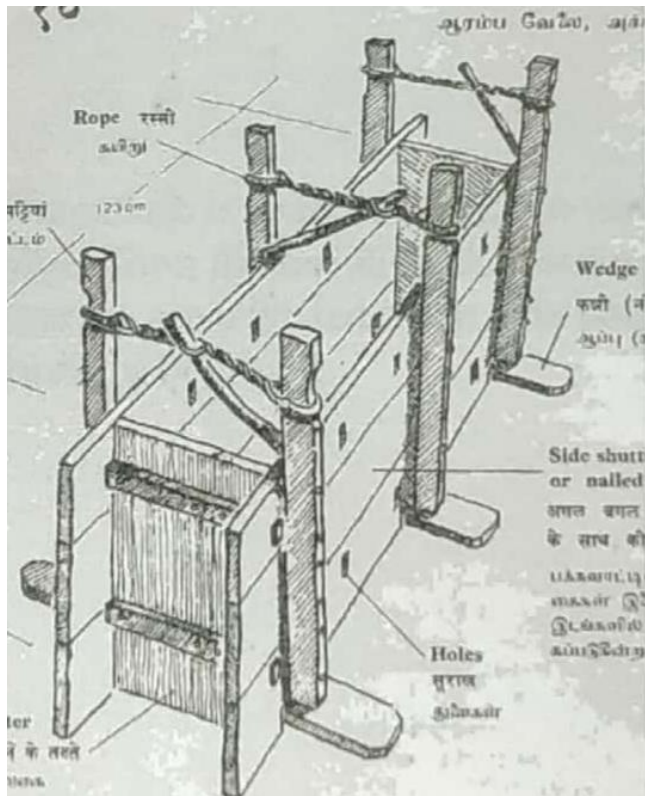

[Source: Lobo, *Earth in Architecture*, 2006]



[Source: Parreira, *Análise Sísmica de uma Construção em Taipa*, 2007]

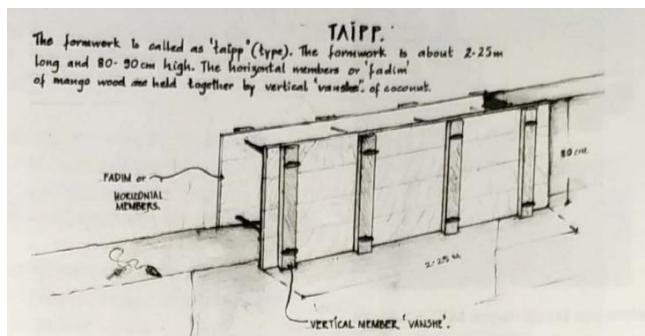

Form-work with bolts ('arão', 'kitti', or 'chavi' in Konkani) and spacers [Source: Lobo, *Earth in Architecture*, p.45]



Model made by a local mason
 [Source: Shared by Catarina Pereira (Architect, Portugal), 2018]



Form-work with bolts and spacers, and tools
 [Source: Lobo, *Earth in Architecture*, p.44]



[Location: Museu da Luz, 2018]

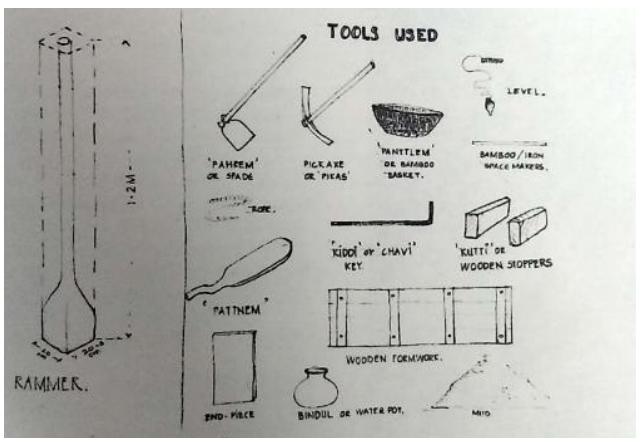

Parts of the form-work with bolts and spacers, and tools
 [Source: Lobo, *Earth in Architecture*, p.44]

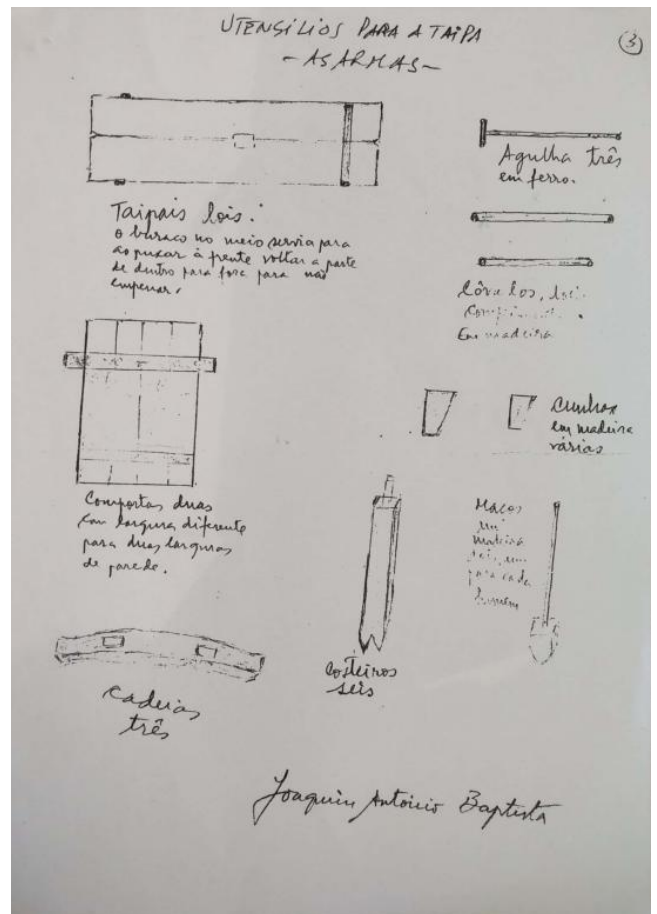

[Drawings by Mason-Sailor, Joaquim]

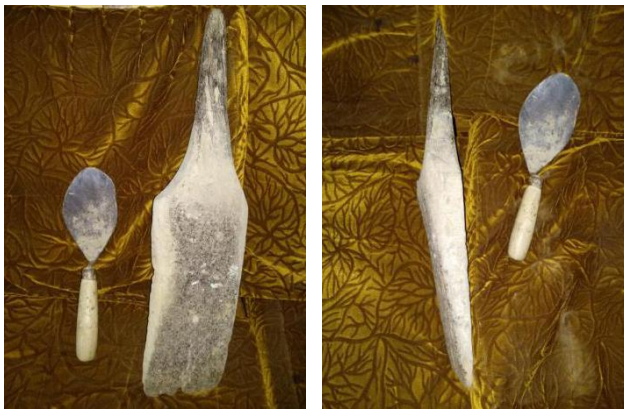

Trowel and 'pattnem' that belonged to Mason Bernardo Sequeira.



'Pattnem' used by the owner-builders in Salgini village to build their rammed-earth houses.



Mason-Sailor, Joaquim's tools.

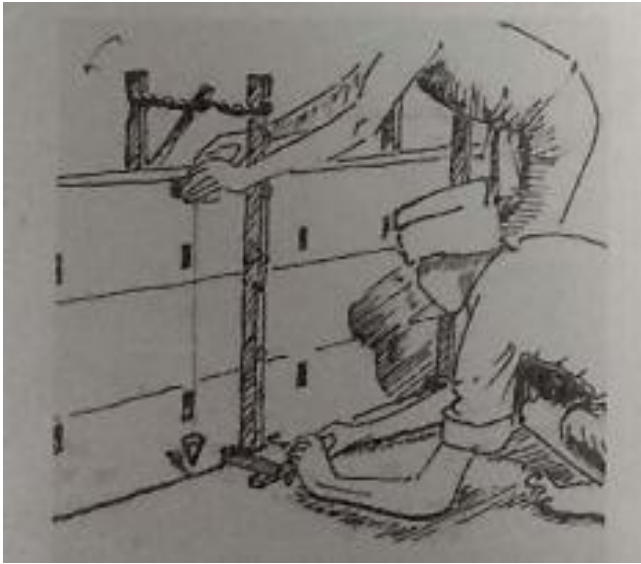

Checking levels with the plumb.
 [Source: Lobo, *Earth in Architecture*, p.43]

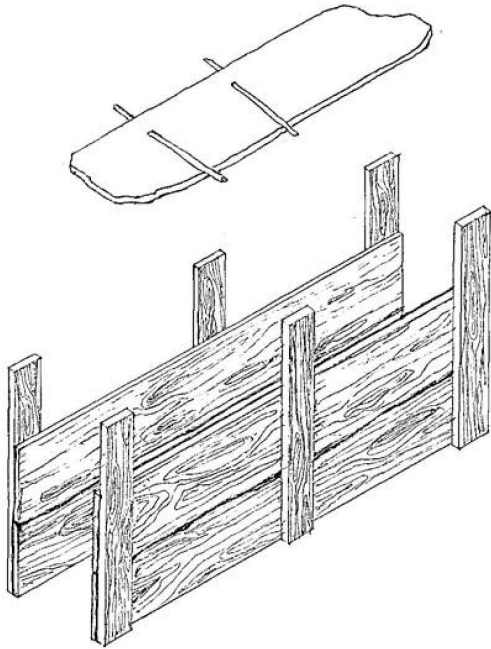

Parts of a recent rammed-earth form-work used in Goa (4 images).
 [Drawing by Lionel Afonso]



Mason-Sailor Joaquim showing his 100 years old plum tool used in rammed-earth constructions.



Sample of recent rammed-earth form-work in Portugal (2 images)
 [Source: BION. Building Impact Zero Network.
 Location: Galeria Municipal, Montemor-o-Novo, Évora, 2018]



Recent rammed-earth form-works used in Goa.



Recent rammed-earth form-works in Goa.



Modern rammed-earth form-work in Portugal.

[Source: Facebook, João Bernardino, Lda. Construções Ecológicas, June 8, 2018 (accessed January 18, 2020)]

Some details on the rammed-earth form-works used in Goa:

- Initially, rammed-earth form-works in Goa was made with wood from the mango tree.^[321]
- **In early rammed-earth form-works in Goa, ropes were used to secure the ribs.**
- Several wooden planks form a single shutter (the wooden planks are called '*fadim*', and shutters are called '*taipp*' in Konkani).
- A wooden bat ('*pattnem*' in Konkani) is used to compact rammed-earth walls during construction.

Details of rammed-earth form-works used in Portugal:

- Form-works were made from pine wood.^[322]
- **In early rammed-earth form-works in Portugal, ropes fasten the ribs ('*costeiros*' in Portuguese).**
- Two wooden planks form each shutter (shutters are called '*taipas*' or '*taipal*' in Portuguese).

³²¹ Lobo, *Earth in Architecture*, p.42

³²² Pereira, *Savoir-faire, Enseignement et Construction en Pisé Dans Le Bas Alentejo*, p.38

9.2. CONSERVATION APPROACHES

A. DAMAGES INCURRED, PROBLEMS, AND CHALLENGES FACED

- | | |
|---|---|
| <ul style="list-style-type: none"> ◦ Building in ruins. ◦ Roof: Cracking of roof-tiles (especially during monsoons as animals walk on damp tiles) leads to water leakage and damage to rafters, rotting of roof framework due to termite attack. ◦ Walls: Bulge in walls, cracks, dampness in walls, disintegration of wall parts, chipping (especially corners) and holes in walls (sometimes made by birds, rats, etc.), bee holes, erosion of wall bases, water run-off eroding walls, insects build earthen-nests on interior walls, darkening of kitchen walls because of some from wood-burning-stoves, flaking and falling plasters. ◦ Floors: Chipped floors, holes in flooring, dampness of floors during monsoons. | <ul style="list-style-type: none"> ◦ Buildings in ruins. ◦ Roof lost in fire, winds cause roof to destabilise and dislocate roof-tiles, cracking of roof tiles if animals walk on them during monsoons, rotting of roof framework. ◦ Walls: Parts of walls have broken down, cracks, holes, bee holes, degraded mortars, warping and falling plasters, graffiti. ◦ Floors: Floor-tiles have been chipped-off. |
|---|---|

B. MAINTENANCE AND REPAIRS

- | | |
|---|--|
| <ul style="list-style-type: none"> ◦ Roof: Regular roof maintenance required. ◦ Walls: Temporary rainwater barriers installed before monsoon, cracks repaired, disintegrated parts of walls are filled-up, annual repainting of walls before festivals. ◦ Floors: Regular re-layering of cow-dung and red-oxide floors. | <ul style="list-style-type: none"> ◦ Roof: Regular roof maintenance required. ◦ Walls: Cracks repaired, buttresses and/or tie-rods added to stabilise walls, annual whitewashing of walls before the village feast. |
|---|--|

C. FUTURE PLANS

Most, if not all owners intend to demolish their earth houses and reconstruct them in laterite-and-cement masonry. It is a general notion that the latter material is stronger and better.

Some owners have stalled repairs and reconstruction of their house either because property division among heirs is still pending, or they are awaiting ownership status. (As per the Goa Mundkar Protection from Eviction Act 1975, tenants are entitled to their plot of land if they have been living there for generations, and they fulfil certain criteria.)^[323]

Some owners communicated that they would continue using their buildings like they are. Only one said that he would like to reconstruct his house in fired-bricks as he does not trust rammed-earth constructions.

³²³ Merchant, "Tenant cannot become mundkar: HC," *The Times of India*, November 27, 2012

10. CONCLUSION

Two earth construction techniques were found to be common in Goa and Portugal: Rammed-earth and adobe-bricks.

Two (out of 16) buildings surveyed in Goa were in rammed-earth, and two had adobe-bricks. The rest were in cob. In one case, the **construction technique** could not be identified. All 12 structures studied in Alentejo were in rammed-earth. Three of them included adobe-bricks as well.

Interestingly, the **terminology** used to refer to rammed-earth buildings was similar in Goa and Portugal. Rammed-earth is referred to as 'taip' in Goa, and 'taipa' in Portugal. In Goa, adobe-bricks are called 'box' (derived from English), though one mason referred to the adobe-brick or the adobe-brick mould as 'caix' ('caixa' means 'box' in Portuguese). In Portugal, adobe-bricks are called 'tijolo cru'.

The **construction dates** of the structures in both regions were analysed. The rammed-earth constructions surveyed in Goa for this study were less than 30 years old. However, another study mentions that rammed-earth is a recent technique in Goa with most houses being 75-85 years old; only a few are about a 100 years (Lobo, *Earth in Architecture*, 2006). The adobe-brick constructions surveyed in Goa were relatively recent as well — as compared to the cob constructions, which were the oldest with many buildings dating to more than 100 years old. In Alentejo, the rammed-earth and adobe-brick buildings date to more than 100 years old.

Photos show that **rammed-earth form-works** in Goa and Portugal have evolved with time. A striking similarity observed in the early form-works used in both regions was the use of ropes to secure the 'ribs' (vertical members of shutters).

The lack of clarity in the terminology used to refer to adobe-bricks, and the ambiguity in dating the period when adobe-brick constructions started in Goa, make it hard to infer whether the adobe-brick technique in Goa has a Portuguese influence. However, **the rammed-earth buildings in Goa and Portugal have similar appellations ('taip' in Goa, and 'taipa' in Portugal). In addition, rammed-earth buildings in Goa are relatively new (compared to cob). They began to be constructed in the early 20th Century i.e. a few decades before the Portuguese quit Goa in 1961 (Lobo, *Earth in Architecture*, 2006). These could be indications that rammed-earth was introduced in Goa by the Portuguese.** Further research could shed more light on the same.

The fact that Goa's traditional builders reiterate that the soils from rammed-earth walls tend to break loose owing to heavy rainfall, suggests that rammed-earth buildings are not resilient to Goa's climatic conditions. The owner-builders in the forest community of Salgini village also mentioned that before houses used to be 'hand-moulded' (indicating cob constructions), but today the rammed-earth technique is employed. These could yet again suggest that the rammed-earth technique is not indigenous to Goa.

On the other hand, it was observed that the indigenous cob constructions, and its Konkani appellation, 'mathe ghor' (which simply translates to 'house built with earth') was popularly used in the 'Old Conquests' (regions in Goa seized by the Portuguese from 1510-1543). However, rammed-earth constructions, and the use of the term 'taip' were witnessed in the 'New Conquests' (regions captured from 1763-1788). In the 'New Conquests', the term 'taip' was sometimes used to refer to a 'mud house', and not precisely a rammed-earth house. It is interesting how the 'Old Conquests', which has a stronger Portuguese cultural and architectural influence,^{[324][325][326][327]} still retains the indigenous earth construction technique and vocabulary, and the 'New Conquests' has adopted those that are likely to have been influenced by the Portuguese.

In addition to terminologies, construction dates, and rammed-earth form-works used, similarities were also observed in various 'construction details', 'plasters, renders, pigments and/or paints', and 'conservation approaches'. However, these are likely to be standard similarities observed in earth constructions in general, or a response to local materials and the micro-environments Goa and Alentejo are respectively subjected to — and not necessarily an influence of one region over the other. However, **the use of blue colour on the walls of the houses of Goa and Portugal could be a common characteristic because indigo, from which the blue pigment was obtained was transported from India to Portugal via the port in Goa, and thus available in both regions.**^[328]

Today, there is a revival of earth constitutions in both, Goa and Portugal. Rammed-earth is currently popular in Goa. In Portugal, rammed-earth, adobe-bricks and compressed earth blocks are known.

³²⁴ Borges and Feldmann, eds., *Goa and Portugal: Their Cultural Links*, p.41-47

³²⁵ Rangel-Ribeiro, ed., *Goa Aparanta – Land Beyond the End*, p.200-201

³²⁶ Pandit, *Hidden Hands: Master Builders of Goa*, p.100

³²⁷ Silveira, *Lived Heritage, Shared Space: The Courtyard House of Goa*, p.72

³²⁸ Nadri, *The Political Economy of Indigo in India, 1580-1930: A Global Perspective*. p.86,97



ANNEXES — GOA

CLIMATE GRAPHS — GOA

[Source: Mahajan et al., *Weather trends of Last Fourteen Years (2002 – 2015)* at ICAR – Central Coastal Agricultural Research Institute, Old Goa]

TEMPERATURE

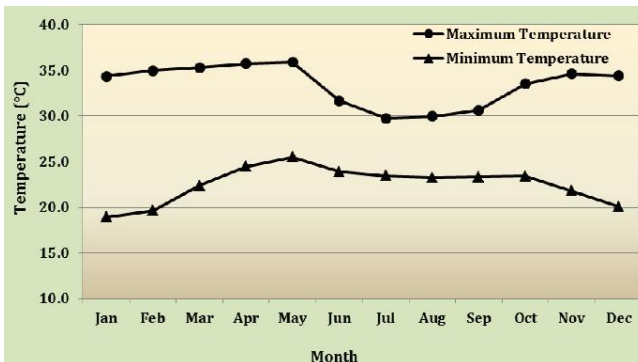
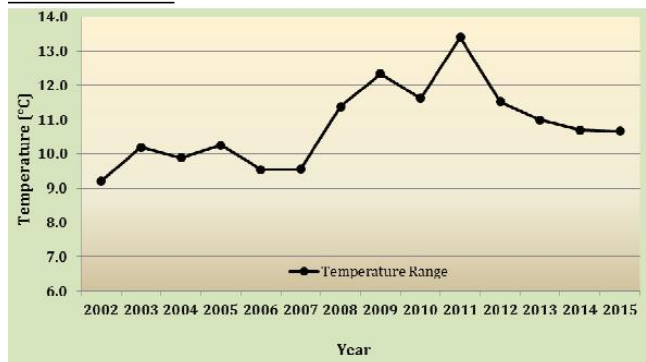

Figure 1: Mean monthly variation of average MaxT and MinT from 2002 to 2015.

Figure 2: Yearly variation of the difference between the MinT and MaxT during the period of 2002 to 2015.

RELATIVE HUMIDITY

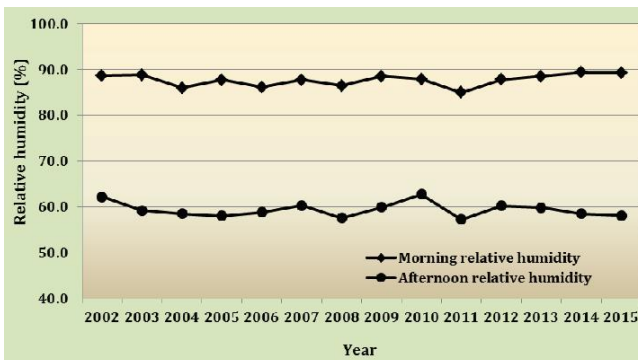
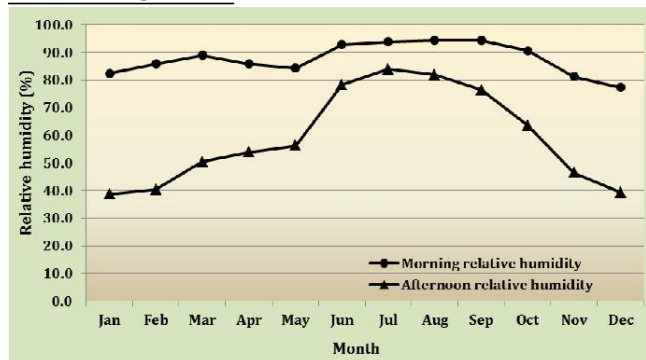

Figure 3: Mean monthly variation of average RH1 (morning) and RH2 (afternoon) from 2002 to 2015.

Figure 4: Yearly variation of average RH1 and RH2 from 2002 to 2015.

WIND SPEED

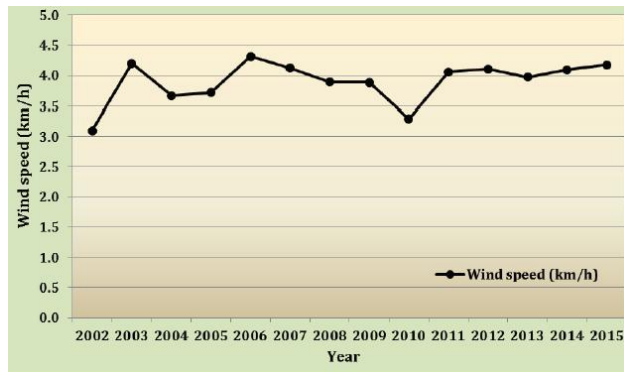

Figure 5: Mean monthly variation of average wind speed from 2002 to 2015.

Figure 6: Yearly variation of average wind speed during 2002 to 2015.

RAINFALL

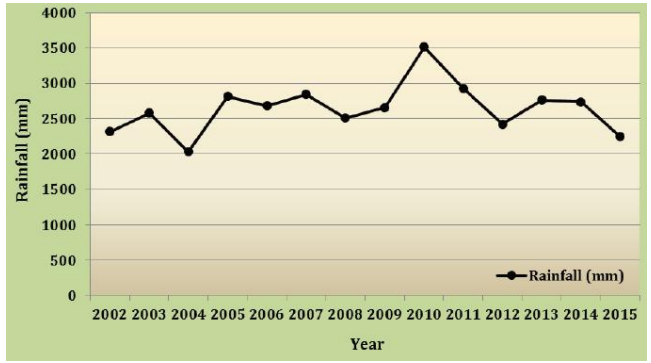
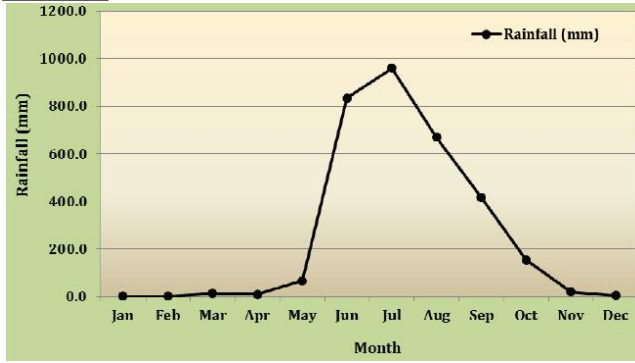

Figure 7: Mean monthly variation of rainfall (mm) from 2002 to 2015.

Figure 8: Yearly variation of average rainfall (mm) from 2002 to 2015.

SUNSHINE HOURS

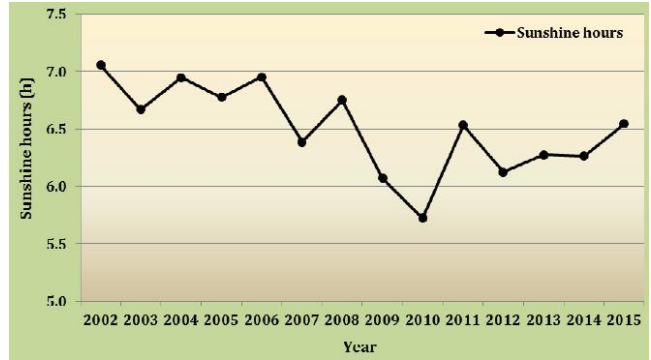

Figure 9: Mean monthly variation of average sunshine hours (h) from 2002 to 2015.

Figure 10: Yearly variation of average sunshine (h) during 2002 to 2015.

EVAPORATION

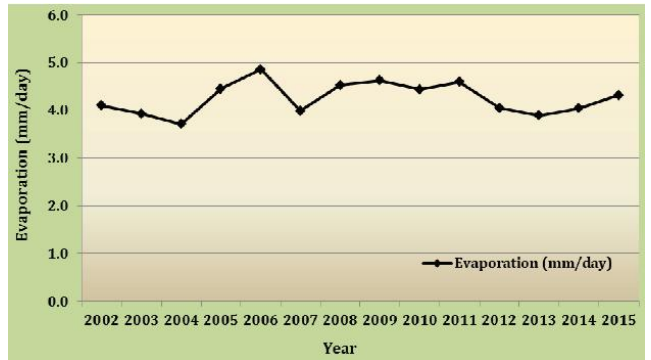
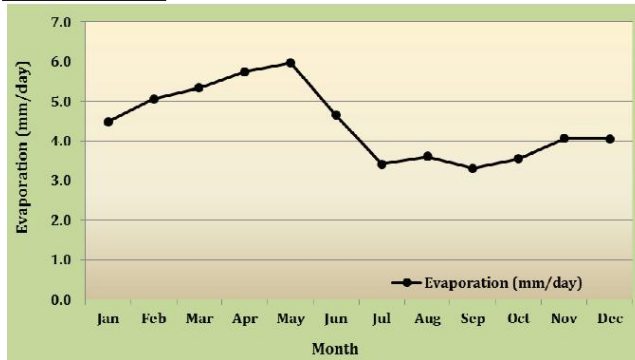

Figure 11: Month wise variation of average evaporation (mm) during 2002 to 2015.

Figure 12: Year wise variation of average evaporation (mm) from 2002 to 2015.

SOIL LEGEND – GOA^[329]

(The soil temperature regime is isohyperthermic)

KONKAN COAST

Soils of the Konkan Coast^[330]

The Konkan Coast comprises of level to nearly level fluvio-littoral marine landform and undulating to rolling dissected hilly landform.

The fluvio-littoral marine landform comprises beaches and beach ridges, mudflats, swamps and marshes, salt pans, fluvio-littoral plains and islands.

Dissected hilly landform consists of conical hills, flat-topped hills, hillside slopes, undulating lands, colluvial lowlands/narrow valleys. The different soil series occurring in Konkan Coast are Harmal, Mandavi, Kalangut, Kolva, Panaji, Zuvvari, Uguem, Padi, Madgaon, Nagowa, Raya, Dabolim, Karmali, Karven, Verna, Chapora, Zaimolo, Saligao, and Batim.

The fluvio-littoral landform is composed mainly of marine alluvium while the dissected hilly landform is mainly composed of laterites.

Map Symbol	Major soils	Inclusions	Area (%)
Fluvio-littoral marine landform			
<i>Beach and beach ridges</i>			
1	Harmal Very deep, somewhat excessively drained, light gray to brown, sand surface soil and light yellowish brown to very pale brown, sand subsoil; 1 to 3 per cent slope, moderately eroded. <i>Mixed, (calcareous), Typic Ustipsamment</i>		1078 (0.29)
<i>Mudflats</i>			
2	Mandavi Deep, poorly drained, grayish brown to very dark grayish brown, sand surface soil and very dark grey to dark grayish brown sand subsoil; 1 to 3 percent slope, slightly eroded, subjected to severe flooding in most years. <i>Mixed, (calcareous), Typic Psammaquents</i>		1027 (0.27)
	Kalangut Deep, imperfectly drained, very dark brown to dark gray, loamy sand surface soil and dark gray to yellowish brown, sandy clay loam to sandy loam subsoil with cambic horizon and distinct mottles of light brownish gray colours, 0 to 3 per cent slope, slightly eroded. <i>Fine-loamy, mixed, Typic Tropaquept</i>		
<i>Swamps and marshes</i>			
3	Kolva Deep, poorly drained, dark yellowish brown to very dark yellowish brown, sandy loam surface soil and dark gray to very dark grayish brown, clay loam to sandy clay loam subsoil with cambic horizon and prominent dark yellowish brown mottles, 0 to 1 percent slope, slightly eroded. <i>Fine-loamy, mixed, Typic Tropaquept</i>		558 (0.15)
<i>Salt pans</i>			
4	Panaji Moderately deep, imperfectly drained, light brownish gray to dark grayish brown, sandy loam surface soil and gray to very dark grayish brown sand sand subsoil with prominent strong brown to reddish brown mottles; 0 to 1 per cent slope, slightly eroded with surface salt		641 (0.17)

³²⁹ National Bureau of Soil Survey & Land Use Planning, *Soils of Goa for Optimising Land Use b. Executive Summary*, p.17-27

³³⁰ Ibid, p.28,33

	encrustation. <i>Mixed, Typic Tropopsammaquents</i>		
	Harmal See unit 1 <i>Mixed, (calcareous), Typic Ustipsamment</i>		
<i>Plains</i>			
5	Zuvari Deep, imperfectly drained, dark yellowish brown, clay surface soil and dark yellowish brown to very dark gray, clay subsoil with cambic horizon and distinct yellowish brown mottles; 0 to 3 per cent slope, slightly eroded with slight salinity in patches. <i>Very fine, mixed, Aquic Ustropept</i>	Uguem <i>Fine, mixed, Fluventic Ustropept</i>	21772 (5.88)
	Kalangut See unit 2 <i>Fine-loamy, mixed, Typic Tropaquept</i>		
6	Kalangut See unit 2 <i>Fine-loamy, mixed, Typic Tropaquept</i>	Zuvari <i>Fine, mixed, Aquic Ustropept</i>	3654 (0.99)
	Uguem Deep, imperfectly drained, dark brown to very dark grayish brown, clay surface soil and dark brown to very dark gray, clay subsoil with cambic horizon and distinct brown mottles, 0 to 3 per cent slope, slightly eroded. <i>Very fine, mixed, Fluventic Ustropept</i>		
<i>Dissected hilly laterite landform</i>			
<i>Islands</i>			
7	Padi Moderately deep, well drained, brown to dark yellow-ish brown, gravelly sandy loam surface soil and dark yellowish brown to dark brown, gravelly sandy clay loam to gravelly clay loam subsoil with cambic horizon and more than 35 per cent coarse gravels in surface and subsurface layers; 3 to 8 per cent slope, moderately eroded. <i>Loamy-skeletal, mixed, Ustoxic Dystropept</i>		105 (0.03)
	Madgaon Deep, well drained, reddish brown to dark reddish brown, gravelly loamy sand surface soil and yellowish red to red, gravelly sandy clay loam to gravelly clay sub-soil with cambic horizon and more than 35 per cent coarse gravels, 8 to 15 per cent slope, moderately eroded. <i>Loamy-skeletal, mixed, Fluventic Ustropept</i>		
<i>Conical hills</i>			
8	Nagowa Deep, well drained, reddish brown to dark reddish brown, gravelly sandy clay loam surface soil and dark brownish yellow to reddish brown gravelly clay to clay subsoil with cambic horizon; 8 to 15 per cent slope, moderately eroded. <i>Fine, mixed, Ustoxic Dystropept</i>	Madgaon <i>Loamy-skeletal, mixed, Fluventic Ustropept</i>	11698 (3.16)
	Padi See unit 7 <i>Loamy-skeletal, mixed, Ustoxic Dystropept</i>		
<i>Flat topped hills (Laterite mesas)</i>			
9	Raya Very shallow, well drained, strong brown to dark brown, gravelly clay surface soil with 40 per cent coarse gravels, 1 to 5 per cent slope, severely eroded. <i>Clayey-skeletal, mixed, Lithic Ustorthent</i> Laterite outcrop	Dabolim <i>Loamy, mixed Lithic Ustorthent</i>	6159 (1.67)

	(Hard indurated surface)		
10	Dabolim Very shallow, well drained, brown to very dark brown, sandy clay loam surface soil on hard laterite layer; 1 to 5 per cent slope, severely eroded. <i>Loamy, mixed, Lithic Ustorthent</i>	Laterite outcrops	10114 (2.73)
	Karmali Shallow, well drained, brown to dark brown, gravelly clay surface soil and strong brown to dark brown, gravelly clay subsoil with cambic horizon; 1 to 5 per cent slope, moderately eroded. <i>Clayey, mixed, Lithic Dystropept</i>		
<i>Hillside slopes (Escarpments)</i>			
11	Madgaon See unit 7 <i>Loamy-skeletal, mixed, Fluventic Ustropept</i>		40957 (11.07)
	Karven Deep, well drained, dark reddish brown, gravelly clay surface soil and reddish brown to red, gravelly clay subsoil with cambic horizon and more than 35 per cent coarse gravels in surface and subsurface layers; 8 to 15 per cent slope, moderately eroded. <i>Loamy-skeletal, kaolinitic, Oxic Ustropept</i>		
	Verna Shallow, well drained, reddish brown to dark reddish brown, gravelly sandy clay loam surface soil and red to dark red, gravelly clay subsoil with cambic horizon and more than 35 per cent coarse gravels in surface and subsurface layers; 8 to 15 per cent slope, moderately eroded. <i>Clayey-skeletal, mixed, Lithic Dystropept</i>		
<i>Undulating lands</i>			
12	Chapora Deep, well drained, brown to dark brown, sandy loam surface soil and yellowish brown to brown, sandy loam to sand clay loam subsoil with cambic horizon; 3 to 8 per cent slope, moderately eroded. <i>Fine-loamy, mixed, Typic Ustropept</i>	Zaimolo <i>Clayey, mixed, Typic Paleustult</i>	19901 (5.38)
	Nagowa See unit 8 <i>Fine, mixed, Ustoxic Dystropept</i>		
13	Zaimolo Deep, well drained, yellowish red to dark reddish brown, gravelly clay loam surface soil and red to dark red, gravelly clay subsoil with argillic horizon; and less than 5 per cent iron and manganese concretions; 3 to 8 per cent slope, moderately eroded. <i>Clayey, mixed, Typic Paleustult</i>	Nagowa <i>Fine, mixed, Ustoxic Dystropept</i>	8565 (2.31)
<i>Colluvial low lands/Narrow valleys</i>			
14	Zuvari See unit 5 <i>Very fine, mixed, Aquic Ustropept</i>	Kalangut <i>Fine-loamy, mixed, Typic Trophaquept</i>	8629 (2.33)
	Batim Deep, moderately well drained, yellowish brown to dark brown, sandy loam surface soil and yellowish brown to strong brown, clay loam to clay sub-soil with argillic horizon and less than 5 per cent iron and manganese concretions, 1 to 3 per cent slope, slightly eroded. <i>Fine, mixed, Kanhaplic Haplustalf</i>		
15	Batim	Zuvari	8537 (2.30)

	See unit 14 <i>Fine, mixed, Kanhaplic Haplustalf</i> Zaimolo See unit 13 <i>Clayey, mixed, Typic Paleustult</i>	<i>Very fine, mixed, Aquic Ustropept</i>	
CENTRAL SAHYADRI			
Soils of Central Sahyadri^[331]			
Central Sahyadri comprises rolling to hilly topography of granite and granite-gneiss landform, quartzite/schistose landform and basaltic landform.			
Granite/granite-gneiss landform in turn is composed of restricted summits and hillside slopes. Quartzite/schistose landform comprises restricted summits, high hills, low hills, interhilly basins and narrow valleys. Basaltic landform comprises restricted summits and high hills.			
The different soil series occurring in Central Sahyadri and Devabag, Dande, Gudi, Netravali, Torse, Velge, Gavane, Darbandora, Metavada, Bandoli, Arukot, Pali, and Surla.			
The brief description of the soil series is given in the section 4.3 based on the sequence as followed in soil legend. The detailed description along with the analytical data is given in the appendix following alphabetical order.			
Granite and granite-gneiss landform			
<i>Restricted summits</i>			
16	Devabag Shallow, somewhat excessively drained, dark yellowish brown, gravelly clay surface soil and dark brown to dark reddish brown, gravelly clay subsoil with cambic horizon and more than 35 per cent coarse gravels; 15 to 30 per cent slope, severely eroded. <i>Clayey-skeletal, mixed, Typic Ustropept</i>	Dande <i>Clayey, mixed, Kanhaplic Haplustult</i>	783 (0.21)
<i>Hillside slopes</i>			
17	Gudi Deep, well drained, light yellowish brown to dark yellowish brown, gravelly sandy loam to gravelly sandy clay loam surface soil and yellowish brown to strong brown, gravelly sandy clay loam subsoil with cambic horizon; 15 to 30 per cent slopes, severely eroded. <i>Fine-loamy, mixed, Ustoxic Dystropept</i>	Devabag <i>Clayey-skeletal, mixed, Typic Ustropept</i>	2121 (0.58)
	Dande Moderately deep, well drained, brown to dark brown, gravelly clay loam to gravelly clay surface soil and reddish brown to dark reddish brown, clay sub-soil with argillic horizon; 15 to 30 per cent slope, severely eroded. <i>Clayey, mixed, Kanhaplic Haplustult</i>		
Quartzite/schistose landform			
<i>Restricted summits</i>			
18	Netravli Slightly deep, well drained, dark reddish brown, gravelly clay surface soil and dark reddish brown, gravelly clay subsoil with cambic horizon and more than 35 per cent coarse gravels; 8 to 15 per cent slope, severely eroded. <i>Clayey-skeletal, mixed, Ustoxic Dystropept</i>	Velge <i>Loamy-skeletal, mixed, Lithic Ustorthent</i>	11394 (3.08)
	Torse Shallow, somewhat excessively drained, brown to dark brown, gravelly silty clay surface soil and dark brown, clay to gravelly silty clay surface soil and dark brown, clay to gravelly clay subsoil with cambic		
<hr/> <small>³³¹ National Bureau of Soil Survey & Land Use Planning, <i>Soils of Goa for Optimising Land Use b. Executive Summary</i>, p.33</small>			

	horizon, 15 to 30 per cent slope, severely eroded. <i>Clayey, mixed, Lithic Dystropept</i>		
<i>High hills</i>			
19	Torse See Unit 18 <i>Clayey, mixed, Lithic Dystropept</i>	Gavane <i>Clayey, mixed, Typic Dystropept</i>	97173 (26.25)
	Netravli See Unit 18 <i>Clayey-skeletal, mixed, Ustoxic Dystropept</i>		
20	Darbandora Moderately deep, somewhat excessively drained, brown to dark reddish brown, gravelly clay surface soil and dark reddish brown to dark red clay to gravelly clay subsoil with cambic horizon; 15 to 30 per cent slope, severely eroded. <i>Very fine, mixed, Ustoxic Humitropept</i>	Netravli <i>Clayey-skeletal, mixed, Ustoxic Dystropept</i>	10494 (2.83)
	Gavane Moderately deep, somewhat excessively drained, dark brown, gravelly clay surface soil and dark reddish brown, gravelly clay subsoil with cambic horizon and more than 35 per cent coarse gravels; 15 to 30 per cent slope, severely eroded. <i>Clayey-skeletal, mixed, Typic Ustropept</i>		
<i>Low hills</i>			
21	Metavada Shallow, somewhat excessively drained, dark reddish brown, gravelly clay surface soil and dark reddish brown, gravelly clay subsoil with cambic horizon and more than 35 per cent coarse gravels, 15 to 30 per cent slope, severely eroded. <i>Clayey-skeletal, mixed, Lithic Dystropept</i>	Netravli <i>Clayey-skeletal, mixed, Ustoxic Dystropept</i>	36819 (9.94)
	Velge Very shallow, somewhat excessively drained, brownish yellow to dark yellowish brown, gravelly sandy clay loam surface soil with more than 35 per cent coarse gravels and very dark grayish brown gravelly sandy clay loam subsoil 15 per cent slope, severely eroded. <i>Loamy-skeletal, mixed, Lithic Ustorthent</i>		
<i>Inter-hilly basin/valleys</i>			
22	Bandoli Deep, well drained, yellowish red, silty clay surface soil and dark yellowish brown to strong brown, clay subsoil with argillic horizon, and less than 5 per cent iron and manganese concretions; 3 to 8 per cent slope, moderately eroded. <i>Clayey, mixed, Typic Haplustult</i>		44073 (11.91)
	Arukot Deep, well drained, dark brown, clay surface soil and dark reddish brown to dark red, clay subsoil with an argillic horizon and less than 5 per cent iron and manganese nodules; 3 to 8 per cent slope, moderately eroded. <i>Very fine, mixed, Kandic Paleustalf</i>		
<i>Narrow valleys</i>			
23	Pali Moderately deep, moderately well drained, dark yellowish brown, loam surface soil and dark yellowish brown, loam surface soil and dark yellowish brown to yellowish brown, loam to clay loam subsoil with cambic horizon and prominent brown mottles, less than 8 per cent iron and manganese concretions; 1 to 3 per cent slope, slightly eroded. <i>Fine-loamy, mixed, Ustic Dystropept</i>		6996 (1.89)

	Bandoli See unit 22 <i>Clayey, mixed, Typic Haplustult</i>		
Basalt landform			
<i>Restricted summits</i>			
24	Rock outcrops (Boulders of basalt)		161 (0.04)
	Surla Moderately deep, well drained, brown to dark brown, clay surface soil and brown to dark brown, clay to gravelly clay subsoil with cambic horizon; 8 to 15 per cent slope, severely eroded. <i>Very fine, mixed, Typic Ustropept</i>		
<i>High hills</i>			
25	Surla See unit 24 <i>Very fine, mixed, Typic Ustropept</i>		1686 (0.46)
	Rock outcrops (Boulders of basalt)		

Brief description of the soil series^[332]

- Harmal:** Soils of Harmal series is a member of the Mixed, Typic Ustipsamments. These soils are very deep, somewhat excessively drained, light gray to brown, sand surface soil and light yellowish brown to very pale brown, sand subsoil; occurring on beach and beach ridges of fluvio-littoral landform; 1 to 3 per cent slope, moderately eroded.
- Mandavi:** Soils of Mandavi series is a member of the mixed, Typic Psammaquents. These soils are deep, poorly drained, grayish brown to very dark grayish brown, and surface soil and very dark gray to grayish brown and subsoil; occurring in mud flat region; 1 to 3 per cent slope, slightly eroded.
- Kalangut:** Soils of Kalangut series is a member of the Fine-loamy, mixed, Typic Tropaquepts. These soils are deep, imperfectly drained, very dark brown to dark gray, loamy sand surface soil and dark gray to yellowish brown, sandy clay loam to sandy loam subsoil with cambic horizon and distinct mottles of light brownish gray colours; occurring in the mudflat regions of Konkan coast; 0 to 3 per cent slope, slightly eroded.
- Kolva:** Soils of Kolva series is a member of the Fine-loamy, mixed, Typic Tropaquepts. These soils are deep, poorly drained, dark yellowish brown to very dark grayish brown, sandy clay loam surface soil and dark gray to very dark grayish brown clay loam to sandy clay loam subsoil with cambic horizon and prominent dark yellowish brown mottles; occurring in swamps and marshes; 0 to 1 per cent slope, slightly eroded.
- Panaji:** Soils of Panaji series is a member of mixed, Typic Psammaquents. These soils are slightly deep, imperfectly drained, light brownish gray to dark grayish brown, sandy loam surface soil and gray to very dark grayish brown, sand subsoil with prominent strong brown to reddish brown mottles; occur in salt pan regions; 0 to 1 per cent slope, slightly eroded, surface salt encrustations.
- Zuvari:** Soils of Zuvari series is a member of the Very fine, mixed, Aquic Ustropepts. These soils are deep, imperfectly drained, dark yellowish brown, clay surface soil and dark yellowish brown to very dark gray, clay subsoil with cambic horizon and distinct yellowish brown mottles; occurring on colluvial low lands and narrow valleys; 0 to 3 per cent slope, slightly eroded with slight salinity in patches.
- Uguem:** Soils of Uguem series is a member of the Very fine, mixed, Fluventic Ustropepts. These soils are deep, imperfectly drained, dark brown to very dark grayish brown, clay surface soil and dark brown to very dark gray clay subsoil with cambic horizon and distinct brown mottles; occur in plains; 0 to 3 per cent slope, slightly eroded.
- Padi:** Soils of Padi series is a member of the Loamy-skeletal, mixed, Ustoxic Dystropepts. These soils are slightly deep, well drained, brown to dark yellowish brown, gravelly sandy loam surface soil and dark yellowish brown to dark brown, gravelly sandy clay loam to gravelly clay loam subsoil with cambic horizon and more than 35 per cent coarse fragments in surface and subsurface horizons; occur in island regions; 3 to 8 per cent slope, moderately eroded.

³³² National Bureau of Soil Survey & Land Use Planning, *Soils of Goa for Optimising Land Use b. Executive Summary*, p.33-37

9. **Madgaon:** Soils of Madgaon series is a member of the Loamy-skeletal, mixed, Fluventic Ustropepts. These soils are deep, well drained, reddish brown to dark reddish brown, gravelly loamy sand surface soil and yellowish red to red, gravelly sandy loam to gravelly clay subsoil with cambic horizon and more than 35 per cent coarse gravels; occurring in island regions; 8 to 15 per cent slope, moderately eroded.

10. **Nagowa:** Soils of Nagowa series is a member of the Fine, mixed, Ustoxic Dystropepts. These soils are deep, well drained, reddish brown to dark reddish brown, gravelly sandy clay loam surface soil and brownish yellow to dark reddish brown gravelly clay to clay subsoil with cambic horizon; occur in dissected hilly landform (conical hills); 8 to 15 per cent slope, moderately eroded.

11. **Raya:** Soils of Raya series is a member of the Clayey-skeletal, mixed, Lithic Ustorthents. These soils are very shallow, well drained, strong brown to dark brown, gravelly clay surface soil with 40 per cent coarse fragments on hard laterite layer; occur on flat topped hills of laterites; 1 to 5 per cent slope, severely eroded.

12. **Dabolim:** Soils of Dabolim series is a member of the Loamy, mixed, Lithic Ustorthents. These soils are very shallow, well drained, brown to very dark brown, sandy loam surface soils underlined by hard laterite layer; occurring on flat topped hills of laterites, 1 to 5 per cent slope, severely eroded.

13. **Karmali:** Soils of Karmali series is a member of the Clayey, mixed, Lithic Dystropepts. These soils are shallow, well drained, brown to dark brown, gravelly clay surface soil and strong brown to dark brown, gravelly clay subsoil with cambic horizon; occurring on the flat topped hills of laterites; 1 to 5 per cent slope, moderately eroded.

14. **Karven:** Soils are Karven series is a member of the Clayey-skeletal, kaolinitic, Oxidic Ustropepts. These soils are deep, well drained to somewhat excessively drained, dark reddish brown, gravelly clay surface soil and reddish brown to red, gravelly clay subsoil with cambic horizon and more than 35 per cent coarse fragments in surface and sub-surface horizons; occurring on escarpments of the hill side slopes; 8 to 15 per cent slope, moderately eroded.

15. **Verna:** Soils of Verna series is a member of the Clayey-skeletal, mixed, Lithic Dystropepts. These soils are shallow, well drained, reddish brown to dark reddish brown, gravelly sandy clay loam surface soil and red to dark red, gravelly clay subsoil with cambic horizon and more than 35 per cent coarse fragments; occur on the escarpments of hill side slopes; 8 to 15 per cent slope, moderately eroded.

16. **Chapora:** Soils of Chapora series is a member of the Fine-loamy, mixed, Typic Ustropepts. These soils are deep, well drained, brown to dark brown, sandy loam surface soil and yellowish brown to brown, sandy loam to sandy clay loam subsoil with cambic horizon; occurring on undulating lands of Konkan coast; 3 to 8 per cent slope, moderately eroded.

17. **Zaimolo:** Soils of Zaimolo series is member of the Clayey, mixed, Typic Paleustults. These soils are deep, well drained, yellowish red to dark reddish brown, gravelly clay loam surface soil and red to dark red, gravelly clay subsoil with argillic horizon; less than 5 per cent iron and manganese concretions; occur on undulating lands; 3 to 8 per cent slope, moderately eroded.

18. **Saligao:** Soils of Saligao series is a member of the Clayey-skeletal, mixed, Typic Kanhaplustults. These soils are deep, well drained, strong brown, gravelly sandy clay loam surface soil and yellowish red to dark reddish brown, gravelly clay subsoil with argillic horizon and more than 35 per cent coarse gravels in surface and sub surface horizons; less than 5 per cent iron and manganese concretions; occurs in undulating lands; 3 to 8 per cent slope, moderately eroded.

19. **Batim:** Soils of Batim series is a member of the Fine, mixed, Kanhaplic Haplustalfs. These soils are very deep, moderately well drained, yellowish brown to dark brown, sandy loam surface soil and yellowish brown to strong brown, clay loam to clay subsoil with argillic horizon and less than 5 per cent iron and manganese concretions; occurring in colluvial low lands/narrow valleys; 1 to 3 per cent slopes, slightly eroded.

20. **Devabag:** Soils of Devabag series is a member of the Clayey-skeletal, mixed, Typic Ustropepts. These soils are shallow, somewhat excessively drained, dark yellowish brown, gravelly clay surface soil and dark brown to dark reddish brown gravelly clay subsoil with cambic horizon and more than 35 per cent coarse gravels; occurring on restricted summits of granite-gneissic landform of central Sahyadri; 15 to 30 per cent slope, severely eroded.

21. **Dande:** Soils of Dande series is a member of the Clayey, mixed, Kanhaplic Haplustilts. These soils are moderately deep, well drained, brown to dark brown, gravelly clay surface soil and reddish brown to dark reddish brown, clay subsoil with argillic horizon; occurring on hill side slopes of central Sahyadri; 15 to 30 per cent slope, severely eroded.

22. **Gudi:** Soils of Gudi series is a member of the Fine-loamy, mixed, Ustoxic Dystropepts. These soils are deep, well drained, light yellowish brown to dark yellowish brown, gravelly sandy clay loam surface soil and yellowish brown to

strong brown, gravelly sandy clay loam subsoil with cambic horizon; occurs on hill side slopes of central Sahyadri; 15 to 39 per cent slope, severely eroded.

23. **Netravli:** Soils of Netravli series is a member of the Clayey-skeletal, mixed, Ustoxic Dystropepts. These soils are slightly deep, well drained, dark reddish brown, gravelly clay surface soils and dark reddish brown, gravelly clay subsoil with cambic horizon and more than 35 per cent coarse gravels; occur on restricted summits of quartzite/schistose landform; 8 to 15 per cent slope, severely eroded.

24. **Torse:** Soils of Torse series is a member of the Clayey, mixed, Lithic Dystropepts. These soils are shallow, somewhat excessively drained, brown to dark brown, gravelly silty clay surface soil and dark brown, clay to gravelly clay subsoil with cambic horizon; occur on restricted summits of quartzite/schistose landform; 15 to 30 per cent slopes, severely eroded.

25. **Velge:** Soils of Velge series is a member of the Loamy-skeletal, mixed, Lithic Ustorthents. These soils are very shallow, somewhat excessively drained, brownish yellow to dark yellowish brown, gravelly sandy clay loam surface soil with more than 35 per cent coarse gravels and very dark grayish brown gravelly sandy clay loam subsoil with more than 70 per cent coarse gravels; occurring on low hills; 8 to 15 per cent slopes, severely eroded.

26. **Gavane:** Soils of Gavane series is a member of Clayey-skeletal, mixed, Typic Ustropepts. These soils are moderately deep, somewhat excessively drained, dark brown, gravelly clay surface soil and dark reddish brown, gravelly clay subsoil with cambic horizon and more than 35 per cent coarse gravels; occurring on the hills of central Sahyadri; 15 to 30 per cent slope, severely eroded.

27. **Darbandora:** Soils of Darbandora series is a member of the Very fine, mixed, Ustoxic Humitropepts. These soils are moderately deep, somewhat excessively drained, brown to dark reddish brown, clay surface soil and dark reddish brown to dark red, clay to gravelly clay subsoil with cambic horizon; occurring on high hills; 15 to 30 per cent slope, severely eroded.

28. **Metavada:** Soils of Metavada series is a member of the Clayey-skeletal, mixed, Lithic Dystropepts. These soils are shallow, somewhat excessively drained, dark reddish brown, gravelly clay surface soil and dark reddish brown, gravelly clay subsoil with cambic horizon and more than 35 per cent coarse gravels in surface and sub surface horizons; occurs in low hills regions; 15 to 30 per cent slope, severely eroded.

29. **Bandoli:** Soils of Bandoli series is a member of the Clayey, mixed, Typic Haplustults. These soils are deep, well drained, yellowish red, silty clay surface soil and dark yellowish brown to dark brown, clay subsoil with argillic horizon and less than 5 per cent iron and manganese concretions; occurring in the inter-hilly basin of central Sahyadri; 3 to 8 per cent slope, moderately eroded.

30. **Arukot:** Soils of Arukot series is a member of the Very fine, mixed, Kandic Paleustalfs. These soils are deep, well drained, dark brown, clay surface soil and dark reddish brown to dark red, clay sub soil with an argillic horizon and less than 5 per cent iron and manganese concretions; occurring in the interhilly basin of central Sahyadri; 3 to 8 per cent slope, moderately eroded.

31. **Pali:** Soils of Pali series is a member of the Fine-loamy, mixed Ustic Dystropepts. These soils are moderately deep, moderately well drained, dark yellowish brown, loam surface soil and dark yellowish brown to yellowish brown, loam to clay loam subsoils with cambic horizon and prominent brown mottles with less than 8 per cent iron and manganese concretions; occur in narrow valleys; 1 to 3 per cent slopes, slightly eroded.

32. **Surla:** Soils of Surla series is a member of the Very fine, mixed, Typic Ustropepts. These soils are moderately deep, well drained, brown to dark brown, clay surface soil and brown to dark brown, clay to gravelly clay subsoil with cambic horizon; occur on restricted summits of basaltic landform; 8 to 15 per cent slope, severely eroded.

Soil distribution and classification^[333]

In addition to the soils mapped, these are rock outcrops and laterite crusts associated with the soils. The area under each mapped soil is given in the legend. The soil units associated with rock outcrops cover 0.25 per cent while the soil unit with laterite crust covers 4.4 per cent (refer Goa Soils map).

³³³ National Bureau of Soil Survey & Land Use Planning, *Soils of Goa for Optimising Land Use b. Executive Summary*, p.37

ENQUÊTE NO. X

IDENTIFICATION

Région:

Taluka:

Village:

Propriétaire (s) / Hébergent(s):

Nombre d'habitants:

Adresse:

Technique(s) de construction:

Visité le:

INFORMATION DU BÂTIMENT

DONNÉES CHRONOLOGIQUES

Date de la construction:

Constructeur:

Usage d'origine:

Usage actuel:

Histoire du bâtiment:

Restaurations et/ou interventions:

Bâtiment utilisé or pas actuellement:

Bâtiment en risque:

Information donné par:

Autre information importante:

Perspectives du bâtiment

Terre utilisée & Typologie

Modèle d'enquêtes — Goa (En français)

DONNÉES TECHNIQUES

Soubassement:

Sol:

Contreforts:

Angles:

Ouvertures:

Type de toiture:

Épaisseur du mur extérieur:

Détails architecturaux exceptionnels:

Observations:

DONNÉES TYPOLOGIQUES (pisé / bauge)

Description de la terre utilisée:

Dimensions des couches:

Mortiers:

Enduits, pigments et/ou peintures:

Caractéristiques particulières:

[Dessins par Lionel Afonso, 2018-2019]

Modèle d'enquêtes — Goa (En français)

CONSERVATION ET LONGÉVITÉ

ÉTAT DES LIEUX

Dégâts / problèmes:

Observations:

ENTRETIENS ET REPARATIONS

Conservation préventive:

Interventions périodiques:

Réparations:

Observations:

Autre information:

Contraintes actuelle:

Projet futur du bâtiment:

Survey template — Goa (In English)

SURVEY NO. X

IDENTIFICATION

District:

Taluka:

Village:

Owner(s) / Tenant(s):

No. of inhabitants:

Address:

Construction technique(s):

Visited on:

BUILDING DATA

CHRONOLOGICAL DATA

Construction date:

Builder:

Original use:

Present use:

History of the building:

Restorations and/or interventions:

Building in use or not:

Building at risk:

Information given by:

Other important data:

Perspectives of the building

Earth used & Typology

Survey template — Goa (In English)

TECHNICAL DATA

Base-course:

Flooring:

Buttresses:

Corners:

Openings:

Roof type:

Thickness of exterior walls:

Distinct architectural details:

Observations:

TYPOLOGICAL DATA (rammed-earth / cob)

Description of earth used:

Dimensions of 'lifts':

Mortars:

Plasters, pigments and/or paints:

Distinct characteristics:

[Drawings by Lionel Afonso, 2018-2019]

Survey template — Goa (In English)

Survey template — Goa (In English)

CARE AND CONTINUITY

CONDITION ASSESSMENT

Damages incurred / problems faced:

Observations:

MAINTENANCE AND REPAIRS

Preventive conservation:

Periodic interventions:

Repairs:

Observations:

Other information:

Challenges faced today:

Future plans:



ANNEXES — PORTUGAL

CLIMATE GRAPHS — PORTUGAL

[Source: <http://portaldoclima.pt/en/> (accesed on January 18, 2020)]

Past records and future climate change estimations are presented by the AdaPT programme in support of adaptation to climate change in Portugal.

TEMPERATURE

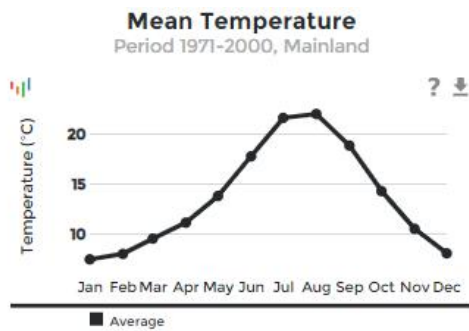

Climate normal: Modeled historical - 1971-2000, Statistic: 30 years average, Global Model: Ensemble, Regional model: Ensemble

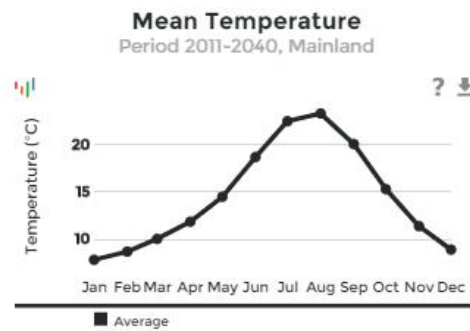

Climate normal: RCP4.5 scenario - 2011-2040, Statistic: 30 years average, Global Model: Ensemble, Regional model: Ensemble

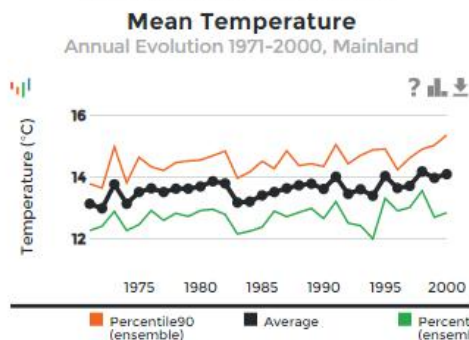

Climate normal: Modeled historical - 1971-2000, Temporal mean: Annual, Statistic: 30 years average, Regional model: Ensemble, Global Model: Ensemble

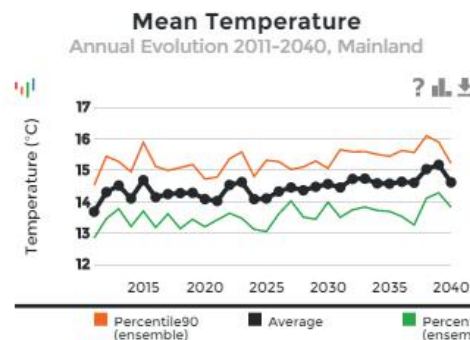

Climate normal: RCP4.5 scenario - 2011-2040, Temporal mean: Annual, Statistic: 30 years average, Regional model: Ensemble, Global Model: Ensemble

Left side: Monthly and annual average mean temperature from 1971 to 2000.
Right side: Monthly and annual average mean temperature from 2011 to 2040 (estimations included).

PRECIPITATION

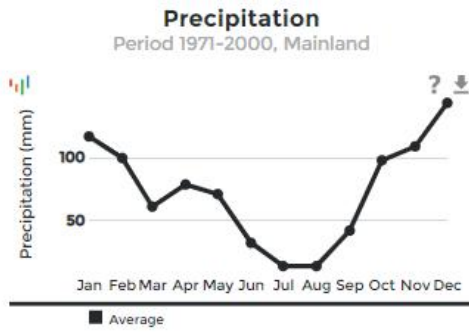

Climate normal: Observed historical - 1971-2000, Statistic: 30 years average

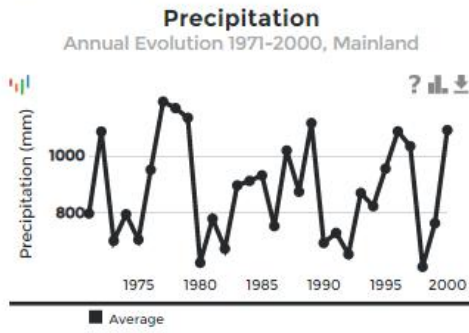

Climate normal: Observed historical - 1971-2000, Temporal mean: Annual, Statistic: 30 years average

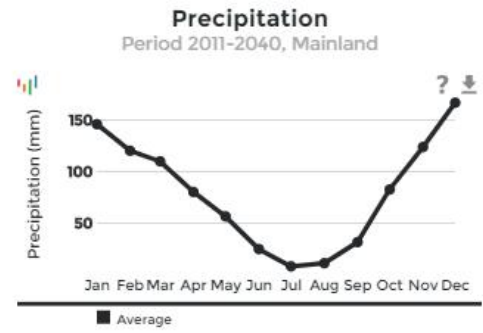

Climate normal: RCP4.5 scenario - 2011-2040, Statistic: 30 years average, Global Model: Ensemble, Regional model: Ensemble

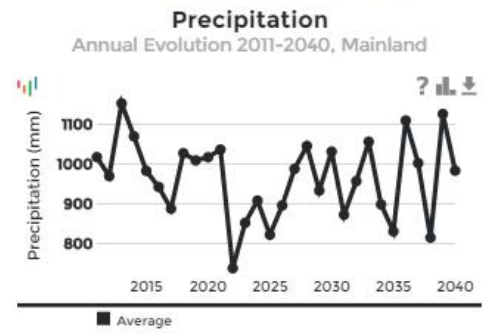

Climate normal: RCP4.5 scenario - 2011-2040, Temporal mean: Annual, Statistic: 30 years average, Regional model: Ensemble, Global Model: Ensemble

Left side: Monthly and annual average mean precipitation from 1971 to 2000.
Right side: Monthly and annual average precipitation from 2011 to 2040 (estimations included).

ENQUÊTE NO. X [X]

IDENTIFICATION

Région:

Municipalité:

Paroisse:

Village le plus proche:

Propriétaire(s):

Adresse:

Accès:

Technique(s) de construction:

Visité le:

Révisité le:

Personne concernée et rencontrée

le:

INFORMATION DU BÂTIMENT

DONNÉES CHRONOLOGIQUES

Date de la construction:

Constructeur:

Usage d'origine:

Usage actuel:

Histoire du bâtiment:

Restaurations et/ou interventions:

Bâtiment utilisé or pas actuellement:

Bâtiment en risque:

Information donné par:

Autre information importante:

Perspectives du bâtiment

Terre utilisée & Typologie

Modèle d'enquêtes — Alentejo (En français)

DONNÉES TECHNIQUES

Soubassement:

Sol:

Contreforts:

Angles:

Ouvertures:

Type de toiture:

Épaisseur du mur extérieur:

Détails architecturaux exceptionnels:

Observations:

DONNÉES TYPOLOGIQUES (pisé / bauge)

Description de la terre utilisée:

Dimensions du pisé:

Mortiers:

Enduits, pigments et/ou peintures:

Caractéristiques particulières:

[Source: Correia, *Le pise d'Alentejo, Portugal*, 2000]

Modèle d'enquêtes — Alentejo (En français)

CONSERVATION ET LONGÉVITÉ

ÉTAT DES LIEUX

Dégâts / problèmes:

Observations:

ENTRETIENS ET REPARATIONS

Conservation préventive:

Interventions périodiques:

Réparations:

Observations:

Autre information:

Contraintes actuelle:

Projet futur du bâtiment:

CHANGEMENTS PRINCIPAUX DEPUIS 2000

En 2000		
En 2018		

Survey template — Alentejo (In English)

SURVEY NO. X [X]

IDENTIFICATION

District:

Municipality:

Parish:

Nearest village:

Building name:

Owner(s):

Address:

Directions:

Construction technique(s):

Visited on:

Revisited on:

Met concerned person on:

BUILDING DATA

CHRONOLOGICAL DATA

Construction date:

Builder:

Original use:

Present use:

History of the building:

Restorations and/or interventions:

Building in use or not:

Building at risk:

Information given by:

Other important data:

Perspectives of the building

Earth used & Typology

Survey template — Alentejo (In English)

TECHNICAL DATA

Base-course:

Flooring:

Buttresses:

Corners:

Openings:

Roof type:

Thickness of exterior wall:

Distinct architectural details:

Observations:

TYOLOGICAL DATA (rammed-earth / cob)

Description of earth used:

Dimensions of the rammed-earth block:

Mortars:

Plasters, pigments and paints:

Distinct characteristics:

[Source: Correia, *Le pise d'Alentejo, Portugal*, 2000]

Survey template — Alentejo (In English)

Survey template — Alentejo (In English)

CARE AND CONTINUITY

CONDITION ASSESSMENT

Damages incurred / problems faced:

Observations:

MAINTENANCE AND REPAIRS

Preventive conservation:

Periodic interventions:

Repairs:

Observations:

Other information:

Challenges faced today:

Future plans:

MAJOR CHANGES SINCE 2000

In 2000

In 2018

***'Taipa'* Houses of Alentejo: Local Building Cultures and Conservation Approaches**

Part of post-master's DSA Earthen Architecture and Heritage (CRAterre-ENSAG – France) dissertation,
'Earthen houses of Goa and Alentejo: Comparison of Local Building Cultures and Conservation Approaches'



'Taipa' house with an oven, Serpa - Alentejo

Report by Chenelle Fatima Rodrigues
Fundação Oriente Scholar, July – September 2018

CONTENTS

COURSE OF ACTION	03
◦ Travels	
◦ Day visits	
◦ Other relevant visits	
MEETING WITH EXPERTS IN EARTHEN ARCHITECTURE	04
◦ In... Mourão	
◦ Moura	
◦ Alcácer do Sal	
◦ Montemor-O-Novo	
◦ Serpa	
◦ Montoito	
◦ Lisbon	
CONDUCTING CASE-STUDIES	05
◦ District: Évora	05
Reguengos de Monsaraz, Aldeia da Luz, Redondo	
◦ District: Beja	07
Moura, Serpa	
◦ District: Setúbal	09
Alcácer do Sal	
FUTURE COURSE OF ACTION / NEXT VISIT	10
◦ Experts in touch with / intend to meet	
◦ Main places to visit to meet locals and experts in mud-constructions and heritage	
◦ Main places to visit for purpose of case-studies	

****This report is a summary of activities during my Fundação Oriente Scholarship period, 20th June – 26th September 2018. As this research is part of my post-master’s DSA Earthen Architecture and Heritage (CRAterre-ENSAG – France) dissertation, ‘Earthen houses of Goa and Alentejo: Comparison of Local Building Cultures and Conservation Approaches’, the final research will be submitted when I complete my degree in September 2019.***

COURSE OF ACTION

Travels:

20th July – 26th September, 69 days

- Lisbon, 11 days:
20th – 22nd July, 4th – 8th August, 18th – 23rd September
- Mourão, 39 days:
22nd July – 4th August, 8th – 13th August, 1st – 18th September, 23rd – 26th September
- Goa, 19 days:
13th August – 1st September

**Visit to Goa was an emergency*

Day visits:

- Evora, Moura and Serpa (7th September)
- Monsaraz (8th, 9th & 24th September)
- Alcácer do Sal (13th September)
- Montemor-O-Novo (15th – 16th September)
- Serpa (17th September)
- Montoito (24th September)
- Faro (25th – 26th September)

Other relevant visits:

- Museu do Oriente, Lisbon
- Castelo de Mourão, especially the remnants of its ancient mud-fortification-walls
- Museu Nacional de Etnologia, Lisbon
- Museu Nacional do Azulejo, Lisbon
- Castelo de Monsaraz
- Cripta Arqueológica do Castelo de Alcácer, Alcácer do Sal
- BION (Building Impact Zero Network) exhibition @ Galeria Municipa, Montemor-o-Novo
- Museu da Luz, Mourão

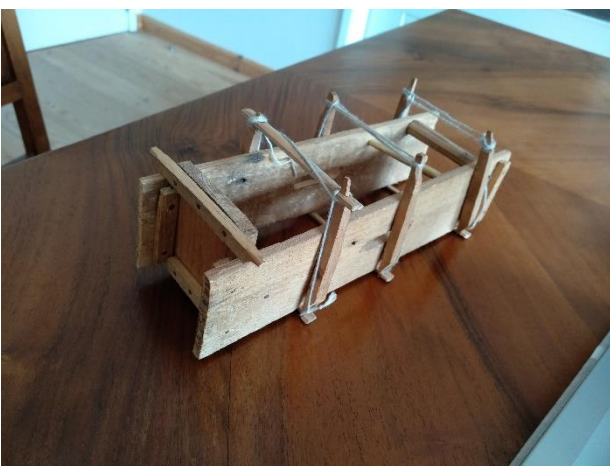

Two differently designed formwork used in the building of mud-walls in Alentejo. Mud walls or houses i.e. those built using the rammed-earth technique are referred to as '*Taipas*' in Alentejo. The long wooden planks of the formwork are called '*Taipais*'.

Figure 1: Miniature model as shown by Architect / mud-construction specialist, Catarina Pereira, Lisbon

Figure 2: Museu da Luz, Mourão

MEETING WITH EXPERTS IN EARTHEN ARCHITECTURE

In... Mourão:

- Carlos Fernandes Alfonso, Architect
- Stéphanie Noël, Interior Architect
- Carla Luz, Architect at Câmara Municipal de Mourão
- Rui, Architect at Câmara Municipal de Mourão
- João, Architect at Câmara Municipal de Mourão

Moura:

- Clara and Filipe @ ADCMoura (engaged in rehabilitation of traditional mud-houses in Alentejo)

Alcácer do Sal:

- António Carvalho, Archeologist @ Gabinete de Arqueologia, Historia e Patrimonio Cultural – Municipality of Alcácer do Sal

Montemor-O-Novo:

- Tania Teixeira, Architect / specialist in mud-constructions

Serpa:

- Paula Estorninho, Architect @ Municipality of Serpa
- António Martins Inácio, *Pedreiro* / traditional mason

Montoito – Redondo:

- Rui mataloto, Archaeologist @ Municipality of Redondo

Lisbon:

- Joana Basta, Architect
- Simão Leandro, Architect
- Catarina Pereira, Architect / specialist in mud-constructions
- Ângelo Silveira, Architect at Direção-Geral do Património Cultural (DGPC) / Author: A Casa-Pátio de Goa
- Maria Fernandes, DGPC / specialist in mud-constructions
- Miguel Mendes, Architect / specialist in mud-constructions
- Paulina Faria, Professor @ Faculdade de Ciências e Tecnologia da Universidade Nova de Lisboa (Studies on rehabilitation of traditional mud-houses)
- Victor Mestre, Architect / PhD Vernacular Architecture of Goa

- Milena Calvário Raposo, Architect
- Joaquim Baptista, *Pedreiro* / traditional master-mason

Ms. Milena is based in Lisbon but had visited Mourão, where she is working on refurbishing an old house partly built with mud. I had the opportunity to meet her both in Mourão and Lisbon.

Mr. Joaquim is originally from Mourão but lives in Lisbon. I had the opportunity of meeting him several times, both in Mourão and Lisbon. A mason himself, his first-hand experience with building mud-structures has given me an in-depth understanding of traditional mud-building, particularly in Mourão.

CONDUCTING CASE-STUDIES

I had a list of about 40 mud-houses situated in Alentejo (ref. Architect Mariana Correia's research, 1998-2000), and intended to select about 15 – 20 of them as case-studies for my research. I managed to visit 26 houses and meet people in connection with 14 houses. Thus, I have data to include about 14 case-studies in my research.

District: Évora

◦ **Reguengos de Monsaraz**

(Visited 8 houses, met people in connection with 5 houses)

1. *Monte da Coutada*
(Spoke to Maria Vicência Oliveira Patrício – owner)
2. *Monte Novo da Coutada*
3. *Monte Santa Catarina*
(Spoke to Maria V. Duarte – current owner's daughter)
4. *Casa da Moagem*
(Had a brief chat with owner's relative)
5. *Monte do tio Zaqueiro*
Monte do Branquinho
6. *Monte da Bulhoa*
(Spoke to António Morais – farmer and neighbour)
7. *Olaria: O Patalim*
(Spoke to Nelia Santos – owner's grand-daughter)

◦ **Aldeia da Luz**

(The village of Aldeia da Luz was destroyed to make place for the Alqueva Lake, met people in connection with 3 houses that existed in the former village.)

1. *Tapada das Vacas*
(Spoke to Antónia Rosa dos Ramos – an old neighbour)
2. *Ramada na Estrada da Tapada*
(Spoke to Leonel – owner)
3. *Ramada na Estrada da Estrela*
(João Vidigal – owner's grand-son)

◦ **Redondo**

(Visited 4 houses, met people in connection with 3 houses)

1. *Adega do Monte das Castilhas*
(Spoke to Florbelle Fernandes – an old neighbour)
2. *Monte das Castilhas*
(Spoke to Florbelle Fernandes – old owner's daughter)
3. *Monte da Azinheira*
(Maria Joana De Conceição Pereira – tenant)
4. *Monte Pirinéu*
(*Possibility of talking to owner)



Figure 3:
External wall of 'Taipa'
and internal division
wall in 'adobe' bricks.

*Monte da Coutada,
Monsaraz*



Figure 4:
Typology of a 'Taipa'
house in Serpa.

Monte Pirinéu, Serpa

District: Beja

◦ **Moura**

(Visited 4 houses and met people in connection with 2 houses)

1. *Cabana de vacas do Monte Valvinagrinho*
(Spoke to António Paulo Bicho – owner)
2. *Casa dos Trabalhadores do Monte Valvinagrinho*
(Spoke to António Paulo Bicho – owner)
3. *Casa de Ciganos*
4. *Oficina de Abugão*

◦ **Serpa**

(Visited 4 houses, met 2 people in connection with 1 house)

1. *Casa do Monto da Cruz de Cigana*
2. *Vacaria do Monte do Ti Zé Marques*
(*Possibility of an interview with the owner)
3. *Monte das Fontainhas*
4. *Monte dos Sobreiros*
(Spoke to Margarida Silvestre – neighbour, António Martins Inácio – Builder and mason)



Figure 5: A 'Taipa' house with buttresses, which were probably built to keep the 'Taipa' wall from falling.
Casa dos Trabalhadores do Monte Valvinagrinho, Moura



Figure 6: Whitewashed 'Taipa' walls of *Pedreiro*, António Martins Inácio's house. '*Pedreiro*' is the Portuguese word for 'mason'. António Martins Inácio is a traditional mud-mason.
Serpa



Figure 7: *Pedreiro* António Martins Inácio and his wife outside their 'Taipa' house.
Serpa

District: Setúbal

◦ **Alcácer do Sal**

(Visited 3 houses and in touch with 1 person in connection with 1 house)

1. *Monte do Courela*
(*Possibility of talking to owner)
2. *Monte do Passareiro*
3. *Casas dos Romeiros*
(*Possibility of talking to architect)



Figure 8: A recently plastered 'Taipa' house
Casas dos Romeiros, Alcácer do Sal

FUTURE COURSE OF ACTION / NEXT VISIT

Some experts I am in touch with / intend to meet:

- Mariana Correia, Architect / specialist in mud-constructions, Vila Nova de Cerveira
- Isabel Pinto, Câmara Municipal de Elvas
- Francisco Seixas @ Betão e Taipa, Serpa
(Engaged in rehabilitation of mud-houses / construction of contemporary earthen-structures)
- Miguel Rocha, Serpa
(Engaged in earthen-architecture training, especially for artisans)
- Claudio Torres, Director / Archeologist @ Campo Arqueológico de Mértola
(Well-versed with ethnographical understanding of traditional mud-buildings in Portugal)
- Henrique Scherec, Architect / specialist in mud-constructions, Odemira
- Mestre António known as 'Bailhatoque' OR his nephew, *Pedreiro* / Master-mason, Odemira
- Alexandre Bastos, Architect / specialist in mud-constructions, Odemira
- João Bernardino, Eco-builder, Santiago do Cacém

Main places to visit to meet locals and experts in mud-constructions and heritage:

- Viana do Castelo: Vila Nova de Cerveira
- Portalegre: Elvas, Sousel
- Beja: Serpa, Mértola
- Setúbal: Santiago do Cacém, Odemira

Main places to visit for purpose of case-studies:

- Beja: Almodôvar, Ourique
- Setúbal: Santiago do Cacém

Research Topic:

Earthen Architectural Heritage in Goa (India) and Alentejo (Portugal): Local Building Cultures and Conservation Approaches.

Profiles – Builders:

Joaquim Antonio Baptista

Age: 79 (born in 1939)

Address: 16, Rua da Pereira, Mourão



Picture 1: Street in Mourão with 'Taipa' houses

Picture 2: *Pedreiro* Joaquim Baptista showing some of his old tools used for mud-building
(Picture taken in July and August 2018)

Joaquim's family have been masons since the 18th Century (What's *Alvaréo*?). For some years, Joaquim also took on the profession of a sailor. His son, Diocleciano, a lawyer, is the first to have not followed the tradition.

Joaquim is very happy to share his knowledge of 'Taipa' buildings as he wants this art to survive. It was kind of him to even make a cardboard model of the 'Taipa' formwork, draw pictures of each part of the formwork and write text to share with me. In one of his writings, he stated that his family, for many decades till the present generation followed the profession of bricklayers (*Alvanéus* in other times), and that his family would like that this practice and the tools associated with it, do not stand forgotten and that the future generations carry on this knowledge.¹

¹ The exact words of JB are "*Por descendermos de famílias que durante muitas décadas a até à presente geração trabalharam e tinham como profissão o ofício de pedreiros (alvanéus noutros tempos), gostaríamos que tais utensílios não fossem esquecidos e que também as gerações futuras deles tivessem conhecimento.*"

Profiles – Villages:

Mourão

Mourão is a village in the East of Alentejo, along the Portugal-Spain border, with a population of about 2,500 inhabitants. The temperature ranges from about 3°C – 30°C between winters and summers, January being the coldest and July-August being the hottest months.

The structures in Mourão are mostly built with mud as has been the case since XX Century. The 17th Century bastions (*Baluartes*) of Mourão's Castle, which were built based on the Vanban system were built with mud. These bastions were built on orders of the Queen after the prior fortification wall was destroyed during the 1657 war. Then, the village of Mourão was confined to a few houses situated next to the castle. The village was protected by another fortification wall, the remnants of which are still seen within the village, as Mourão has of course spread beyond the then fortification walls. Some remnants of this wall include the backyard boundary wall of Joaquim Baptista's house at 16, Rua da Pereira, Mourão.

The structures in Mourão are mostly built using the 'Taipa' technique, the base of the walls i.e. up to 80cms are built with Xisto stones. Compound walls too, are built in the same technique with Xisto covering the top to protect it.

In XXX year, in Mourão, soil was extracted from site when building a house. However, red-coloured particles with tiny particles of Xisto was considered the best for 'Taipa' constructions. Bricks were generally made of this soil too. This red-coloured earth was got from the right side of the highway in Hortinho, which then belonged to the Rojãs family. Today, ETAR, the sewage treatment plant, stands on this ground.

In the XX Century, there used to be ovens to bake roof tiles ('telhas') and bricks ('tijolos), and to make lime to whitewash. Families, such as that of João Rosado in Mourão, who owned big estates had their own, private ovens to allow production for private use. This was especially in areas of Relvas, Albufeira and Ameadas. Lime/whitewash was made from limestone, which was abundantly found in Mourão. Mourão stopped producing lime in the XX Century as people started sourcing it from Borba, a village in Northern Alentejo, where it was made from marble. In Mourão, there are families with the surname 'Caleiros' which indicates that they come from a family that were traditionally involved in the producing lime, as in Portuguese, 'cal' means 'lime'.

'Taipa' buildings were built until 19XX, and this building-craft is almost lost in the village. A few artisans, who are too old to practise the craft survive, but the craft is no longer in demand.

Building Technique:

Foundation and wall base:

Foundations are built using Xisto, which may be naturally found as huge rocks; fairly flat and tile-like pieces; and small stones.

When big slabs of Xisto rocks are sometimes seen on the surface, the foundation is directly built over the rock. If not, the ground is dug about 50-60 cms deep and XX cm wide, and the foundation is constructed with Xisto masonry. The fairly flat and tile like pieces are used for this masonry.



← Digging the ground in Mourão to find the depth at which the rocky ground is found. This depth determines the depth of the foundation and is likely to differ from area to area, even within the same village. (Picture taken in August 2018)

Whether one chose to use mortars or not, depended on their economic situation. In general, the rich used mortars made by mixing lime and sand, the middle-class used soil and straw, and the poor opted for dry-stone-walls i.e. masonry with no mortars. The stone-masonry continued to about 80 cms above ground level, thus forming the wall-base.

Tools used for ‘Taipa’ constructions:

‘Taipa’ is a technique of building structures by ramming earth between a temporarily-set, wooden mould. Walls are built in successive ‘lifts’ i.e. one ‘lift’ at a time, and each above the other.

A typical mould, as Joaquim explained and demonstrated through a simple cardboard model and illustrations he made (refer to illustration on page XX), consist of the following:

- 1 – Taipas (two nos, made of wood)
- 2 – Agulhas (three nos, made of iron)
- 3 – Comportas (two nos, wood)
- 4 - Costeiros (six nos, wood)
- 5 - Cadeias (three nos, wood)
- 6 – Maços (two nos, wood)
- 7 – Côvados (two nos, wood)
- 8 – Cunhas (several in nos, wood)

1. ‘Taipais’ / shutters, 2 nos

Interestingly, the part of the mould i.e. the wooden shutters used along the length of the mould is called ‘Taipais’, similar to ‘Taipa’, the construction technique. Each of these wooden shutters are

made using two horizontal wooden planks (about 2 – 2.2 m in length, 55 cms height and 0.25 – 0.30 cms thickness), held together by two vertical timber towards both the ends of the shutter. Both vertical timbers are not fixed on the same side of the shutter; one is fixed on the one side, and the other on the other. The shutters are designed to have an opening in the middle of the shutters to allow easy handling, while mounting and unmounting the formwork.

As the shutters were made of wood, the moisture in the soil along with the frequent ramming, made the shutter vulnerable to warping. In order to reduce this risk, two wooden planks – instead of one – were used to create a single shutter; this division allowed to divide the pressure the wooden shutters took as a result of ramming. In addition, while mounting and unmounting the shutters for building different parts of the 'lift', the shutters were interchanged to face inward and outward in order to distribute the impact of moisture and ramming.

2. 'Comportas', 2 nos

Side-shutters. Three were usually 2 sets of side-shutters (50 cms and 60 cms breadth) to allow options of wall thickness. These shutters also had horizontal wooden timbers, the one on the top was longer. Side-shutter were placed on both the ends of the mould, and thus closed and formed a box-shape mould. The side-shutters were placed inside the long shutters, and the bigger horizontal timber served as a stopper and secured the position of the side-shutter.

3. 'Cadeira', 3 nos

This was in the shape of an arch so as to allow space for ramming. (80 cms). This had two openings in each of the three pieces to allow it to fit around the upper, thinner part of the 'Costeiros'. The 'Cadeira' was then further secured using the 'cunhas' / 'wedges', which were put either in the inside or the outside so as to achieve an increased or decreased wall width.

4. Agulha, 3 nos

This cylindrical rod/needles was the only part of the mould that was made of metal, though prior to that it was made from wood. It had a stopper on one end and three holes on the other end, through which stoppers could be inserted as per the desired thickness of the wall. (80 cms of width and several holes to provide options to increase/decrease the wall width).

5. Còvados, 2 nos

These simple, cylindrical rods/needles that acted as spacers. They were fitted, breath-wise, along the insides of the mould in order to ensure that the space maintained between the two long shutters stayed uniform. It also aids ensuring that the 'Taipais' don't collapse inwards.

6. Wedges, several in nos

These were placed either towards the interior or exterior, depending on the desired wall thickness. They aided in securing the stability of the mould when mounting, and when taken-off, allowed for easy sliding out of the shutters and thus easy unmounting of the mould.

7. Costeiros, 6 nos

(70 cms in height). These had a spilt at the bottom to allow to be set securely on the 'Agulhas'.

8. Maços, 1 nos

The soil used for 'Taipa' constructions was the one naturally found in Mourão i.e. mud along with Xisto. The soil was dug out and stocked in a pile. Smaller Xisto pieces were retained while bigger ones, if found, were set aside. However, red coloured earth that contained tiny particles of Xisto was considered the best for 'Taipa' constructions.

Three pits are made into the extracted mud pile, water is poured into them, and the soil was mixed using a hoe until it was in a 'humid' state. After mixing, the soil is tested by taking a handful of soil and squeezing it in your palm. If it takes a shape but does not entirely stick to your palm, the mud is considered ready for constructional use.

Two men: one man, a helper, who does the mixing. And the other, the master / mestre, who checks and approves the soil consistency.

Like for the construction of the foundation, construction of walls too differed depending on one's economic situation. Among the rich, they used to put a layer of fired bricks after the completion of each 'lift' in order to make the building more resistant. These bricks were placed horizontally, along the interior and exterior edges of the 'lift' only. The middleclass would use a layer of sand and lime mix (3:1), while the poor would not have any bonding layer.

The moulds were demounted after the rammed layers of dry.

Other tools:

Soil was transported from the mud pile to the building being constructed, in baskets made from branches of olive trees. The baskets (dimensions?) were circular in shape and had handles.

A support, circular in shape and made from fabric, was placed over the head, over which the basket of soil was placed.

Line of production:

1 person to mix soil using a hoe. The other the check humidity.

Bricks:

Sun-dried bricks (ladrilhos?) and fired bricks (tijolos?) were used in Mourão. Bricks were placed up to a height of about 80 cms. Both kinds of bricks were made using red-coloured soil that was sieved and thus did not contain stones like the Xistos in 'Taipa'. Sun-dried bricks were cheaper.

(Bricks cooked / raw. 0,25 x 0,12 x 0,08 */-

Tiles had only cooked. 0,25 x 0,12 x 0,04)

Flooring:

Flooring in 'Taipa' houses were made from naturally found, big slabs of Xisto.

If the Xisto naturally occurred within the interior space of the wall it was trimmed to shape and

retained. If not, Xisto was cut and shaped, into flat and squared blocks, and directly placed on the ground to serve as flooring. There was no binding agent used between the ground and Xisto as the blocks were heavy enough to be held securely to the ground. The spaces in between were filled with gout.

In order to cut the Xisto rocks into square shape, each line of the square was first marked by chiselling it out using a hammer. The cut created was '1 finger'* i.e. about 6 cms deep. This was followed by boring 2 or 3 holes along this line, and filling it with gunpowder. The stone would then break open exactly along that line.

Window and door framing:

Each family of artisans had their own style/shape of door frames, which saved as a trademark.

Roofs/ceilings:

In addition to woodwork and country tiles, different kinds of vaults were built to serve as ceilings / roofs.

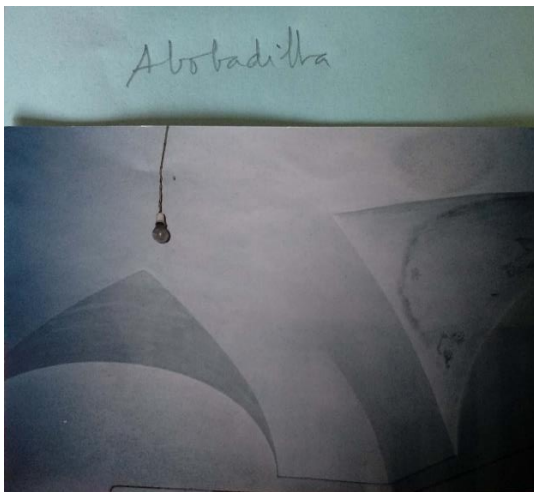

Two types of *Abobadilha* vaults

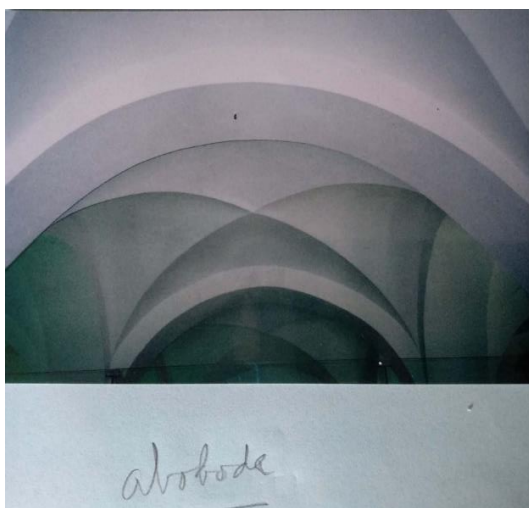

← *Aboboda* vaults (Pictures of vaults sourced from *Pedreiro Joaquim Baptista's* collection)

Renders and Plasters:

A mix of lime and sand was used to render external walls. Two trowels were used for the application of the render... The render consisted of 2 layers. The first layer i.e. the layer below, was about 6 cms (calculated as '1 finger'² by the constructor³) thick and the size of sand particles were bigger. The second layer, which formed the surface layer was about 2 – 3 mm thick and consisted of thinner particles in order to have a smoother finish. The first layer i.e. the thicker of the two was applied using a spoon and leveller, while the second was applied using a spoon and a float.

Paints and Pigments:

Before, houses used to be painted in either of these four colours: blue, ochre, grey or red. The blue came from XXX, the ochre from XXX, the grey from XXX and the red from the earth.

However, In the last 60 – 70 years ago, people started using only white on the exterior of the houses. And in the last 30 – 40 years ago, they shifted to using white in the interiors as well.



Remnants of traditional red and blue pigment paints on houses in Mourão.
(Picture taken in July and August 2018)

² '1 finger' is a unit of measure

³ We use the word 'Constructor' rather than 'Bricklayer' here as it seems more appropriate.



A partly-collapsed building exposing an internal walls of an old, 'Taipa' house. Blue pigment paint seen.
(Picture taken in July and August 2018)

Interventions:

Annual application of lime: Every year, during the summer, the population of Mourão would gather to apply a new layer of lime. This was often during the days before the local feasts. In most villages, the local feasts took place during the months between July to September like the feast of Nossa Senhora da Luz in the village of Aldeia da Luz. In Mourão, however, the village feast i.e. of Nossa Senhora das Candeias is celebrated in February. Application of lime was done early in the morning to avoid the heat.

It was the women who did the whitewashing every year as the women took pride in their house being in perfect condition. One villager recalls a lady in Odemira who would paint the walls next to the fireplace where she would cook, every day. However, she does articulate that that was an exceptional case, and that this was not a trend.

Before, every year during the summer, people used to whitewash their walls. Now, as many people are working, they find little time to do so. As paint stays for many years, and does not need redoing on a yearly bases, people choose to colour their walls with white paint rather than with lime (*cal*). Besides being time-consuming, today, whitewashing walls is more expensive than merely applying white paint. Many people also opt to plaster walls with cement as it is a typical and mainstream

material that is easily available and easy to use. An architect remembers that when she was young, in her village in Sousel, people would whitewash their walls every year, but that is not the case anymore. Then, people would buy limestone and prepare the lime at home as many house-owners had the machinery to make the lime. Almost everybody in the village would have some lime at home. She recalls her grandmother would always store some lime in the garden, and if she sees any stain on the walls of her house, she would repaint that part of the wall.

In the past, many methods were used to avoid insect infestation on roof woodwork such as soaking the wood in a liquid (?) in order to avoid insects. Oil from cars was applied on wooden roof work to preserve it. Now ready-to-use products, available at super markets is used. At a house that is currently being renovated in Mourão, the architect has chosen to paint the roof's woodwork with a tint of colour that keeps the natural look of the wood. (Elaborate)

Joaquim changed the shape of a doorway, which had a flat lintel to one with an arch in order to increase the height and make the doorway more comfortably accessible. Calculations: Length of the lintel, divide by 2, increase height of by half the length. (e.g. if the length of the lintle was 1 m, you increase the height of the doorway to form an arch by 0.5 m.)

Repair:

In case of a hole, mud was mixed with Xistos and roof-tile pieces and filled-up. In case of cracks, the cracks were opened-up a little more, and then filled-up using a mix of mud-Xisto-rooftile pieces

When the building is made of good quality mud, 'Taipa' has no problems. Building of 3 floors built in Mourão almost 70 years ago still stand and show no signs of damage.

Some analyses:

- Rammed-earth needs less water than adobe, and there isn't much water in Alentejo. So most buildings are built in rammed-earth. As a comparison, in Morocco, Algeria, etc., there is adobe near the oases and rammed-earth around the area. After all, it is easier to carry the 'Taipa' formwork than to carry water. Adobe needs more space too.
-

Terminology in English-Konkani-Portuguese:

English	Konkani (Goa's official language)	Portuguese
Brick	<i>chiro (s) / Chire (p) ??</i>	
Fired bricks		<i>Tijolo Cozido/cru</i>
Bricklayer	<i>Pedrel</i>	<i>Pedreiro / Alvanéus (old word, used till about 19th Century)</i>
Sand	<i>Rèuñ / coarse</i>	<i>Areia</i>
Layer		<i>camada</i>
'Lift'		<i>Fio de taipa</i>
Foundation of house	<i>Bunyad</i>	<i>Fundação</i>
Mortar		<i>Massa</i>
Tiles		<i>Ladrilho</i>
Stone	<i>Fator</i>	<i>Pedra</i>
Width		<i>Largo</i>
Height		<i>Altura</i>
Lime	<i>Chuno</i>	<i>Cal</i>
		<i>Taloche??</i>
Hoe	<i>Hore</i>	
Hole	<i>Burak</i>	<i>Burak??</i>
	<i>Beto</i>	<i>Betão</i>
Municipality	<i>Câmara</i>	<i>Camara</i>
Estates	<i>Bhat</i>	<i>Herdades</i>
Sieve (particular type?)		<i>Joeiro</i>
Shutters	<i>Taipas</i>	
	<i>Agulhas</i>	
	<i>Comportas</i>	
	<i>Costeiros</i>	
	<i>Cadeias</i>	
	<i>Maços</i>	
	<i>Côvados</i>	
Wedges	<i>Cunhas</i>	
Wood	<i>Madeira</i>	<i>Moder</i>
Carpenters	<i>Sutars⁴</i>	
Blacksmiths	<i>Lohars⁵</i>	
Tin and coppersmiths	<i>Kansars⁶</i>	
Carpenter	<i>Thovoi (Southern Goa)⁷</i>	
Carpenter	<i>Chari (Northern Goa)⁸</i>	

⁴ Pandit, *Hidden Hands: Master Builders of Goa*, p.87

⁵ Ibid., p.87

⁶ Ibid., p.87

⁷ Ibid., p.88

⁸ Ibid., p.88

Master (craftsman) (The Portuguese in Goa referred to both, masons and Carpenters)	<i>Mestre / Fishaal</i> ⁹	
“...Goan Master Mason Luis Fernandes “Pausekar” ... Referred to as Maestre Pedreiro or Master Stonemason,” Pandit, <i>Hidden Hands: Master Builders of Goa</i> , p.89		
Pick-axe (was used for the excavation and cutting)	<i>Pikander</i> ¹⁰	
Low axe (used for the dressing of the stone)	<i>Moz</i> ¹¹	
A kind of a large hammer	<i>Ghan</i> ¹²	
Cord made from coconut fibre	<i>Dhori</i> ¹³	
Master Masons took immense pride in this fine stonecraft and those interviewed were emphatic about the use of the prefix <i>Mestre</i> or <i>Mistri</i> with their names. ¹⁴		
Sawers of timber	<i>Serradors</i> ¹⁵	
Landowners	<i>Bhatkars</i>	
“Mestre” in Portuguese or “Gavandi” in Konkani ¹⁶		
...consulted the priest or <i>bhat</i> (depending on whether it was a Catholic or a Hindu house that was being constructed) with regard to the positioning of the alter or <i>devaghor</i> . The Hindu priest would decide in favour of the <i>devaghor</i> facing the East or South-East and the Catholic priest would decide in favour of the chapel or alter facing the village Church, roadside chapel or Cross Station. Once decided, the location was referred to by the mastermason and his workers as “uzvi kode” or “the right side”. ¹⁷		
Trowel	<i>Thapi</i> ¹⁸	
Plumb line	<i>Olamba</i> ¹⁹	
Pickaxe	<i>Pikandar / pikao</i> ²⁰	
Planer	<i>Chipni</i> ²¹	
Basket	<i>Patli</i> ²²	
Corner piece	<i>Katkon</i> ²³	
Long wooden bar to level plasterwork	<i>Kam</i> ²⁴	

⁹ Pandit, *Hidden Hands: Master Builders of Goa*, p.88

¹⁰ *Ibid.*, p.93

¹¹ *Ibid.*, p.93

¹² *Ibid.*, p.93

¹³ *Ibid.*, p.93

¹⁴ *Ibid.*, p.94

¹⁵ *Ibid.*, p.94

¹⁶ *Ibid.*, p.105

¹⁷ *Ibid.*, p.105

¹⁸ *Ibid.*, p.106

¹⁹ *Ibid.*, p.106

²⁰ *Ibid.*, p.106

²¹ *Ibid.*, p.106

²² *Ibid.*, p.106

²³ *Ibid.*, p.106

²⁴ *Ibid.*, p.107

Brief of some conclusions drawn so far:

Some similarities between the mud-buildings in Goa and Alentejo:

1. 'Taipa' technique of construction present in Goa and Alentejo
(Subtopic: construction technique)
2. Certain terminology like 'Taipa' is used both in Goa and Alentejo
(Subtopic: Terminology)
3. 'Finger', as a unit of measure was traditionally used both in Goa and Alentejo
(Subtopics: unit of measure)
4. Ladders were used for climbing as walls were built higher
(..as opposed to aiming mud-balls from the ground like in Africa or other methods)
(Subtopic: Tools and equipment)
5. Baskets were used for transporting soil from pile to wall, type of baskets different
(Subtopic: Tools and equipment)
6. Painting/plastering just before the village feasts (cases in Goa and Alentejo)
(Subtopic: Lifestyle practices)

Differences between the mud-building-conservation techniques in Goa and Alentejo:

<u>Sr. No.</u>	<u>Goa</u>	<u>Alentejo</u>
1	Women did the carrying of mud from pile to wall (Subtopic: Gender roles)	Women not involved in building, except cutting of blades of grass in field
2	Earthen chimneys?? (Subtopic: Structural elements)	Earthen chimneys
3	Soil treated before it was used for building (Subtopic: Treatment of building soil)	Soil not treated before it is used for building
4	Soil from field (Subtopic: Sourcing building soil)	Soil from site
5	Mud from the field was shaped into balls and left to dry. The appearance – or not of cracks would decide the quality of mud (Subtopic: Soil testing)	After mixing, the main constructor would check if the soil had the exact humidity to make the 'Taipa'
6	Small baskets were made of bamboo. (Subtopic: Tools and equipment)	Big baskets with handles were made with branches of olive trees.
7	Wall base is thicker, sometimes made of laterite stones.	Wall base of Xisto stones.

	(Subtopic: Materials, construction techniques)	
8	Dimensions of sun-dried bricks – larger (Subtopic: Bricks)	Dimensions of sun-dried bricks – smaller
9	Periodic conservation: use palm leaves (Subtopic: conservation)	Periodic conservation: lime wash
11	Local terminology (Subtopic: terminology)	Local terminology



Arquitetura Chenelle Rodrigues estuda uma antiga vacaria de taipa em ruína na zona de Vales Mortos. Ao lado casas de terra habitadas na região de Goa, Índia.

Arquitetura de taipa entre Goa e o Alentejo

Conservadora indiana visita o Baixo Alentejo no âmbito de uma pesquisa sobre a arquitetura vernacular em taipa de Goa e Alentejo: técnicas de construção e abordagens de conservação

Chenelle Rodrigues é uma conservadora de património indiana, de Goa, e esteve no Alentejo para investigar a construção em taipa, seguindo um estudo realizado há 25 anos por uma arquiteta portuguesa, Mariana Correia. Com o objetivo bem definido de comparar as casas de terra portuguesas com as de Goa, o que será que realmente motiva uma estudante de um curso de pós-graduação em arquitetura e património em terra, no laboratório "CRATERE", da Escola Superior de Arquitetura de Grenoble, a viajar milhares de quilómetros para trás e para a frente, entre Goa e Serpa, com França pelo meio? E se todas as distâncias percorridas e diferenças encontradas convergissem afinal para um e o mesmo lugar, o lugar do humano?

TEXTO E FOTO RUI CAMBRAIA

O *Google Maps* não conhece o caminho marítimo para a Índia e é incapaz de calcular o trajeto rodoviário entre Beja e Goa, mas a *Internet* não nos deixa ficar mal e lá descobrimos que se percorrem 10 774 quilómetros de estradas que atravessam 10 países. Em 1497 Vasco da Gama fez o trajeto a partir de Lisboa chegando a Calecute

cerca de 11 meses depois, a bordo da nau "São Gabriel", liderando uma armada de quatro navios orientados por cartas de marear, quadrantes e astrolábios. Em 1510 os portugueses estabeleceram em Goa a capital do Estado Português da Índia. Passados 520 anos de ligação histórica entre os dois países, agora em pleno século XXI quando podemos visualizar

qualquer cidade do mundo em 3D à distância de uma dedada num smartphone, o único itinerário real entre o lugar onde estamos e o lugar para onde queremos ir continua a ser o caminho da vida.

Chenelle Rodrigues, de 29 anos, natural de Goa, chegou ao Alentejo em julho deste ano, orientada por um enorme livro de teor académico. "O estudo Taipa no Alentejo, da arquiteta Mariana Correia [2000], deu-me indicações precisas. Eu não falo português e não conheço Portugal, se eu tivesse que vir à procura das casas em taipa seria todo um exercício de raiz. E porque existia um trabalho anterior foi muito mais fácil mostrar às pessoas todos estes edifícios sobre os quais eu já tinha informações – já tinha por onde começar", afirma Chenelle.

Conservadora de património na Índia e investigadora em Grenoble,

França, com uma bolsa da Fundação Oriente em Goa, o seu projeto de pós-graduação assenta num estudo comparativo entre a construção em taipa e as casas de lama de Goa e a construção em taipa existente no Alentejo. O objetivo principal é compreender a tipologia e o nível de influência da arquitetura em taipa portuguesa na arquitetura da terra em Goa – o modo como as casas estão organizadas, o simples entendimento de como foram construídas, as técnicas de construção, "pretendo saber até que ponto têm influências portuguesas, até que ponto houve apropriação da arquitetura portuguesa ou não".

Um segundo objetivo, que diz respeito à formação de base de Chenelle, a conservação de património, reenvia para os aspetos qualitativos das técnicas de construção; por um lado verificando o estado atual das construções

anteriormente catalogadas pela arquiteta Mariana Correia, 25 anos depois, procurando compreender se as casas de taipa são melhores em Portugal ou em Goa, que tipo de problemas apresentam, que género de manutenção é realizada e com que frequência, e partilhar esse conhecimento já adquirido em prol de um melhor futuro para estas casas – para uma melhor conservação destas casas. Chenelle Rodrigues não pretende alimentar uma ideia de arquitetura sustentável, ambiental e economicamente aliçada num regresso aos métodos artesanais de construção em terra – apesar de, como sublinha, ser interessante pensarmos que uma casa em taipa abandonada, desprotegida e exposta aos elementos desfaz-se lentamente e a terra volta à terra. É sobretudo na perspetiva da conservação, da longevidade das construções, mantendo-as por mais tempo, que assenta



Acho que o Alentejo é muito parecido com Goa, e não é necessariamente por causa de um edifício, da arquitetura ou da paisagem, mas sobretudo a forma de ser das pessoas, não sei, os ambientes dos lugares”.



prestável senhora que trabalha na bomba de gasolina da N265, entre Vales Mortos e Vale do Poço, descobre-se que o pedreiro que construiu uma das casas em taipa ainda está vivo, “nos seus 70 e poucos”, diz-nos sem certezas, e que habita relativamente perto. Com alguma sorte percebe-se qual a estrada em terra batida por onde temos que entrar, e não sendo afinal na primeira casa com um grande eucalipto à frente, mas sim na segunda com um eucalipto ainda maior, Chenelle chega à fala com António Martins Inácio, pedreiro desde sempre: “Setenta? Já tive...”, e mais não diz sobre o assunto. E sobre a construção daquela que foi efetivamente a sua última obra em taipa também não desenvolve muito. Na verdade o ofício da construção aprendia-se com mestres mas era uma atividade de conhecimento empírico; não havia propriamente fórmulas para preparar a terra, nem grande rigidez nas proporções entre cal e areia para os rebocos, e nas medidas de comprimento, entre o metro e o olho, talvez prevalecesse o olho. “Era conforme o trabalho”, repete António a cada pergunta de caráter técnico de Chenelle. E acrescenta: “O mais importante é a terra ser bem batida, ser molhada num dia e utilizada logo no dia seguinte”. Eram usadas caixas em madeira, cofragens, que numa fiada avançavam num sentido e na fiada seguinte avançavam no sentido contrário, para lá e para cá, sempre assim a toda a volta da casa. As juntas das fiadas de cima ficavam desencontradas das da fiada de baixo, como acontece hoje com os tijolos. A terra não podia ficar nem muito molhada nem muito seca. E tal como suspeitávamos, para medir o grau de humidade e agregação da terra o processo era empírico: “Agarrava-se um punhado e apertava-se com força, se ficasse bem ligada sem fazer bolhas nem escorrer água é porque estava boa”.

A terra retirava-se do terreno em volta da casa, não era preciso escavar

muito fundo, escavava-se à superfície e a água não faltava nos inúmeros poços que existem nas propriedades. Os rebocos eram feitos de cal e areia, em proporções variáveis – “conforme o trabalho” –, areia que se encontrava em abundância nos pequenos cursos de água que abundam por ali – a “água traz muita areia”, diz-nos António, e deposita-se em pequenos assoreamentos de onde é fácil retirar. Eram precisos à volta de cinco homens para construir uma casa: dois para bater a terra, outros dois para a escavar e preparar e outro para levá-la até às paredes em construção. “Antigamente chovia muito aqui e as casas só podiam ser construídas a partir de março – na primavera ainda chovia, mas menos e já dava para trabalhar, não é como agora que não cai uma pinga o ano todo”, acrescenta António. Esta equipa construía toda a casa, dos alicerces constituídos por um embasamento de rochas – existentes ou implantadas – até à cobertura.

Ouvindo António explicar de forma tão sucinta e simples o processo de construção destas casas, ocorrem-nos que erguer paredes de taipa era um pouco como construir um chão vertical com a mesma terra pisada e misturada com pedras que existia à volta da casa: estes homens faziam ao alto o trabalho que a natureza faz ao baixo, compactando a terra húmida à força de braços e da gravidade, que o tempo haveria de consolidar.

Chenelle também é Rodrigues, inquestionavelmente um antropónimo português (o conjunto dos nomes próprios, prenomes ou apelidos de família) e patronímico (nome com origem no nome pai ou de um ascendente masculino) que significava originalmente filha ou filho de Rodrigo. Chenelle Rodrigues não conhece a origem do seu apelido português, havendo duas hipóteses: um cruzamento efetivo e ancestral entre um colono português e uma mulher indiana, e cujo patronímico se perpetuou na família, ou uma apropriação

simples, igualmente ancestral, de um nome de origem portuguesa, algo que é relativamente frequente em Goa. O facto é que a fisionomia de Chenelle Rodrigues não deixa qualquer margem para dúvidas: os seus cabelos negros e lisos, com olhos grandes muito brancos e o tom moreno da sua pele correspondem a típica imagem que temos de uma mulher indiana, sem qualquer traço lusitano que pudéssemos, mesmo com imaginação, vislumbrar – não fosse a sua discreta timidez, e consequente pedido para não ser fotografada, e teríamos certamente uma boa imagem para documentar este facto.

À margem do tema da construção em taipa, e desta investigação cujas conclusões se espera venham a ser divulgadas em Portugal – “Quero fazer alguma coisa em Goa, sem qualquer dúvida, porque foi essa a minha inspiração, mas espero que o meu trabalho venha a ser útil também em Portugal, ficaria feliz” –, a verdade é que foi a curiosidade pelas distâncias, culturais, geográficas, que nos levaram até Chenelle, uma mulher indiana em viagem há cerca de dois anos: “Ando a viajar já há algum tempo. Já não penso duas vezes. Questiono aspetos de segurança, claro, tenho que o fazer, não ando à toa, é calculado”. E em relação à solidão, aos projetos de uma vida pessoal para quem está sempre em deslocação num extenso programa de realização profissional? “Muita gente me coloca essa questão”, responde-nos a sorrir. “E eu pergunto-me se não deveria realmente sentir-me só, e se pensar bem sim, talvez, mas eu não me descontraio muito, nunca paro – talvez devesse modificar isso, acho que gostaria de o fazer”.

E afinal as distâncias? No final deste périplo indo-alentejano pela construção em terra foi possível compreender um pouco da cultura alentejana, da complexa diversidade que caracteriza este imenso território? A resposta de Chenelle é de alguma forma surpreendente: “Acho que o Alentejo é muito parecido com Goa, e não é necessariamente por causa de um edifício, da arquitetura ou da paisagem, mas sobretudo a forma de ser das pessoas, não sei, os ambientes dos lugares: é sossegado, quer dizer, Goa tem mais vida que a maioria das pequenas cidades e vilas daqui – tem uma cultura indo-ocidental, é uma sociedade aberta; é alguma coisa no ar... sinto que estou em Goa, que não estou a viajar, estou em Goa. Quando saí de Goa e cheguei a Mourão, atravessando milhares de quilómetros, senti que estava de volta a Goa. E disse para mim própria: o que é que eu estou a fazer aqui...? Isso é especial, é excitante sentir-me em casa, é uma boa sensação e ao mesmo tempo aborrecida. Porque em certa medida aqui não estou a descobrir nada de verdadeiramente novo”.

a vertente da sustentabilidade. Não se trata aqui de promover a reconstrução de ruínas nem o projeto de novas construções, que implicam a utilização de meios que já não são artesanais, e consomem energia na utilização de meios mecânicos e poluentes, mas sim conservar e promover os edifícios existentes. “E nesse sentido, naturalmente, a taipa pode ser mais sustentável. Mas o objetivo principal é realmente compreender as influências portuguesas nas técnicas de construção local em Goa”, diz.

Depois de algumas passagens pelos distritos de Setúbal e Évora, sempre desbravando montes, vilas e aldeias, no distrito de Beja Chenelle caminhou anteriormente por Moura e Safara. Naturalmente adaptada ao calor, afirma que passou um mau bocado quando em julho as temperaturas chegaram perto dos 50 graus. “Era demais”, afirma.

O “Diário do Alentejo” acompanhou o seu último dia de trabalho no terreno, entre Serpa e Vales Mortos. Faltavam-lhe visitar quatro casas e tentar falar com os respetivos proprietários, inquilinos ou alguém envolvido na construção. E as casas efetivamente lá estavam, bem referenciadas no livro que transporta permanentemente debaixo do braço e que só pousa sobre a terra para tirar

fotografias: uma ruína; um monte relativamente intacto mas abandonado; uma casa de férias reabilitada e aumentada com alvenaria; e uma outra devoluta, à venda, inacessível com um portão fechado a cadeado, que aparenta estar reabilitada, mas com uma ruína ao lado pelo que é difícil de perceber à distância, e no meio de arvoredo, como realmente evoluiu essa propriedade. Pessoas é que não. Ninguém.

Graças a Maria Silvestre, a

“A TERRA DEVE SER TRANSPORTADA POR UM COXO E BATIDA POR UM LOUCO”

Diz o ditado português, porque na construção em taipa a compactação deve ser um processo demorado e forte. É desconhecida a origem da construção em terra. Tipicamente mediterrânica, de climas secos, em Portugal resultará de influências islâmicas e técnicas autóctones. Recurso natural, a terra é o mais abundante e mais antigo material de construção. Jericó, Cisjordânia, nas margens do rio Jordão, é considerada a mais antiga cidade existente. O complexo edificado atual tem cerca de sete mil anos, embora o assentamento mais antigo identificado tenha cerca de 11 mil anos, onde se podem identificar duas técnicas de construção distintas: terra compactada e adobe (pequenos tijolos de terra compactada), ambas rebocadas com argamassa de lama. Conhecida por

ser termicamente equilibrada, relativamente ao calor do verão e ao frio do inverno, a construção em taipa tradicional era indissociável dos rebocos à base de cal e areia, interiores e exteriores: a vulnerabilidade da terra são as infiltrações de água, quer pelo topo das paredes, quer pelas juntas entre fiadas sobre as quais se aplicavam “fitas” de reboco para as selar. A construção em taipa atual é simultaneamente uma moda de contornos estéticos, em que se procura deixar a terra à vista sem reboco, ou uma técnica reabilitada pelas suas qualidades intrínsecas. Da metodologia artesanal terá já pouco, e ficando a terra à vista, como se procura fazer também com os tijolos das abóbadas interiores de edifícios antigos, obriga à utilização de impermeabilizadores industriais.

dezembro 18, 2018

Goa and Portugal – links and living heritage

Chenelle Rodrigues

Earthen houses of Goa (India) and Alentejo (Portugal): Comparison of Local Building Cultures and Conservation Approaches

The research is part of Chennelle post-master's DSA-Earthen Architecture and Heritage programme at CRAterre Laboratory, the International Centre for Earthen Architecture at the École Nationale Supérieure d'Architecture de Grenoble – France.

Alentejo and Goa share a common architectural heritage, that which appears to be houses built in layers of mud. How were these houses built? Was there an exchange of mud-building techniques during the 450 years of Portuguese reign in Goa? During her two-month stay in Portugal funded by the Fundação Oriente, Chenelle describes her experiences with Portuguese architecture and culture, and their resemblances to Goa...



Photo credits: Rui Cambraia

In retrospect, I might have been too ambitious, a tad overenthusiastic, and maybe, a tiny bit reckless – I could not speak Portuguese, did not drive a car, and yet decided to make base in a tiny village called Mourão along the Eastern border of Portugal while researching the ‘Earthen Houses of Alentejo’. Though much of Mourão’s population belongs to the senior age group, who had information valuable to my research, only a few could speak English or French (languages I speak). Public transport too was limited to a couple of buses a day. And yet, I managed to work on my research. How?

The people were helpful, kind and curious about my research topic. Architect Mariana Correia permitted me to expand on the case-studies included in her study, *Rammed Earth in Alentejo* (2000), which facilitated my research. Residents offered to drive me in their cars to locate earthen-houses across the villages of Alentejo, and even to translate from Portuguese to English or French as I gathered information from house owners and others. Even more, they opened their doors and welcomed me into their homes. I was also fortunate to have had the opportunity to attend local events, and spend my time in Mourão, around the quaint and beautiful Lake Alqueva, one of Europe’s largest artificial lakes.

My journey got more exciting by the day as I went about my research, visiting Lisbon and finding my way through the various Alentejano villages, listening to inhabitants speak of their childhood memories of building with mud, the yearly activity of whitewashing walls of houses just before the village feast, so that everything would look bright and new when the religious procession passed by their homes, etc. It was interesting to note that many inhabitants in villages and cities alike, had origins or remote ancestral connections with Mozambique, Angola

and other past Portuguese colonies, thus comprising a Portuguese population that is multi-ethnic and naturally integrated amongst themselves. For me, it was especially touching to meet people with connections to my home-state, Goa: people of Goan origin who related stories about their or their parents' childhood in Goa, others who served in the army during the Portuguese period in my home state, and those who visited on holiday or research. They spoke about Goa with a sense of affiliation, nostalgia and fondness. There's a strong resemblance between Goa and Portugal, at least the region that I was based in. It may not necessarily be in terms of the architecture or festivities, but more so, in the attitudes and way of life of the people, and the ambience their presence creates – a realisation that set in after weeks of living there.

It was a successful two months of study and social integration. There are many people in Portugal that I am thankful to as I continue this research on the earthen houses of Goa and Alentejo. The research trip not only brought to light many close links between the mud-houses of Goa and Portugal, but also between us, as people with a shared culture.”



Photo credits: Rui Cambraia



Por [Rede de Bolseiros](#)

[Alentejo](#)

[Atividades bolseiros](#)

[bolsas de curta duração](#)

[Experiências](#)

Table of images

Image 1 and Image 2 : Les maisons au Portugal.

Image 3 and Image 4 : Les maisons à Goa.

Image 5 : Mur en terre à Goa.

Image 6 : Mur en terre en Alentejo.

Image 7 : Carte des colonies portugaises.

Image 8 : Vieilles et nouvelles conquêtes, Goa.

Image 9 : Map of Portuguese colonies.

Image 10 : Old and New Conquests, Goa.

Image 11 : Location of Goa in India.

Image 12 : Physiographic divisions of Goa.

Image 13 : Goa is divided into two districts (North Goa and South Goa), which are further subdivided into 12 'talukas'.

Image 14 : Geological map of Goa.

Image 15 : A schematic section of a typical laterite profile.

Image 16 : Soil map of Goa.

Image 17 : Seismic intensity map of India.

Image 18 : Inside a Goan club ('kudd'), Mumbai.

Image 19 : Karachi Goan Association, Pakistan.

Image 20 : Goan Soccer League logo, Canada.

Image 21 : World Goa Day, USA.

Image 22 : World Goa Day, Australia.

Image 23 : World Goa Day, Qatar.

Image 24 : St. Thomas Chapel, Panaji, North Goa.

Image 25 and Image 26 : Date of construction engraved on the truss of a house. Colva, Salcete, South Goa, 2014.

Image 27 : 'Tulsi vrindavan' built with earth.

Image 28 : 'Cross'.

Image 29 : Mud-and-wood or Wattle-and-daub constructions in Goa.

Image 30 : Preparation of the cob mix.

Image 31, Image 32 and Image 33 : Cob construction process in Goa.

Image 34 : Adobe construction process in Goa.

Image 35 and Image 36 : Composition of a composite wall.

Image 37, Image 38, Image 39, Image 40, Image 41 and Image 42 : Construction process, composite walls in Goa.

Image 43, Image 44 and Image 45 : Mounting of the rammed-earth form-work.

Image 46 : Rammed-earth construction process.

Image 47 : Arvalem, Bicholim, North Goa.

Image 48 : North Goa, 2015.

Image 49 : Earthen mortars in laterite masonry.

Image 50 : Earthen plasters. Bardez, North Goa, 2015.

Image 51 : Compound wall. Comba, Margao, South Goa.

Image 52 : Fences in agricultural fields. Ponda, South Goa.

Image 53 : Water retaining walls in agricultural fields. Aldona, Bardez, North Goa, 2015.

Image 54 : Water retaining walls in salt pans.

Image 55, Image 56 and Image 57 : Corbelling made with 'Country-tiles'.

Image 58 and Image 59 : The 'padvi' or 'pakadi' i.e. the lean-to with masonry seats, along the facades of rural Goan houses eventually evolved into a veranda with decorative railings and colonnades under the Portuguese influence, and took the form of a 'balkâmv' or 'balcão'.

Image 60 : The 'balkâmv' or 'balcão' of the Indo-Portuguese house. Margao, Salcete, South Goa, 2012.

Image 61 : Archbishop's Palace. Altinho, Panaji, North Goa.

Image 62 : Silva house. Margao, South Goa.

Image 63 : Location of Salcete 'taluka', South Goa district.

Image 64 : Sanguem 'talkuka', South Goa.

Image 65 : Pernem 'taluka', North Goa.

Image 66 : Location of buildings surveyed in Goa.

Image 67 : 'Lift' joints visible (Survey no. 6).

Image 68 : 'Lift' joints not visible; the wall displays a uniform finish (Survey no. 9).

Image 69 : Generally, top soil tends to be more sandy with more rubble.

Image 70 : Holes along the horizontal 'lift' joints, which perhaps indicates the use of form-work in cob construction (Survey no. 11).

Image 71 : Corners; a laterite-stone sits above the earthen base-course (Survey no. 1).

Image 72 : Corners; laterite-and-earth masonry (Survey no. 3a).

Image 73 : Corners; earth with laterite-stones at intervals (Survey no. 11).
Image 74 : Corners; laterite-and-cement pillars; not original to the structure (Survey no. 4).
Image 75 : Rammed-earth 'lifts' could not be determined as the walls displayed an uniform texture. The walls
Image 76 : Corners; lower walls in laterite masonry, upper walls in earth.
Image 77 and Image 78 : Mason Babuso's adobe-brick mould.
Image 79 : Evidence of laterite masonry base-course (Survey no. 14).
Image 80 : Yellowish soil; includes clay, sand, and rubble (Survey no. 4).
Image 81 : Red, lateritic soil with lots of rubble (Survey no. 6).
Image 82 : Yellow-brown-red soil, more clayey than sandy (Survey no. 13).
Image 83 : Cob (Survey no. 2).
Image 84: Adobe-bricks (Survey no. 4).
Image 85: Rammed-earth (Survey no. 13).
Image 86 : Almost all the structures visited for this study had verandas, porches and/or 'sopos'.
Image 87 : A small, earthen gradient covered the foot of external walls (Survey no. 12).
Image 88 : Sometimes, laterite-stones fringe the gradient (Survey no. 1).
Image 89 : Setback along the base-course (Survey no. 14).
Image 90 : Front facade window of the hall (Survey no. 3a).
Image 91: Rear, service area window (Survey no. 11).
Image 92 : Lintels of doors and windows were mostly slanted, and opened up to the interior of the house (Survey no. 3a).
Image 93 : In a few cases, the lintels were simply placed horizontally (Survey no. 12).
Image 94, Image 95 and Image 96 : The wooden shutters constitute a protruded extension in the inner corners, which served as hinges. These elongated corners were loosely fitted into holes made in the lintel. This provision facilitated the opening and closing the shutters. (Survey no. 7).
Image 97 : Evidence of holes in the lintels suggests that that the old-styled hinged windows once existed (Survey no. 6).
Image 98 : Vents along wall tops (Survey no. 3a).
Image 99: Section of a vent (Survey no. 11).
Image 100 : Earthen pillar (Survey no. 8).
Image 101 : Provisions for niches and shelves in walls were made at the time of construction (Survey no. 15).
Image 102 and Image 103 : Laterite masonry niches in earthen walls (Survey no. 9).
Image 104 : Room dividers made with woven mats (Survey nos. 4, 6).
Image 105 : Loft for storing agricultural materials such as ladders — not for grains (Survey no. 12).
Image 106 : Kitchen loft (Survey no. 13).
Image 107 and Image 108: A flap opened in the roof, creating an opening (Survey no. 7).
Image 109 : The upper part of the roof thrusts upwards, and is separate from the lower part (Survey no. 12).
Image 110 : Wall heights were extended using laterite-stones (Survey no. 7).
Image 111 : Sometimes, the raised part was plastered and painted like the rest of the wall.
Image 112 and Image 113 : On some wall tops, laterite-stones were placed at random intervals.
Image 114 : Sometimes, the wooden plate directly rested on the top of the wall, and held the framework.
Image 115 : The ridge of the roof framework was made from the trunk of the coconut tree.
Image 116 : Bamboo batons were used in case of 'Country-tile' roofs.
Image 117 : Sometimes, bamboo and other similar materials were used
Image 118 : Sample of a ventilating roof-tile.
Image 119 : Glass tiles inserted in the roof to bring in natural light (Survey no. 3a).
Image 120 : Metal-sheet overhangs (Survey no. 9).
Image 121 : Wooden pegs along the lengths of some façade walls (Survey no. 15).
Image 122 : In Survey no. 8, make shift hooks were observed.
Image 123 : Two decoratively cut laterite-stones that juttred-out from the wall top
Image 124 and Image 125 : (Survey no. 8).
Image 126 : (Survey no. 3a).
Image 127 : Two, instead of one baton was fixed along the ends of the roof's framework (Survey no. 13).
Image 128 : Splits of the beetle-nut tree were used as batons. Two batons were used along the roof-line. (Survey no. 12).
Image 129 and Image 130 : Small, wooden batons were fixed on roof corners (Survey nos. 11, 13).
Image 131 : Eaves (Survey no. 15).
Image 132 : Palm-leaf extension at the rear of the house (Survey no. 9).
Image 133 : Palm-leaf barriers poised parallel to earthen walls protected the walls from rainwater (Survey no. 1).
Image 134 : Mortars were present in those parts of the walls that had laterite-stone masonry
Image 135 : Earthen mortars with lime re-pointing (Survey no. 3a).
Image 136 : This was observed on exterior walls, especially on front facades (Survey no. 7).
Image 137 : In some cases, it was observed on interior walls as well (Survey nos. 3a, 14).
Image 138 : The lack of support provided by rotting lintels caused the roof to put pressure on the wall,
Image 139 : Old abraded stick-brooms used when the roof in Survey no. 7 was repaired in 2018.

Image 140 : An owner demonstrating how to manually break earthen-nests built by insects on interior walls (Survey no. 4).

Image 141 and Image 142: House renovated on before wedding celebrations.

Image 143 : Map of Portugal and location of Alentejo.

Image 144 : Geological map of Portugal.

Image 145 : Soil map of Portugal.

Image 146 : Macro seismic intensity in Portugal.

Image 147 : Map showing the main traditional earth building techniques in Portugal.

Image 148 and Image 149: Rammed-earth fortification walls. Castelo de Mourão, Évora, Alentejo, 2018.

Image 150 and Image 151: Rammed-earth compound wall. Beja, Alentejo, 2018.

Image 152 : The traditional blue colour was later over-painted by reddish-pink shade. Beja, Alentejo, 2018.

Image 153 : Painting base-courses and the frames of openings in traditional colours continues even today.

Image 154, Image 155, Image 156, Image 157, Image 158 and Image 159 : Different types of vaults and cupolas.

Image 160 : An oven built at one end of the house. Serpa, Beja, Alentejo, 2018.

Image 161 and Image 162 : An oven built away from the house. Serpa, Beja, Alentejo, 2018.

Image 163 and Image 164 : A schist quarry. Near Mourão, Évora, Alentejo, 2018.

Image 165 : Location of Alentejo in Portugal.

Image 166 : Location of Évora district in Alentejo.

Image 167: Beja district in Alentejo.

Image 168: Setúbal district in Alentejo (and Lisbon).

Image 169 : Location of buildings surveyed in Alentejo.

Image 170 : Simple typology i.e. walls without mortar or other materials (Survey no. 1[1]).

Image 171 : 'Lifts' separated by a layer of mortar + fired-bricks (Survey no. 2[38]).

Image 172 : Two rammed-earth layers within each block, separated by a layer of mortar + fired-brick + mortar (Survey no. 3[9]).

Image 173 : Old village, 'Aldeia da Luz'.

Image 174 : Old village, 'Aldeia da Luz'.

Image 175 and Image 176 : New village, 'Luz', 2018.

Image 177 and Image 178 : In Safara, even the big houses that belonged to landowners were in rammed-earth.

Image 179 : Builder of 'Monte dos Sobreiros' (Survey no. 12[27]),

Image 180 : Rammed-earth 'lifts' separated by earth and lime mortar (Survey no. 11[25]).

Image 181 : Vx i.e. Red or yellow Mediterranean soils, with schist (Survey no. 11[25]).

Image 182 : Pmg i.e. Grey Mediterranean soils, with quartzitic diorites (Survey no. 2[38]).

Image 183 : Pac+Vcm i.e. Grey Mediterranean soils, marly limestone or marls + Red or yellow Mediterranean soils (Survey no. 3[9]).

Image 184 : Sr i.e. Red or yellow Mediterranean soils, clayey with deposits (Survey no. 10[19]).

Image 185 : Px i.e. Grey Mediterranean soils, with schist or greywackes (Survey nos. 6[14]).

Image 186 : Ex i.e. Githosoils, with schist or greywackes) (Survey no. 8[40] — second rammed-earth layer).

Image 187 : External walls in rammed-earth and internal walls in adobe-bricks (Survey no. 1[1]).

Image 188 : L-shaped element at the corners, inside the rammed-earth walls.

Image 189 : Fired-brick overhangs.

Image 190 : Blue highlights along the external wall-bases, 2018 (Survey no. 10[19]).

Image 191 : Blue highlights along door and window frames, 2018 (Survey no. 12[27]).

Image 192 : Coloured and white interior walls seen in the ruins of an earth building. Mourão, Évora, 2018.

Image 193 : Wall in Moura, Beja, 2018.

Image 194 : A ruin of a house in Serpa, Beja, 2018.

Image 195 : Today, many white wash their walls with paints ('tinta' in Portuguese). Mourão, Évora, 2018.

Bibliography

Publications

- Achenza, Maddalena, Mariana Correia, Marco Cadinu, and Amadeo Serra, eds. *Houses and Cities Built With Earth: Conservation, Significance and Urban Quality*. Lisbon: Argumentum, 2006.
- *Arquitetura Popular em Portugal Alentejo 3º Vol.* Associação dos Arquitectos Portugueses, 1988.
- Associação Centro da Terra. *Arquitetura de Terra em Portugal. Earth Architecture in Portugal*. Lisbon: Argumentum, 2005.
- Barros Pereira, Akeru and Gerard da Cunha, ed. *The Indo-Portuguese House*. Porvorim: Architecture Autonomous, 2013.
- Borges, Charles J., and Helmut Feldmann. *Goa and Portugal: Their Cultural Links*. New Delhi: Concept Publishing Company, 1997.
- Caetano, Paulo and Rui Vasco. *Terra Crua Arquitetura de Natureza*. Bizâncio, 2011.
- Correia, Mariana, Gilberto Carlos, and Sandra Rocha. *Vernacular Heritage and Earthen Architecture: Contributions For Sustainable Development*. London: Taylor & Francis Group, 2014.
- Correia, Mariana. *Rammed Earth in Alentejo*. Lisbon: Argumentum, 2007.
- Costa Silveira, Angelo. *Lived Heritage, Shared Space: The Courtyard House of Goa*. New Delhi: Yoda Press, 2008.
- De Bragança Pereira, A. B. *Ethnography of Goa, Daman and Diu*. New Delhi: Penguin Books India Pvt Ltd, 2008.
- Dessai, Ashoka G. *Geology and Mineral Resources of Goa*. New Delhi: New Delhi Publishers, 2018.
- Fernandes, Pantaleão. *Traditional Occupations of Goa*. Benaulim: The Word Publications, 2015.
- Fjeld, Ivar. *The Jewish Martyrs of Old Goa*, 2014
- Gomes, Prof. Dr. Olivinho J. F. *A Concise History of Goa*. Panaji: Directorate of Official Language, Government of Goa, 2010.
- Gune, Dr. V. T., ed. *Gazetteer of the Union Territory Goa, Daman and Diu*. Panaji: Gazetteer Department, Government of the Union Territory of Goa, Daman and Diu, 1979.
- Issar, T. P. *Goa Dourada: The Indo-Portuguese Bouquet*. Bangalore: T P Issar, 1998.
- Khedekar, Vinayak Vishnu. *Goa: Land, Life and Legacy*. Panaji: Directorate of Art & Culture, Government of Goa, 2016.
- Khullar, D. R. *India: A Comprehensive Geography*. Ludhiana: Kalyani Publishers, 1999.
- Mascarenhas, Antonio and Glenn Kalavampara. *Natural Resources of Goa: A Geological Perspective*. Goa: Geological Society of Goa, 2009.
- Nadri, Ghulam A. *The Political Economy of Indigo in India, 1580-1930: A Global Perspective*. Boston: Brill, 2016.
- Pandit, Heta and Annabel Mascarenhas. *Houses of Goa*. Porvorim: Architecture Autonomous, 1999.
- Pandit, Heta and Farah Vakil. *Hidden Hands: Master Builders of Goa*. Porvorim: Heritage Network, 2003.
- Rangel-Ribeiro, Victor, ed. *Goa Aparanta – Land Beyond the End*. Vasca da Gama: Goa Publications Private Limited, 2008.
- Saxena, H. M. *India and World Geography*. Jaipur: Rawat Publications, 2016.
- Soeiro de Brito, Raquel. *Goa E as Praças Do Norte*. Lisbon: Junta de Investigações do Ultramar, 1966.
- Soeiro de Brito, Raquel. *Goa e as Praças do Norte*. Lisbon: Junta de Investigações do Ultramar, 1966.
- Tirtha, Ranjit. *Geography of India Second Edition*. Jaipur: Rawat Publications, 2002.
- Tumble, Chinmay. *India Moving: A History of Migration*. Penguin India, 2018.

Handbooks, reports and other studies

- Chandramouli, Dr. C. Indian Administrative Services, Office of the Registrar General & Census Commissioner, Ministry of Home Affairs, Government of India, *Census of India 2011 Administrative Atlas of India*, New Delhi: S. Narayan & Sons.
- Chinmay Tumble. *Remittances in India: Facts & Issues*. Bangalore: Indian Institute of Management, 2011.
- Correia, Mariana. *Le Pise d'Alentejo, Portugal*. DPEA-Terre dissertation, CRAterre-ENSAG, 2000.
- Directorate of Planning, Statistics & Evaluation, Government of Goa. *Goa Economy in Figures – 2017*.
- Fernandes, Noah. *The Rational of Primitive Shelter Case: Goa*. Bachelor of Architecture dissertation, Goa College of Architecture, 2012.
- ICAR-NBSS & LUP Technologies. *LRI Technology - A Base for Sustainable Agriculture*. e-Publication.
- Instituto Dom Luiz. *Chapter 2. 20th Century Portuguese Climate and Climate Scenarios*. http://idl.campus.ciencias.ulisboa.pt/wp-content/uploads/2016/11/Siam1_Clima_0.pdf (accessed August 22, 2019).
- José dos Santos Parreira, Daniel. *Análise Sísmica de uma Construção em Taipa*. Master of Civil Engineering dissertation, Instituto Superior Técnico, Universidade Técnica de Lisboa, 2007.
- Kambli, Tushar. *A Comparative Study of Settlement Pattern and House Form in the Neighbouring Villages of Chorla and Surla*. Bachelor of Architecture dissertation, Goa College of Architecture.

- Kanchi, Madhulika. *Earth — As A Building Material: A case of Goa*. Bachelor of Architecture dissertation, Goa College of Architecture, 2017.
- Lobo, Atanasio. "FREE GOA from INDIAN Invasion & it's Continued Illegal Occupation against UN Resolution." https://www.change.org/p/prevent-genocide-of-goan-christians-by-communal-corrupt-illegal-indian-administrati-on-in-go-a-former-portuguese-colony-where-goans-are-forced-to-immigrate-from-their-own-motherland-to-other-countries?use_react=false
- Lobo, Larissa. *Earth in Architecture*. Bachelor of Architecture dissertation, Goa College of Architecture, 2006.
- Mahajan G. R., Bappa Das, B. L. Manjunath Viswanatha Reddy K., S. Manivannan, R. R. Verma, and N. P. Singh. *Weather trends of Last Fourteen Years (2002 – 2015) at ICAR – Central Coastal Agricultural Research Institute, Old Goa*. Technical Bulletin No 61. Old Goa: ICAR-Central Coastal Agricultural Research Institute, 2016.
- Maria da Conceição Lopes Aleixo Fernandes. *A Cultura Construtiva do Adobe Em Portugal*. Universidade de Coimbra, 2013.
- Menezes Gama, Lira. *Migration from Goa: Factors, Household, Characteristics and Consumption Expenditure Inequalities*. Goa University, 2017.
- Ministry of Statistics and Programme Implementation, Government of India (Source: Directorate of Economics & Statistics of respective State Governments). *Statewise Domestic Product (Provisional)*, 2018.
- Munj, Poonam. *Colour in Architecture – Perception of Colour in Spatial Environment in Context of Goa*. Bachelor of Architecture dissertation, Goa College of Architecture, 2005.
- National Bureau of Soil Survey & Land Use Planning, Indian Council of Agricultural Research. *Soils of Goa for Optimising Land Use b. Executive Summary*. Nagpur, 1999.
- National Bureau of Soil Survey & Land Use Planning, Indian Council of Agricultural Research. *Soil Series of Goa*. Nagpur, 2002.
- *O Regresso À Terra: Redescobrimo E Reinventando Safara*. ADCMoura, 2008.
- Parc Naturel Régional des Marais du Contenin et du Bessin. *Restaurer son Bâti en Terre*. Normandy: PNR des Marais du Contenin et du Bessin, 2010.
- Rodrigues, Chenelle Fatima. *Regional Distinctiveness of Earthen Structures: Construction Techniques and Conservation Approaches. A Comparison of Mudwall/Cob Buildings in Perthshire – Scotland and Normandy – France*. MSc Architectural Conservation dissertation, University of Edinburgh, 2015.
- Saraiva Pereira, Catarina. *Savoir-faire, Enseignement et Construction en Pisé Dans Le Bas Alentejo*. CEAA-Terre dissertation, CRAterre-ENSAG, 2014.

Newspaper and newsletter articles

- "Goa essence displayed at World Goa Day." www.thepeninsulaqatar.com, November 23, 2017, <https://thepeninsulaqatar.com/article/23/11/2017/Goan-essence-displayed-at-World-Goa-Day>
- Goa Foundation. "Goa mining ban: The truth that lies beneath." *The Economic Times* (India), April 10, 2018, <https://economictimes.indiatimes.com/blogs/et-commentary/goa-mining-ban-the-truth-that-lies-beneath/>
- Karachi Goan Association. "Flashback: From Goa with love." www.dawn.com, September 16, 2012, <https://www.dawn.com/news/749685>
- Madhavi Sardesai, "Mother Tongue Blues." <http://www.india-seminar.com/2004/543/543%20madhavi%20sardesai.htm> (accessed June 4, 2019)
- Menezes, Vivek. "'Portuguese architecture' in Goa has little to do with the Portuguese and everything to do with Goa." *Scroll.in*, November 13, 2017, <https://scroll.in/magazine/856585/portuguese-architecture-in-go-a-has-little-to-do-with-the-portuguese-and-ever-thing-to-do-with-go-a>
- Merchant, Shripad S. "Tenant cannot become mundkar: HC." *The Times of India*, November 27, 2012, <https://timesofindia.indiatimes.com/city/goa/Tenant-cannot-become-mundkar-HC/articleshow/17395060.cms>
- NT Network. "Disaster management meet today to assess damage." *The Navhind Times*, December 5, 2017, <http://navhindtimes.in/disaster-management-meet-today-to-assess-damage/>
- Pratap Singh, Narendra. "From Editor's Desk..." *Newsletter, ICAR Research Complex for Goa, Indian Council of Agricultural Research*, May to August, 2014, Volume 16, Number 2.
- PTI. "Heavy rains cause flooding in Goa, several evacuated." *The Hindu*, August 6, 2019, <https://www.thehindu.com/news/national/other-states/heavy-rains-cause-flooding-in-go-a-villages-several-evacuated/article28830981.ece>
- Sen, Arijit. "The kudd life: Mumbai's mini Majordas, Calangutes." www.hindustantimes.com, March 24, 2016, <https://www.hindustantimes.com/lifestyle/goan-join-the-club/story-eE61ZCev4N8UxbHxRbWZO.html>

Online publications

- Borges, Charles J., Óscar G Pereira, and Hannes Stubbe, eds., *Goa and Portugal: History and Development*. New Delhi: Concept Publishing Company, 2000.
- Brockey, Liam Matthew. *Portuguese Colonial Cities in the Early Modern World*. Surrey: Ashgate Publishing Limited; Burlington: Ashgate Publishing Company, 2008.

- Carter, H. Adams. "Classification of the Himalayas." In *The American Alpine Journal*. New York: The American Alpine Club, 1985.
- Juang, Richard M. and Noelle Morrissette. *Africa and the Americas: Culture, Politics, and History Volume 1*. Santa Barbara: ABC-CLIO, 2008.
- Mukerji, Sarita Kumar. *Islands of India*. New Delhi: Ministry of Information and Broadcasting Government of India, 1992.
- Page, Melvin Eugene. *Colonialism: An international Social, Cultural and Political Encyclopedia*. Santa Barbara: ABC-CLIO, 2003.
- Phillips Jr., William D. and Carla Rahn Phillips. *A Concise History of Spain*. New York: Cambridge University Press, 2010.

Websites

- "House of Seven Gables / Sat Burzam Ghor." <https://www.trawell.in/goa/panjim/house-of-seven-gables-sat-burzam-ghor>
- Amateur Seismic Centre. "Earthquakes in Karnataka & Goa, India." <http://asc-india.org/seismi/seis-karnataka-goa.htm>
- Amateur Seismic Centre. "Karnataka & Goa, India." <http://asc-india.org/maps/hazard/haz-karnataka-goa.htm>
- Census 2011 India: www.census2011.co.in
- Deshpande Abhijeet. "Archbishop's Palace." <https://timesofindia.indiatimes.com/travel/destinations/Archbishops-Palace/ps52499616.cms>
- Directorate of Planning, Statistics & Evaluation, Government of Goa: www.goadpse.gov.in
- Escola Superior Gallaecia. "Portuguese Historical Seismicity." <https://esg.pt/seismic-v/portuguese-historical-seismicity/>
- European Commission. *Alentejo Region of Portugal*. <https://ec.europa.eu/growth/tools-databases/regional-innovation-monitor/base-profile/alentejo-region-portugal>
- Goa District and Taluka Maps: <http://vlist.in/map/30.html>
- Goan Soccer League Toronto: www.goansoccer.com
- Government of Goa official portal: www.goa.gov.in
- Houses of Goa museum: www.archgoa.org
- India Brand Equity Foundation: www.ibef.org
- Maps on the web: www.mapsontheweb.zoom-maps.com
- Ministry of Earth Sciences, Government of India. "Earthquake Prone States." https://www.moes.gov.in/writereaddata/files/LS_US_1780_26072017.pdf
- Ministry of Statistics and Programme Implementation, Government of India: www.mospi.gov.in
- National Institute of Disaster Management, Government of India. "Seismic Zoning." https://nidm.gov.in/safety_earthquake.asp
- National Institute of Disaster Management, Government of India. "Designing Safe House in an Earthquake Prone Area." https://nidm.gov.in/safety_earthquake.asp
- National Portal of India: www.archive.india.gov.in, www.india.gov.in
- National Portal of India: www.india.gov.in
- O Alentejo. "Carte de l'Alentejo." Alentejo: <https://www.visitalentejo.pt/fr/alentejo/carte-de-l-alentejo/connait>
- O Laboratório Nacional de Energia e Geologia (LNEG). "Portugal - Exploration and Mining (2000)." https://www.lneg.pt/CienciaParaTodos/edicoes_online/diversos/portugal_geology/texto
- Office of the Registrar General & Census Commissioner, Ministry of Home Affairs, Government of India: www.censusindia.gov.in
- Portal for climate change in Portugal: <http://portaldoclima.pt/en/project/summary/>
- Portuguese Institute for Sea and Atmosphere: <https://www.ipma.pt>
- U. S. Geological Survey (USGS) Earthquake Hazards Program. "Magnitude / Intensity Comparison." https://earthquake.usgs.gov/learn/topics/mag_vs_int.php
- U. S. Geological Survey (USGS) Earthquake Hazards Program. "The Modified Mercalli Intensity Scale." <https://earthquake.usgs.gov/learn/topics/mercalli.php>
- UNESCO World Heritage Centre: www.whc.unesco.org
- www.missiongreengoa.blogspot.com
(https://1.bp.blogspot.com/-pATGGueZQ4k/XLYX-NtU2HI/AAAAAAACt40/EmNdw8d9ojg_qMJW9UvbazDO0QN8UKUrQCLcBGAs/s1600/IMG-20190416-WA0029.jpg)

.....