



HAL
open science

Can modular-vernacular architecture be a viable alternative for social housing in Mauritius?

Khushboorani Beekawoo

► **To cite this version:**

Khushboorani Beekawoo. Can modular-vernacular architecture be a viable alternative for social housing in Mauritius?. Architecture, space management. 2021. dumas-03489468

HAL Id: dumas-03489468

<https://dumas.ccsd.cnrs.fr/dumas-03489468v1>

Submitted on 17 Dec 2021

HAL is a multi-disciplinary open access archive for the deposit and dissemination of scientific research documents, whether they are published or not. The documents may come from teaching and research institutions in France or abroad, or from public or private research centers.

L'archive ouverte pluridisciplinaire **HAL**, est destinée au dépôt et à la diffusion de documents scientifiques de niveau recherche, publiés ou non, émanant des établissements d'enseignement et de recherche français ou étrangers, des laboratoires publics ou privés.



Distributed under a Creative Commons Attribution - NonCommercial - NoDerivatives 4.0 International License

Can modular - vernacular architecture be a viable alternative for social housing in Mauritius?



→ nantes
ensa
→ architecture

→ nantes
ensa
→ architecture
[mauritius]

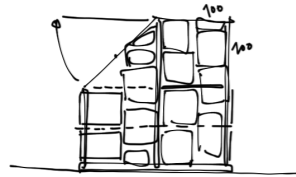

Khushboorani Beekawoo

Can modular-vernacular architecture be a viable alternative for social housing in mauritius?

Ecole Nationale Supérieure d'Architecture de Nantes

Masters Thesis 2021

Seminar « Récits Digitaux »

Under the supervision of:

Dr. Laurent LESCOP

Acknowledgement

This work is dedicated to my loving family and sister, without whom this venture would not have come to fruition.

My most sincere thanks go to my supervisor, Laurent Lescop, who closely followed my progress, and my mentor, Dharam Dev Bunjun, who guided me at different stages of the study towards a realistic architecture for our small island Mauritius.

I would also like to express my gratitude to all my lecturers including Anetta, Marta and Fatima; to all my classmates including Irshaad, Anaïs, Navneesh, Yash, Shaneel, Striven, Muntazir, Nicolas, Divakar, Gianish, Romesh, Darëll, Taaseen, and Niren; to my cousin Kavita; and to my friends Trinesha and Nidhi for their invaluable support and suggestions and for being a source of motivation.

A special thanks also to all interviewees, survey participants and everyone who directly and indirectly helped me in gathering data and advice, making this research work a beautiful exploration.

ECOLE NATIONALE SUPERIEURE D'ARCHITECTURE DE NANTES
DOCUMENT SOUMIS AU DROIT D'AUTEUR

“Even if a building is made of paper—if people love it, this building, it can become permanent. The church I built out of paper in Kobe in 1995—after the earthquake there—was meant to be for three years, but it was there for eleven years. This paper church has become a permanent church in Taiwan.”

Shigeru Ban

Abstract

KEYWORDS

social housing | modular | vernacular | participative | low-cost housing | mauritian architecture
integrated design | self-build

In Mauritius, unfortunately, many people do not own a proper house and live in poor conditions. With natural disasters getting more frequent, these families are constantly in danger. But even with numerous Social Housing campaigns, both the public and private actors in the sector are facing difficulties to provide a concrete house to each family in need. This is because construction costs keep on increasing each year together with the demand and debt from rent backlog burdening the sector.

This research has thus been conducted with an aim to proposing a new affordable and eco-friendly construction method for social housing, adapted to the local context, while also hinting towards global housing crisis.

Through literature review, actual local construction methods and new modular ones in the international context were studied. These were compared to locally-available materials and their corresponding prices in an Atlas.

A SWOT Analysis helped to identify which threats to focus on: climatic risk, public reluctance; and acknowledge the requirements: minimum investments, experts' intervention.

Interviews were done to collect qualitative and quantitative data. Finally, a survey helped to complement previous information and verify public opinion.

Based on the analysis, a layout was designed on AutoCAD and two modular construction methods were proposed, namely a bamboo structure and wood structure; with three finish material options: earth, bamboo and thatch.

An in-depth analysis was done through construction detailing, physical scale models to test the assembling techniques and cost estimations.

The proposals were evaluated to be good alternatives to concrete, but still require experiments to prove their cyclonic resistance. Also, minimum investment for foundation, labor, and transport are needed. Natural material also needs maintenance to prevent water damage, insect invasion, etc.

Contents

Introduction	11						
Problem Statement							
Structure and Methodology							
Aim							
Objectives							
Limitations							
		Background Study and Literature Review		Analysis and Design Proposal		Discussion and Evaluation	
		A. Social housing in Mauritius		A. Analysis		Critique of the project	
		1. A history with climate	16	1. SWOT analysis	58	1. Is the project viable?	90
		2. Issues in social housing	17	2. Interviews	60	a. Cost	
		a. Cost factor		3. Survey	62	b. Public acceptance	
		b. Time		4. Atlas of Materials	66	c. Local climate	
		c. Ecology				d. Constructability	
		d. Culture		B. Design Proposal		e. Local resources	
		3. Positive aspects of social housing	22	1. Mind map	70	f. Durability and maintenance	
		4. Recommendations from researchers	22	2. The final layout	71		
		B. Architectural Movement in Housing Sector		3. The modules	73	2. How far have the social housing issues been tackled?	92
		1. Modular Architecture	24	4. The structure	74	a. Cost factor: Integrative approach	
		a. Definition of modular architecture		Structure proposals		b. Time factor: Modular approach	
		b. Types of modular architecture		1: Bamboo		c. Ecology factor: Vernacular approach	
		c. Advantages of Modular Architecture		2: Wood		d. Culture factor: Integrated design approach	
		d. Modular architecture in Mauritius		5. The finish	81		
		e. An Inventory of Modular architecture innovations		Material proposals		3. Other advantages	94
				1: Earth		4. Possible improvements	94
				2: Bamboo			
				3: Thatch			
				6. Cost Estimate	84		
						Conclusion	97
						Bibliography and Annex	98

Introduction

Located in the Indian Ocean at 2000 km from the southeast African coast, Mauritius is a developing island state inhabiting 1.3 million people. Even though it has been recently classified as a high-income country in 2020 (World Bank, 2021), around 8.7% of the citizens still live in relative poverty, with 12.4% in urban centers and 8% in rural areas (IFAD, 2014). When put together with Rodrigues Island, the figure rounds up to 10% or 11,222 households. (Ministry of Foreign Affairs, 2019)

Despite the many poverty alleviation strategies of the State, including numerous social housing schemes, today Mauritius is facing a shortage of affordable housing, compelling people to continue to live in poor conditions. Secondly, this is also giving rise to many informal squatter settlements at different parts of the country and creating political controversies around the eviction of squatters from illegal structures, at Résidence Malherbes in Curepipe, Riambel, Pointe aux Sables and Le Morne for example. (GIS, 2020)

The bigger problem lies further ahead. Being a tropical island, Mauritius often suffers from violent cyclones and sudden downpours, leaving scenes of flooded or devastated landscape, infrastructure and homes. Obviously, the most affected and danger-prone citizens are those with poor living conditions, who forcefully have to leave everything behind and seek shelter in

refugee centers every cyclonic period.

But why is there such a shortage of housing now? A study mentions that it is due to “a combination of multiple factors including the most common of inadequate and ineffective housing delivery mechanism and more peculiar of limited availability of public land.” (Khan, 2019) Truth is that the actual construction of social housing itself is not efficient. The conventional construction method that has been adopted for all social campaigns since the 1960s is the concrete house, whose construction costs arise to MUR 16,000/m². (Interview Bunjun, 2020) While construction gets more expensive annually, more time is taken to gather the funds for the resources, machinery and manpower associated with concrete construction. The cultural and ecological factors are also neglected.

As a matter of fact, housing crisis is today a worldwide reality in various countries in situations of war, natural calamities, etc. This era has nevertheless brought in its wake new architectural movements and innovations. Modular technology presents many answers to a more efficient construction, in terms of cost, time and quality. Now coupled with traditional techniques like vernacular architecture, it is emerging as a sort of ‘modular-vernacular architecture’. This green concept can be seen in the work of contemporary architects like Shigeru Ban and Chris Precht, who are the main inspirations for this thesis.

Problem Statement

In response to the worsening housing shortage, poverty and squatter issues in the local setting, this research presents an architectural solution, a “Do-It-Yourself social house”, inspired by globally-known innovations:

“Can modular-vernacular architecture be a viable alternative for social housing in Mauritius?”

Viable does not mean only from the perspective of cost, but public acceptance, local climate, constructability, local resources, durability and maintenance are also essential factors to be considered. These can be elaborated to derive a set of sub-questions:

- Will such a modular building cost less than a traditional concrete building?
- Will local citizens approve of such a modular construction method, when for them a concrete house represents a safe habitat and a pride?
- Does modularity compromise the strength of a structure for natural materials or can it resist cyclones?
- Can modular construction help simplify building with natural materials for self-building?
- Which local materials are adapted for such a construction?

- What is the lifespan of such a building and its maintenance cost?

Structure and Methodology

Chapter 1 will be a literature review of the current social sector housing schemes and their related issues, followed by global trends in architecture that address public housing. An intensive research on green modular construction methods will be done and classified in an inventory, with their relative price when known, while constantly comparing them to the local context and market. Other relevant design approaches used in social housing will also be studied here.

Chapter 2 will present the preliminary analysis required for the design of the project and the project itself, a DIY social house. First, a SWOT Analysis will help expose the opportunities and weaknesses of the project to target. Interviews and survey will be used to collect data and opinions of professionals in the construction sector and the general public about current building methods and alternative methods. Information about local materials' costs will be gathered and listed in an Atlas. A social house concept will be designed and after experimenting with scale models, three building methods will be proposed. The Atlas will be used to estimate the cost of each proposal. *Chapter 3* will evaluate the project from each

perspective listed above. The three proposals will be compared in terms of cost and other benefits. The pros and cons will be weighed so that recommendations for future research can be elaborated at the end of the paper.

Aim

- The aim of this project is to propose a new, low-cost and green architecture for social housing in Mauritius through modular and vernacular architecture.

Objectives

- To find the best compromise of natural material adapted to the cyclonic local climate.
- To aid the government in providing social housing in a more efficient way.
- To enable low-income group citizens build their own house, without having to depend exclusively on public means and heavy equipment.
- To prevent people from building illegally, and rather promote a respectful architecture.

Limitations

- This work mentions factory-prefabricated structures such as container house but these are not further investigated because the main focus here is integrative or user-inclusive modular systems, as defined in Chapter 1.
- The aspect of disaster-resistance of modular construction and related scientific experiment or simulation is not the focus of this research, but relies on existing research on the subject.

Nonetheless, this study has been carried out so as to serve as a roadmap to build upon the proposed concepts, so that they can be further developed and even better proposals be derived for a local architecture.

1

BACKGROUND STUDY/LITERATURE REVIEW

A. SOCIAL HOUSING IN MAURITIUS

1. A history with climate
2. Issues in social housing
3. Positive aspects of social housing
4. Recommendations from researchers

B. ARCHITECTURAL MOVEMENT IN SOCIAL HOUSING

1. Modular architecture
2. Integrated design
3. Integrative approach

This chapter first provides a synthesis of the social housing sector in Mauritius, both in a historical and factual way. It tries to identify the issues of actual housing projects from different point of views: cost, time, ecology and culture. The second section is an exploration of the state-of-the-art in the field of modular architecture and exposes the relevant architectural movements that can be associated to social housing and that prove to be worth studying for this project.

A. SOCIAL HOUSING IN MAURITIUS

1. A history with climate

As per the UNDP report on social housing (Chagny, 2013), the history of social housing dates back to the 1950s, when one of the worst cyclones destroyed 75% of houses, which were back then built with traditional materials, and left 60,000 people homeless. The “Lakaz Lapay”, literally straw house, was made of an earth-cow dung mixture for floor, eucalyptus wood for structure, wood planks for wall, and thatch from dried sugarcane for roof. Some of these houses resisted the cyclones. (Ramessur, 2021) The Mauritian Government started its first mass housing campaign the Cités Ouvrières along with the British government and set up its Ministry of Housing and Lands in 1956. (Chagny, 2013)

Still recovering from the trauma, the island is hit again in the 1960s by two consecutive cyclones: ‘Alix’ and ‘Carol’ devastated 40% of houses on their way, making 80,000 people homeless. This time, the massive reconstruction is led by Sir Abdool Razack Mohammed and the newly established Central Housing Authority (CHA) in 1960. The damage was so important that wooden houses were discouraged by the authorities and concrete houses were built instead. Concrete rose as the “hero” of the story, marking a big change in the urban and rural landscape of Mauritius. (Ramessur, 2021)

However, the campaigns by the CHA proved unsuccessful. The houses were not sold, but rented to the people in need, who respected neither the rent nor the built environment offered to them. The apartment units also became the target of other income groups. All these led to the deterioration and ill-practice of these spaces. (Autar, 2012)

Finally in 1991, the National Housing Development Council (NHDC) took over the responsibility of the CHA and the Mauritius Housing Company Limited (MHC) was established to provide housing loans at favorable rates to low and lower-middle income groups.

The NHDC has constructed around 14,000 housing units till now for families whose monthly income is in the range of MUR 6,200 - 60,000. (€ 120 - 1200). (Interview Ramma, 2021) The houses proposed were 39 m2, although today 50 m2 units are being implemented.

Apart from the 3 schemes, Corrugated Iron Sheet (CIS), Concrete and Corrugated Iron Sheet (CCIS) and Integrated Social Housing Scheme (concrete house), the government has also set up the Roof Slab Grants and Purchase of building materials Scheme to encourage concrete construction. (MOHL, 2014)

2. Issues in social housing

However, the harsh history of social housing sector has still a long way to go. With the various squatter problems all over the news, Mauritius figured in a study in the International Journal of Advance and Innovative Research and was labelled as “a microcosmic representative of housing crisis in the Global South”. (Khan, 2019) The shortcomings of the field have been analysed in the architectural context and categorized as shown below.

a. Cost factor

The adoption of concrete has had both direct and indirect impacts on the overall cost of the housing projects. More resources, machinery and skilled

workers are needed to build the houses. The resources are subject to inflation as each year passes by as shown in the Table 1. (CCM, 2018)

One NHDC housing unit of 50 m2 being constructed nowadays costs around MUR1 million or €20,000 (Interview Ramma, 2021). To own this house, a first deposit of MUR 150 000 (€ 3000) is required by the house applicant (Mauritius National Assembly, 2020), which is exorbitant for a poor citizen earning roughly MUR 10,000 per month. Then, the rent is calculated based on the total monthly income of the family. A research (Subrun, 2017) mentions that:

“Rent is high compared to other countries and some households often spend more than 50%



of their earnings on rent [...] Many of these homeless individuals resort to squatting - which is a major social issue in Mauritius as pointed out by the current government (Soodhun, Government Information System. 2015): 'As the House is aware, there has been an extensive problem of squatting for decades now. This Government is bent on addressing very rigorously but humanely the problem, the more so because of its socio-economic implications'."

(Subrun, 2017)

Apart from the squatter issue, the high rent has burdened the sector with huge rent backlogs. In 2012, the debt of NHDC amounted to MUR 90 billion "with more than 3,000 owners failing to pay their rent regularly." (Chagny, 2013) Even the 2009 Corporate Social Responsibility (CSR) policy, consisting of profitable private companies to invest at least 2% of their profit into social help, did not quite improve the statistics. Being a welfare state has proved to be costly to the Mauritian government with "community and social services expenditure" being "the largest share of total government expenditure". (Autar, 2012) In 2020, Mauritius has sadly been classified as a high-risk third country and included in the EU blacklist due to the tremendous debts but also frauds, amongst others. Actually, the country is facing a steep recession due to the COVID-19

pandemic. (World Bank, 2021)

b. Time factor

Currently, the contract duration for an NHDC project is between 18 to 24 months (Interview Ramma, 2021), which is way too long. Prior to 2006, the government solely provided around 900 housing units per year, with a waiting list of 25,000 housing units. Then, the private sector was involved so as to provide 1500 units per year. (Autar, 2012) Nevertheless, this target could not be achieved. (Chagny, 2013) Today "the mean waiting time for the allocation of an NHDC housing unit is 2-3 years", including the long processing time for "completing, executing and handling over completed projects to beneficiaries". (Subrun, 2017) The demand has always exceeded supply and this is why if no solution is found rapidly, the housing shortage will only worsen as years pass by, together with the illegal settlement issues.

c. Ecology factor

"Despite stable energy demand, energy-related CO₂ emissions from building operations and construction reached their highest level ever recorded in 2019. Together with manufacturing, transportation, and use of construction materials, they account for 38% of global CO₂ emissions." (UN Environment Programme, 2020)

Table 1

Input Categories	Weight	Percentage increase in the construction price index						
		2013	2014	2015	2016	2017	Total	Average
LABOUR	28.2	2.7%	3.7%	4.5%	1.1%	0.9%	12.9%	2.6%
HIRE OF PLANT	3.3	3.4%	1.1%	0.0%	0.0%	0.0%	4.5%	0.9%
MATERIALS:	64.2	2.4%	0.5%	0.2%	-0.5%	0.7%	3.3%	0.7%
Hardcore	1.8	2.0%	0.6%	0.0%	0.0%	0.7%	3.3%	0.7%
Cement	12.7	8.9%	1.2%	1.5%	0.8%	0.0%	12.4%	2.5%
Sand	4.2	1.3%	0.4%	0.0%	0.0%	0.8%	2.5%	0.5%
Aggregate	3.4	2.3%	0.7%	0.0%	0.0%	1.0%	4.0%	0.8%
Block	5.2	3.7%	4.5%	0.0%	0.0%	2.3%	10.5%	2.1%
Steel bars	10.6	-3.0%	-3.2%	-3.8%	-6.7%	1.3%	-15.4%	-3.1%
Galv. corrugated cast iron sheeting	0.6	0.0%	-2.2%	-2.4%	0.4%	0.1%	-4.1%	-0.4%
Timber:	3.9	2.2%	0.9%	2.8%	0.9%	0.7%	7.5%	1.5%
(a) Carpentry								
(b) Joinery	1.6	2.2%	0.4%	0.5%	0.6%	0.7%	4.4%	0.9%
Aluminium openings	4.1	0.4%	0.0%	0.0%	0.0%	0.0%	0.4%	0.1%
Metal openings	2.7	0.3%	0.2%	0.2%	-0.1%	-0.1%	0.5%	0.1%
Ceramic tiles	0.8	7.3%	4.1%	4.4%	2.3%	0.4%	18.5%	3.7%
Adhesive	1.7	0.6%	0.2%	-0.2%	0.4%	1.0%	2.0%	0.4%
Paint	2.5	4.2%	2.7%	2.3%	3.7%	0.9%	13.8%	2.8%
Plumbing	1.5	0.4%	-0.2%	0.0%	0.1%	0.0%	0.3%	0.1%
Sanitary installation	2.2	0.7%	1.5%	2.3%	0.2%	3.3%	8.0%	1.6%
Electrical installation	4.7	0.5%	1.1%	0.3%	0.3%	-0.8%	1.4%	0.3%
TRANSPORT	4.3	0.0%	0.0%	0.0%	0.0%	0.0%	0.0%	0.0%
Total	100	2.4%	1.4%	1.4%	0.0%	0.7%	5.9%	1.2%

The conventional construction method in Mauritius involves concrete, which is not an eco-friendly material. Its manufacturing process involves much pollution and the material itself is non-biodegradable. It has poor insulation and its overuse in the urban context has led to floods.

Moreover, since it is not conceived to be recyclable, it has to be demolished at the end of its life cycle. As a matter-of-fact, the redundancy of buildings is a largely undermined issue here. (Survey, 2021) For small developing countries like Mauritius, the tendency to focus on innovation rather than resiliency is normal, as compared to countries that have attained the peak of their development.

d. Culture factor

As mentioned above, concrete requires heavy machinery, equipment and skilled labour. Upon its arrival, it got suddenly harder for the poorer citizen to build a safe shelter, creating the builder-user gap and reducing community building. This however is true only to some extent, since now people are used to concrete construction and like to participate when they have the occasion. (Interview Bunjun, 2020) (Survey, 2021)

Secondly, it is a problem deeper than just the building technique or material. Social housing are basically isolated building agglomerations.

“Due to the availability of the land, the low income housings are often located far away from amenities and jobs, thus compromising the principles of accessibility, affordability and acceptability in the housing adequacy. It is not surprising to know that the result of this situation is that 15% of the government low income housing is abandoned in Mauritius.”

(Khan, 2019)

As a consequence, spaces are not valued enough. Respecting one’s community space and expressing some sense of belonging is not always understood by everyone. Maintenance thus often becomes tiring and costly for the state and is eventually abandoned. They tend to quickly become redundant spaces where one would not venture, just as the CHA campaigns mentioned in section I.A. 1.

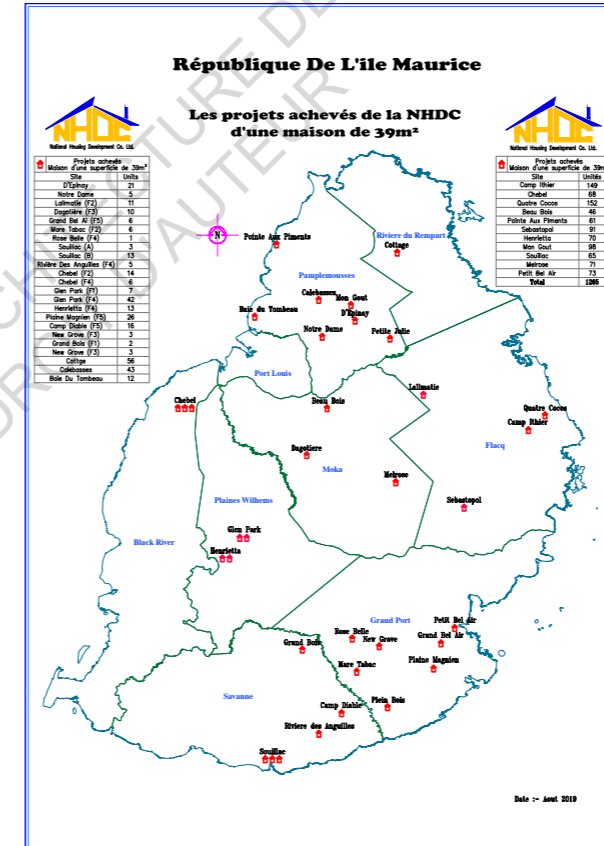

Completed 39 m² projects by NHDC until 2019 (nhdcmauriti.us.com)

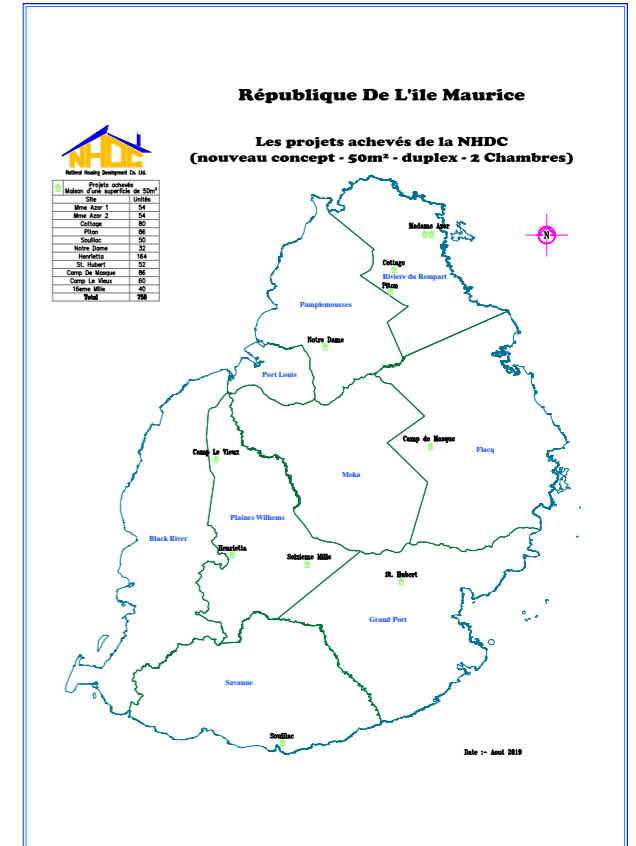

Completed 50 m² projects by NHDC until 2019 (nhdcmauriti.us.com)

3. Positive aspects of social housing

Although the government's social housing campaigns are slow and not always transparent, (Subrun, 2017) they are well-planned, especially in the technical aspect. "The units are provided with all necessary amenities: water pipes, electricity supply, sanitary wares, etc. They are also serviced by networks of road, footpath, drains, sewage disposal, water pipes, street lighting and social amenities." (Interview Ramma, 2021)

NHDC houses are in a sense modular and practical since they are "designed in such a manner to allow beneficiaries to extend their dwelling, according to their needs and financial capability. The average plot size is 200 m² and adequate space is available for lateral and vertical extension of the units." (Interview Ramma, 2021)

New housing estates are now based on Integrated design: they include various community facilities such as kindergarten, recreation and training facilities, religious buildings, garden, post office, etc. (Chagny, 2013) After thorough statistical analysis, a researcher came to the conclusion that "though the NHDC program is far from an ideal one, it does improve upon the livelihood of its beneficiaries". (Subrun, 2017)

4. Recommendations from researchers

"Develop architectural housing alternatives to allow for more dense housing units respecting cultural factors of the low-income group. Social housing adapted to Mauritian way of life: architectural models could be developed to answer need for privacy but also higher density housing instead of individual core housing to save land and save costs of infrastructure. Consider architectural housing models developed for the sugar estates, or other models that take into consideration the climate and ways of life of inhabitants."

(Chagny, 2013)

"The Ministry of Housing should implement advanced design strategies and sustainable infrastructure; low-cost housing should be environmentally friendly and livable for people that can be adopted for social housing."

(Subrun, 2017)

B. ARCHITECTURAL MOVEMENT IN SOCIAL HOUSING

Today the main concern in the construction field is *sustainability* and Mauritius is well aware of it. Its development strategies do address the theme, but not enough, which is why it is lagging behind. Mauritius should learn from the example set by its neighboring countries, Africa for example, where green materials have always been used for building. At a global level, concepts such as Circular economy, Resilient buildings, Integrated (holistic) design and Integrative (participatory) design are being implemented in many sectors including emergency architecture and social housing. The Cradle-to-Cradle is also a trend in design that targets 100% biodegradable products. Local architects are among the ones that can make a difference through design and achieve greener and healthier habitats.

The two main references for this project have been Shigeru Ban and Chris Precht for their particularly impressive approach towards affordable and green architecture by using modular and vernacular principles. This is why their vision and works will both figure in this section, along with other very important references.

1. Modular architecture

“A building has a life of its own [...] which can be divided into 5 phases: Starting, Designing, Building, Using and Deconstructing a building, which is heavily overlooked. As ourselves we have a lifespan, the same goes for buildings: at a certain age they get old and need to be deconstructed. We are living in an age where resources are getting scarce. So, we need to find ways of how we can actually reuse building materials in an afterlife of a building. So, it’s about how we live with, not in a building.”

(Precht, 2018)

A building’s linear life can be turned into a cycle through circular economy as shown in the figure below. This consists of recycling the materials of the building that would go to waste once the building is of no use. Modular architecture can help in bringing this change.

The typical life cycle for a building and which stages and processes are involved.

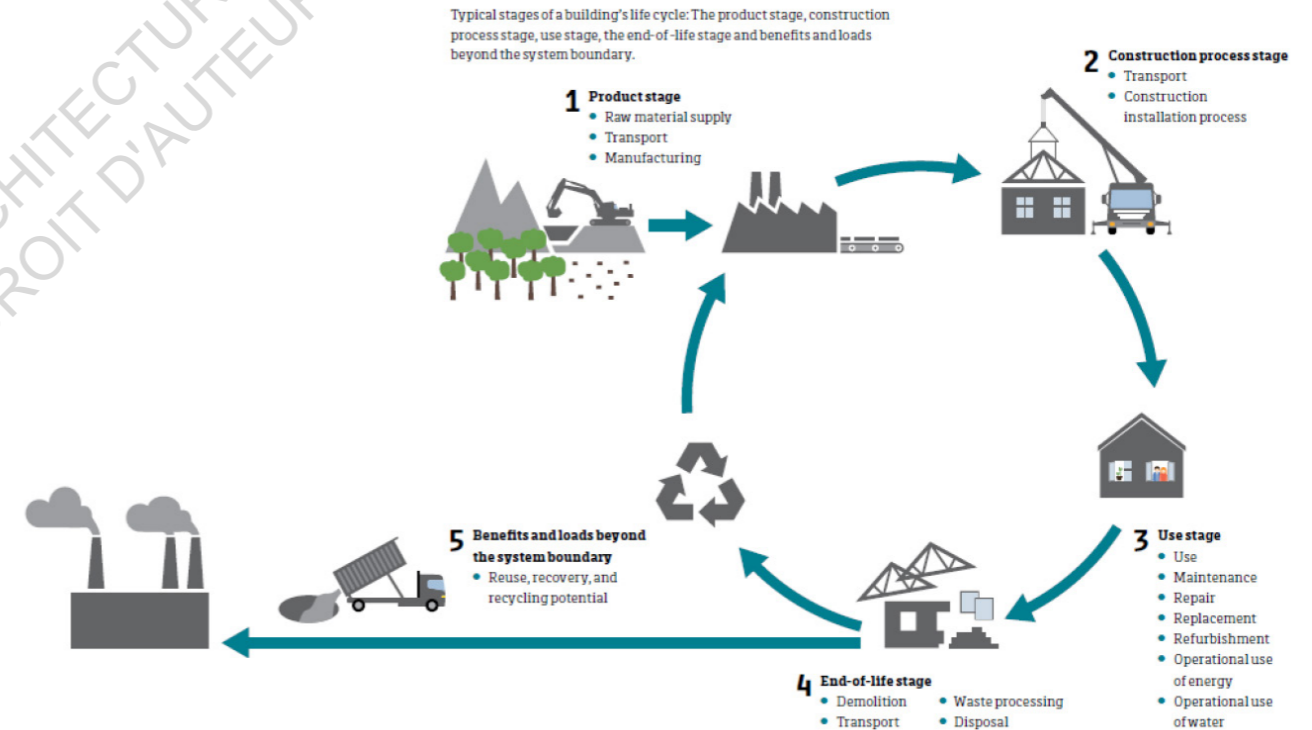

a. Definition of modular architecture

“A modular principle offers to build complex product through the integration or assembly of smaller modules or subsystems which are developed independently but function together as a whole. This type of architectural system contains modules that can be used as self-contained building blocks for high-level systems. Each module will interact with another through standardized interfaces that define functional spatial and other relationships among the components.”

(Zafuan et al., 2014)

In other words, a modular building is similar to a LEGO game, the modules can be rapidly assembled to constitute a building. Depending on the materials used, once the building has served its purpose, it can either be disassembled to reuse the modules; or it can be recycled completely.

Among the first pioneers of modular architecture, there is Jean Prouvé with the 8x8 houses in the postwar period of 1940s and Le Corbusier with the Domino House in the Industrial Revolution period. (Delahaye, 2013) Other famous examples include the Capsule Tower or the Habitat 67. (Jones, 2016) However, these examples are now outdated. Modularity today has really changed to

adapt to contemporary needs and challenges as will be discussed later in this section.

b. Types of modular architecture

There are two types of modularity in architecture: one based on modular construction and the other on the use of space. This research will focus on modular construction.

Modular construction can be further divided into “whole building” module and “building component” modules, which is more user-integrative.

c. Advantages of Modular Architecture

Modularity makes optimum use of the technology of our era, making the building process more efficient in many ways.

- Quick: Modular buildings are rapidly assembled, reducing the site mobilization period. It is for emergency architecture. A recent example is the Wuhan Hospital of 60 000 m² that was built in only 10 days. (Ankel, 2020)
- More cost-effective: less workers are needed as compared to traditional construction, cutting the labour costs.

- Improved quality: Modules are produced in a controlled environment, ensuring an overall better quality.
- Easy: Its simplified construction makes it easy for anyone to understand, encouraging participation, experimentation and involvement in creating one's own habitat, reducing the builder-user gap. It is a more democratic architecture.
- Flexible: It can be modified easily, incremented and adapted to various designs, contexts and functions.
- Durable: It improves maintainability and life-time of the building. (Zafuan et al., 2014)
- Green: It can be disassembled and needs not to be demolished, making it recyclable. It is like an architecture that can ‘disappear’ when it is not needed anymore.
- Experiment-friendly: Prefabrication has also proved to bring design and construction processes closer together, reducing the designer-builder gap. (Precht, 2018)
- Innovative: Finally brings on the utmost front the option for more LOCAL sustainable materials and decreases construction pollution.

d. Modular architecture in Mauritius

Modular architecture in Mauritius is relatively new. In the local construction industry, we can find both types of modules are being increasingly used:

- whole building module

Velogic Mauritius delivers container houses while Karmod has a flat-pack option for prefabricated buildings. KOTO also proposes Structural Insulated Panel (SIP) houses.

- building component modules

blocks (traditional and smart blocks from UBP, American blocks), bricks (concrete or clay), prefab slabs (concrete), partitions (aluminium, wood, plaster, SIP) and standardized openings too can be considered as modules

e. An inventory of modular architecture innovations

What are the current innovations in modular architecture worldwide and how can it be applied in the local context?

Among the numerous inspirations and references presented in this section, there are two particular architects, Shigeru Ban and Chris Precht, whose vision are worth-mentioning beforehand.

The Japanese architect Shigeru Ban, known for his disaster-relief projects, believes in the “physical and emotional reconstructive potential of architecture.” His experiments aim towards using “ordinary materials in extraordinary ways.” Using modest materials like recycled paper, cardboard, or natural materials like bamboo and wood in a modular way, easy for anyone to build, he comes up with affordable housing solutions, not only in the emergency field. His “structural solutions” are far more humane solutions and are an example to follow for a greener tomorrow. (McQuaid, 2006)

As for the Austrian architect named Chris Precht, he is a fairly young architect but whose vision meets Ban’s. Although his projects are more directed towards nature and bringing agriculture in the city rather than emergency solutions, his architecture shares the concept of mixing modularity and vernacular. He is also interested in

experimenting alternative building methods, with the aim of creating a more respectful architecture.

Hence below is an Inventory of a range of modular building techniques in both the social housing sector and emergency architecture that were deemed relevant to the project. They have been classified by the material used for a better understanding. A critical analysis also helps to compare to the context of Mauritius.

Wood

i. U-Build, UK (self-build)

This DIY flat-pack by Studio Bark is entirely constructible by the user himself. It is only made of wood, screws and insulation. (Crook, 2019) However it is very costly, quoted £900 per m² (MUR 53,000) for the house option. (U-Build)

ii. Brikawood, France (self-build)

It is a quite similar Do-It-Yourself kit with wooden bricks, but without any screws, instead an interlocking system. (Brikawood) A small 20 m² cottage as shown below can be completed in 2 days with a small team. (Brikawood TV, 2016)

The modular and self-build U-Build Kit

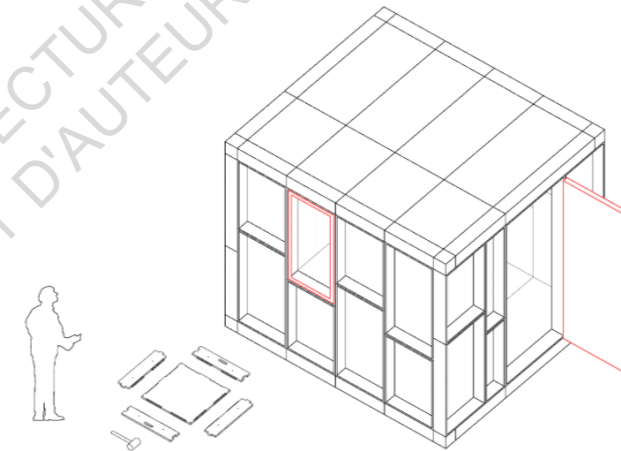

Internal Width	210
Internal Length	240
Internal Height	210

Brikawood's brick module and its small self-build cottage



iii. Gablok, Belgium (assisted self-build)

Assembled in modular OSB blocks interlock without the need for any adhesive. The insulation is Expanded polystyrene (EPS) with graphite additive which is recyclable. A 2-storey house, without finish, can be completed in 7 days by a small team. (Gablok, 2019) The finish can be plaster or cladding. The modules are illustrated through a user-friendly platform online. (Gablok) But no precise indication of price was found.

Gablok modular OSB blocks being assembled on site and technical model of module variations corresponding to different building components.

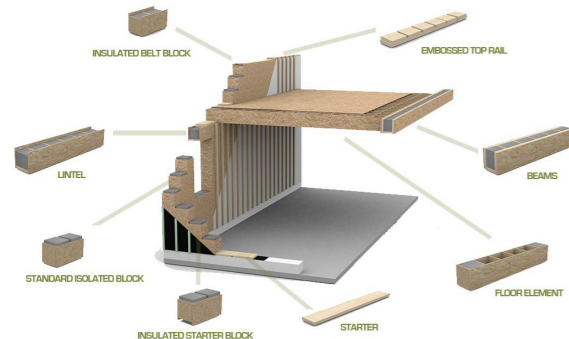

iv. Cross-Laminated Timber (CLT), concept (participative)

Part of Precht's urban vertical farms concept, Farmhouse is a modular building made with prefabricated A-frames of CLT. Based on a grid, it can be small or a multi storey tower.

Each wall has 3 layers: *finish and plumbing; structure and insulation; and gardening elements and water supply.* The hands-on approach **lets users choose the modules they want:** *structural and gardening elements, waste management units, water treatment, hydroponics and solar systems.* It is an "architecture that is home-built with food that is home-grown." (Precht)

Mauritian context: Wood is expensive since it is not a local resource but it was extensively used in construction of colonial houses in the past (Ramessur, 2021), as structure, flooring, wall cladding, roof shingles, etc... The ideas of making modules of ergonomic size and letting the users choose the module suited to their needs to equip their house are principles to implement in the project.

Precht's Farmhouse project with different configurations



Bamboo

The high-performance and ultra-economical technology of bamboo is a known fact now. Experiments have proved that bamboo has “twice the compressive strength of concrete and roughly the same strength-to-weight ratio of steel in tension”, and thus can be used for long spans in architectural design. (Zafuan et al., 2014) It is also earthquake resistant. (Hamot, 2017)

i. Modular Bamboo Hotel, China, concept (participative)

Designed by Precht in a competition, One with the Birds is also based on a flexible grid. The bamboo elements are tied together using X-shaped bamboo joints, that in turn allow for horizontal elements to support the floors. Since the bamboo are not bolted or pierced, they keep their strength, thus can have different configurations and scales, from individual rooms to collective towers. (Tebbutt, 2014) A Pavilion based on this concept was also made for the Beijing Design Week. (Precht) Just like this building is light enough to be disassembled, transported and reassembled elsewhere, a similar portable low-cost building was proposed by a student but for slum dwellers in Dhaka. (Holcim Foundation. 2015)



One with the Birds modular hotel's bamboo assembling techniques, design variations and prototype made for the Beijing Design Week.

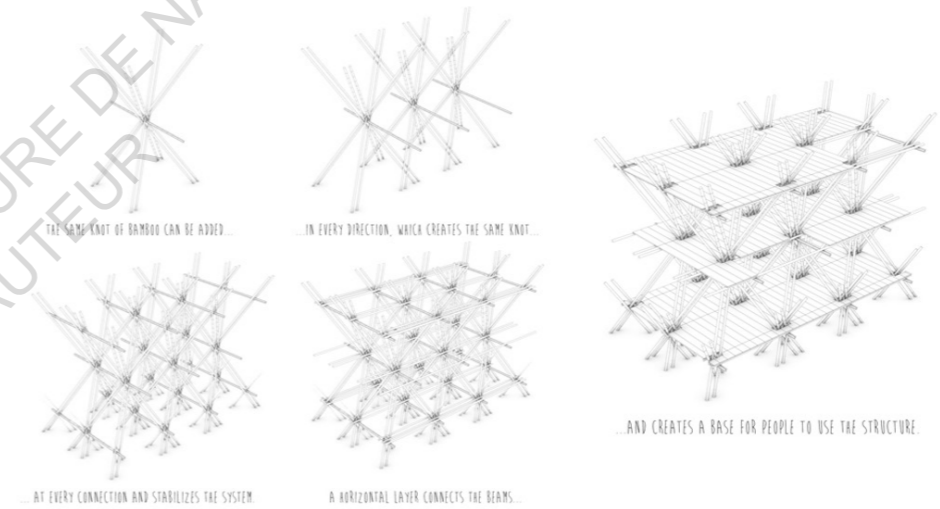

ii. Bamboo Living, Hawaii (participative)

This is the only agency whose prefabricated bamboo houses are currently certified for their strength and sustainability. (Interview Martin, 2021) “Homes were put to the test in the islands of Rarotonga when three category 5 hurricanes hit in February, causing extensive damage or completely demolishing most of the timber structures. But even 173mph (278 km/h) winds couldn’t blow our Bamboo Living bungalows down.” (Bamboo Living) The users get to design the home with engineers and architects but once delivered needs professional assemblers.

Bamboo Living’s modular house being prefabricated in the atelier before being flat-packed and shipped to the client.



iii. Bamboo Modular System (BMS), Malaysia (assisted self-build)

A group of researchers, students and consultants built this prototype for a bus shelter in bamboo, an available resource in the tropical climate of Malaysia.

They selected the bamboo species *Gigantochloa scortechinii* on the following criteria: anatomical properties (fiber length, vascular bundle distribution, size), physical properties (moisture content, density, shrinkage) and mechanical properties (shear, compression, bending strength). These criteria help define the suitability and compatibility for different uses (industrial use, construction or housing).

Bamboo Modular System proposal for a bus shelter, the wooden joint, the cube module prototype and the team at the Workshop construction process.



The module as shown below is a 375mm-length cube, proportional to the weight and length of span of the structure.

Modular technology was used to enhance durability and **practicality** of bamboo, in view of making it a more **acceptable** construction material. As a matter of fact, costs and energy used were minimized. Applying modular principles not only impacted the design, but also indirectly commercialized bamboo as a contemporary building style. (Zafuan et al., 2014)



iv. low cost bamboo housing, Vietnam (assisted self-build)

In the middle of a hot and flood-stricken region, this modular building can float in floods, while staying anchored. It is made of minimal components and bamboo module units, and uses other locally available resources as leaves and recycled oil containers. It costs less than \$2000 or MUR 86,200 (€ 1700). (H&P Architects, 2013)

Assembling techniques used in the floating low-cost bamboo by H&P Architects (floornature.com)

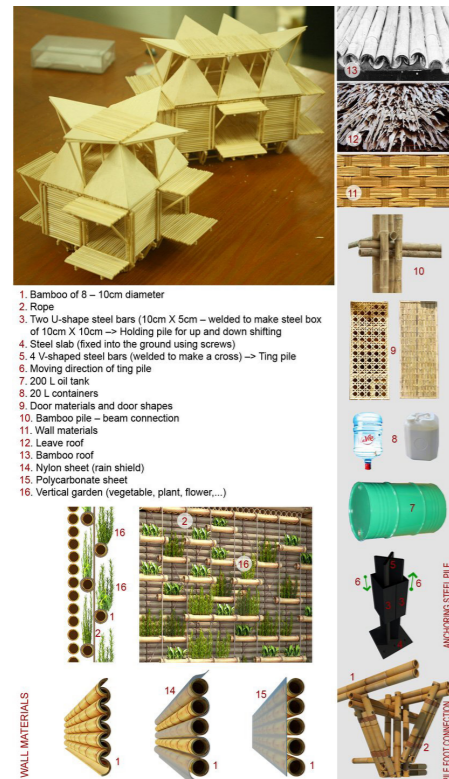

Mauritian context: Even though bamboo is cheap, the current obstacles to using bamboo for construction are limited resource and lack of skilled labour to adapt structures to local cyclonic conditions, as they do in Bali for instance. All of these make bamboo construction as costly as concrete. However, it is still less costly than wood. (Interview Martin, 2021) Therefore, if bamboo is cultivated and a self-build modular system is used, costs can be considerably reduced. The prefabrication of modules by local people themselves or by local micro and small-scale enterprises saves on project costs and creates jobs too. (Velasco Espín, 2016)

3D-printed joints including Bamboo U joint (SMITH, 2017); and plant-based polymer PLA bridge (Dobbins, 2018).

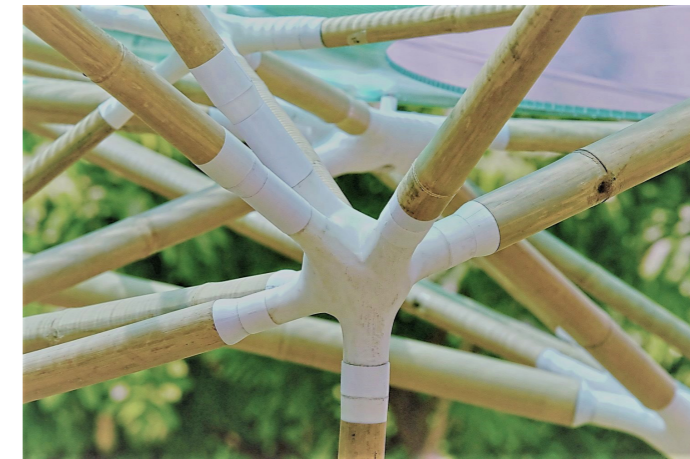

Earth/clay

i. Mud Bricks and Compressed Earth Blocks (CEB), Kenya (self-build)

Alongside UN-Habitat, Ban had to design permanent shelters for over 17,000 refugees in the Kalobeyi settlement. He proposed 3 prototypes instead of 1, so that the people themselves choose the one they prefer: Type A is with paper tubes including local weaving technique; Type B was earthquake-resistant with modular timber frames and mud bricks infill; and Type C was with interlocking soil blocks or CEB. (Shigeru Ban Architects, 2018)

However, a second visit made him conclude that importing paper tubes or mass-production of bricks were not feasible or required skilled labour. Rather, a branches-wood-bricks combination was most suitable but did not provide enough privacy. (Stevens, 2018)



ii. Malaysian Interlocking Bricks (MYIB), Malaysia (self-build)

Among the most affordable interlocking bricks on the market, MYIB are made from a soil and cement mixture which is compressed and cured. It is structural since steel reinforcement bars are placed at regular intervals when dry-stacking the bricks. Less cement is needed as compared to traditional concrete construction and it is rapidly built by only few people. (MYIB)



A Malaysian Interlocking Bricks column being reinforcement by steel bars and a completed public housing.



iii. Superadobe, Mexico (self-build)

This earthquake resistant construction method involves filling polypropylene bags with a mixture of earth and lime. Once these are stacked on top of each other, the walls are caked with three layers of dirt, lime, ground grasses and horse manure. (Frye, 2019)

Mauritian context: Francis Kéré's architecture teaches us that local earth has always been part of the vernacular architecture of Africa and it is perfectly adapted to the climate too. In Mozambique, clay bricks are cheap, easy to produce, and also provide thermal protection against the hot climate. (NIU and JI, 2017) But since Mauritius is of volcanic origin, clay is a scarce resource which makes production of clay bricks impossible.

Nevertheless, earth as a non-structural material is an option to consider since earth mixed with cow-dung was used in the past for plastering and flooring purposes. The earth from site excavation works, normally a waste material, can itself be used for this purpose, hence decreasing the overall investment on materials.

Superadobe-filled bags being covered with another earth mixture, next to finished superadobe houses at the Cal-Earth Institute



Concrete

i. Concrete fabric shelter, concept (self-build)

The Cortex Shelter or “just add water” concrete shelter by Cutwork is a flat-pack housing solution to the refugee crisis. It combines modular steel structure with a flexible concrete fabric that hardens in place when hydrated. It can be self-build by 2 inexperienced persons in one day and is ready for use 72 hours after hydration. Its life expectancy is of 30 years (Nelson, 2019)

The concrete fabric uses 90% less material than traditional concrete while having the triple compressive strength. (Cortex Composites) The estimated price of a 24 m² unit is \$4000 (MUR 172,000 or € 3400) and is expected to be reduced soon. (Valeur, 2019) Even though it is difficult to consider concrete fabric in a circular economy approach, it has many more eco-friendly properties than traditional concrete, explaining its use in sensitive sites. (Concrete Canvas)



Mauritian context: Concrete roll is already used in slope protection, ditch-lining and other local infrastructural projects. But it is difficult to consider this material in the circular economy concept.

Even if the steel and interior fittings can be disassembled at the end-life, the concrete fabric is not recyclable. This however brings to light the question of a concrete roll but with a greener material like earth. Textile-reinforcement for earth construction has been studied for earth blocks (Widder, 2017) but no research has been found for an “earth fabric”.

The bendable steel sandwiched between insulation and concrete fabric and the Cortex shelter being assembled in-situ.



Unfolding structures

i. Nomad Folding Flax Pavilion, Spain (participative)

A group of students and tutor at the Institute for Advanced Architecture of Catalonia designed and built this temporary prototype for a festival in Barcelona. It is a lightweight origami-inspired structure made with a digitally manufactured bio-composite. The bio-composite consists of timber frames and jute fibres strengthened by Colofono resin (pine resin and olive oil). The jute thread was weaved on the frames by the Kuka tool.

To ease transportation, the folds were made deeper while making sure to optimize usable floor plate using Rhino Grasshopper. The pavilion is thus a flexible, portable shelter that can be assembled by few persons. (Bainbridge, 2017)

ii. The Folding Bamboo Architecture, concept (participative)

Designed by a student, this lightweight modular structure is inspired from the logic of origami, studied with Grasshopper with the aim was to have a strong, green foldable hotel or museum that can be transported easily and installed quickly. (Lu, 2015)

The Folding Bamboo Architecture designed on Grasshopper and the scale model experiment.

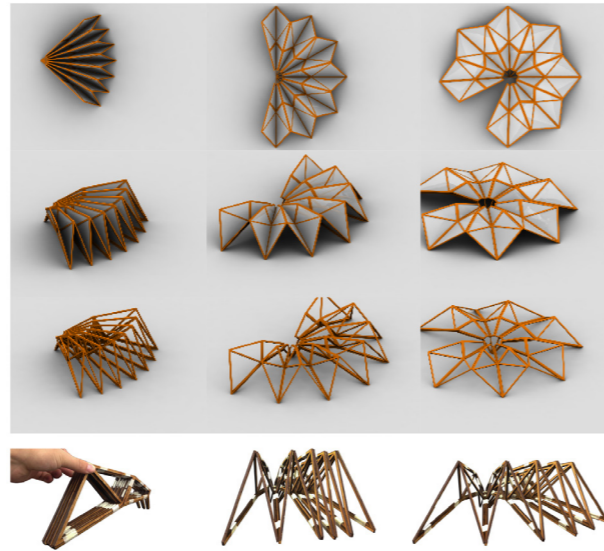

Mauritian context: Until now, folding mechanisms have been used only for architectural elements like openings, in modern houses as in traditional iron sheet houses 'Lakaz Tol' or popular stalls of small businesses like street food or shop 'laboutik' in creole language, shown below.

Mauritians like handiwork and many are skillful when it comes to making these types of structures which costs less than wood. Wood like pinewood and plywood are relatively cheap and are often used to make furniture. In order to make an unfolding house, these woods would be the most suited.

The Kuka tool weaving jute fibres onto timber frames and the resulting Nomad pavilion.



A popular sight in Mauritius: a food stall made of corrugated iron sheet. (Air Mauritius)



Straw / Thatch

i. EcoCocon, Lithuania (participative)

These 98% natural modular building method are compressed straw in double frame panels of wood. They are certified fire-resistant, especially when plastered with clay plaster. Similar to the Bamboo Living, the house is assembled by professionals. (EcoCocon) The Solar Kit House of 61m² costs € 23450 or MUR 1.2 million, which is around the same as local construction price of a concrete house. (Jensen, 2020)

ii. Straw-bale houses, Ohio, research (participative)

Southeast Ohio, like Mauritius, has high humidity levels and cyclonic conditions. The trouble of moisture accumulation in straw-bale walls has deterred people from using this abundant local resource. However, a 10-months investigation was carried out on the moisture content of 3 local straw bale homes, to conclude that properly built straw homes were not affected by moisture levels. Rather, the houses that had unelevated base, unstuccoed walls, bad footer system, small overhangs and moisture barriers at the straw-stucco interface, had the highest moisture content. Also, straw-bale houses have different environmental impact, depending on all the materials used during their construction, as shown in the table below. (Marks, 2005)

EcoCocon panel being assembled and a completed project, the Solar Kit House.



A classification of Construction materials used for Straw-Bale houses and their environmental impact.

	High-Impact	Mid-Impact	Low-Impact
Foundation	Concrete	Rubble Trench	Rammed Earth
Roof Covering	Shingles	Clay Tile	Thatch
Roof Insulation	Fiberglass	Straw	Recycled Cotton
Interior Walls	Concrete Block	Straw-bales	Adobe
Bale Assembly	Steel Rebar		Bamboo Stakes
Bale Wall Finish	Cement Stucco	Lime Plaster	Earthen Plaster
Floors	Tile	Concrete	Adobe



Mauritian context: Straw-bale walls when compacted and plastered have been proved to be more fire-resistant than wood (EcoCocon) and provide effective insulation. Straw is an abundant resource that can be obtained from sugarcane plantations, that account as much as 85% of Mauritius cultivated lands. Normally, bagasse is used for bioenergy and molasse or feedstock (Kong-Win Chang, 2013), but can be used for construction purposes too.

Thatched huts with pine log structure were recently built at Le Morne National Heritage. Each hut of 20 m² had cost MUR 250,000 due to local craftsmanship getting more and more scarce, as explained by the architect in charge, Dharam Bunjun, and a local officer of Le Morne Heritage Trust Fund on a site visit.

A classification of Construction materials used for Straw-Bale houses and their environmental impact. For low-impact houses



Recycled materials

i. Paper log house, India. (self-build)

The Paper Log house is a modular or rather “modular-vernacular” building example because a maximum of locally sourced materials was used. The one in India was made with cane matting which is a famous local craft and bamboo, coupled with paper tubes and plaster or steel reinforcement.

The two main challenges Shigeru Ban faces with paper architecture are structural, i.e. the adequate safety ratio cannot be guaranteed; and legislative, meaning the confrontation with local authorities who need to ensure all conditions applying to permanent buildings are met, which is complicated for paper as it is not a conventional building material. (McQuaid, 2006)

ii. Recycled rubble blocks, The Netherlands (self-build)

Mobile Factory was designed especially for victims of war or natural disasters to construct their own earthquake proof homes out of construction debris, as shown in the images below. (The Mobile Factory, 2018) The machine turns rubble into a liquid concrete, which is then moulded into lego-like bricks, Q-Brixx. These are stacked without the need for mortar; they hold in place by gravity. “One Mobile Factory alone can produce enough bricks to construct between 10 and 20 new houses..” It is an easy, quick, and inexpensive solution for sustainable emergency housing. (Material District, 2016)

Mauritian context: Recycling in Mauritius mostly concerns only industrial products like plastic, paper and aluminium. Many associations and companies are engaged in sorting and collecting recyclable wastes, but only plastic and electronic wastes are recycled locally (BEM Recycling). The rest has to be exported, for example tyres to South Africa, paper to India, etc. (Fakudeen, 2019) Upcycling is also practiced by small business nowadays. (Discover Mauritius)

Local recycling mill for construction is thus not considered feasible for the moment. But the Mobile Factory could be an answer.

The Paper Log House in India; an exploded view of its different components

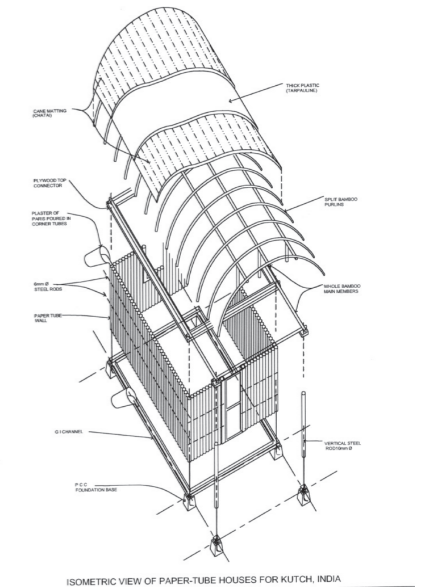

The Mobile Factory that is used to make rubble blocks and the houses that can be made out of it.

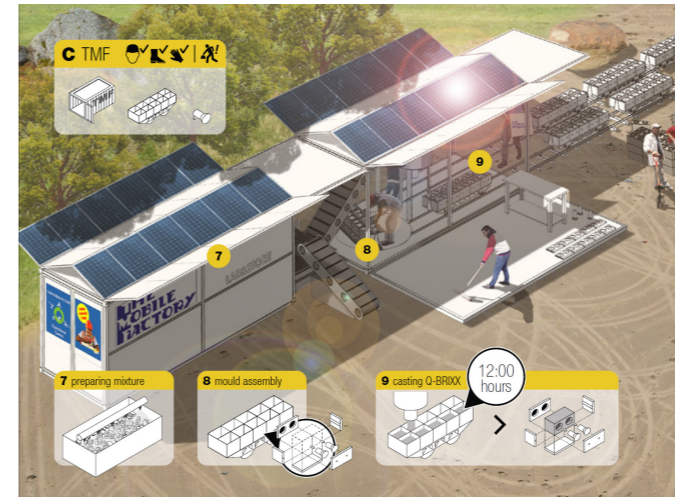

2. Integrated design

Shifting the point of view from construction to the architectural process itself, it is interesting to note that a higher number of social house projects are being addressed using a community-based approach during the design phase. Even Mauritius is implementing this approach as previously highlighted in section I.A. 3.

The architects ZD+A and Iñaki Echeverría have criticized Mexico's social housing campaigns of being "a blind production of housing and settlements which are practically unlivable". They argued, through their colorful participative proposal for INFONAVIT shown below, that citizens should be considered "as artists of the city, shaping the accessibility of services, mobility, family life, green spaces, the creation of common spaces, the offer of cultural and leisure activities." (Zatarain, 2017)

The architect Tatiana Bilbao in Mexico designed a social house with a 43 m2 solid core, costing \$8000 (MUR 340,000), that could be incremented with lighter and cheaper mini extensions, without ever looking 'unfinished'. (Cruz, 2015) Even though the houses were later criticized for producing "confusing results" (Arámburo, 2016), the project had a generous thought behind: a liberty in the function of the spaces, that allowed for

residents who are entrepreneurs to set up their small businesses: garage, snacks, crafts studio, shoemaker, carpenter, aluminium worker.. This design approach can be very useful for Mauritius since these kinds of small businesses are also very popular here. We have to understand that we are building villages and not refugee camps.

3. Integrative approach

The Integrative approach is a general approach used in design in an attempt to make a more democratic architecture, i.e making it accessible to everyone, not only financially. Participative, Self-build, Do-It-Yourself.. these are all integrative design approaches, that are easily applied through modular architecture as shown by previous examples. The latter illustrated the integration of people through the **construction process**. Participative construction was well-imbibed in the culture of Mauritians back in the time of traditional constructions like "Lakaz Lapay" (see section I.A. 1) The arrival of concrete and other construction technologies has decreased the number of people making their own house. However, the culture has not faded away yet since people still like to get involved. (Interviews/Survey, 2021)

ZD+A and Iñaki Echeverría project for INFONAVIT "From territory to inhabitant"



Tatiana Bilbao's social housing proposal with modular spaces thought for the differing occupations of residents

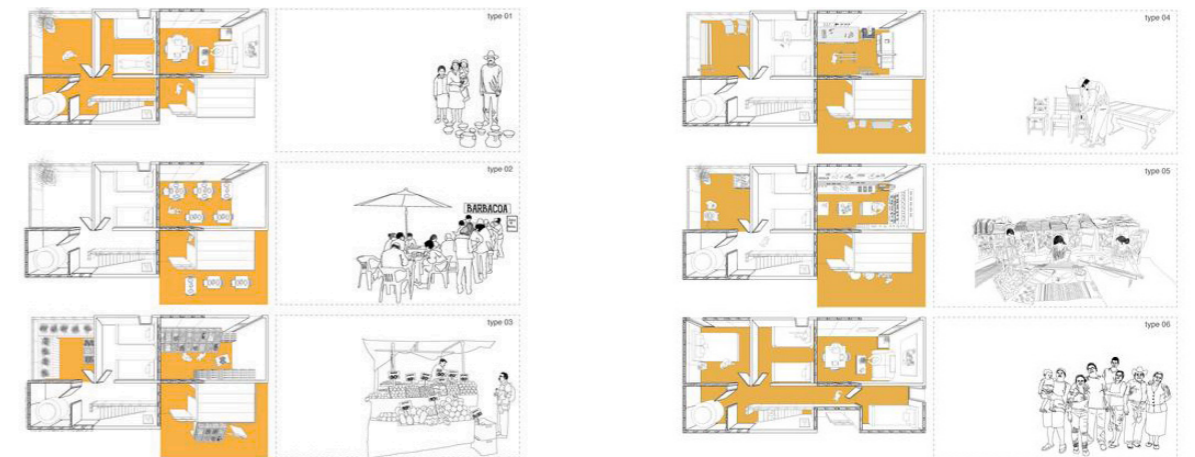

Apart from the construction process, residents of social projects can be in the **design or creative process**. In Thailand, squatter settlements are also popular. A project initiated by the local Community Organization Development Institute, CODI, consisted of gathering the 325 households concerned and working together with them on their new village. Through a video, they show how an integrative approach allows everyone to learn the basics of space planning while they sharing their thoughts and needs such as privacy to nourish the design. (Boon-Long, 2009) Community architects thus have a potential to guide people in the urban design configuration of social housing projects. (Boano and Kelling, 2013)

The famous **Half-a-House** concept of Alejandro Aravena involves users in the **creative process**. It refers to voluntarily uncompleted structures that are appropriated by users who complete the other half of their house based on their own choices and means. This also reduce the initial investment to about \$7500 or MUR 320,000 (€ 6760) for 30 m2. (Zilliacus, 2016) This project can be considered as an example of doing the opposite of architectural consensus or "**an architecture of dissensus**". (Boano and Kelling, 2013)

In Mauritius, some social housing projects have successfully implemented this approach. For example, in the *Village des Salines* project by

the private company Société Koenig Frères, the inhabitants were interviewed at different steps and designs were modified as per their needs. (Chagny, 2013)



Alejandro Aravena's Participatory design in Renca.

Conclusion

This chapter was a review of existing literature and documentation that has been carried out in the field of study. First, the issues of social housing sector in Mauritius were diagnosed, by digging elements from historical and recent documentation. Then an extensive research and inventory of new architectural approaches was done which, when compared to the local context, proved to be a rich analysis to further the thinking process.

This review also made obvious the literature gap that exists in the field. Very few research covers the subject of public housing in our island; as for a possible green approach to architecture in Mauritius, no research at all was found. The importance of this study is now evident and must be led in such a way to assist other researchers or architects working on the theme.

Besides laying a basis for the next step Analysis and Design proposal, learning about what is being done in architecture today to address the common issue of global housing crisis has helped to find answers to the four issues diagnosed in the first part. The **Cost factor** will be addressed through an **Integrative approach**, the **Time factor** through a **Modular approach**, the **Ecology factor** through a **Vernacular approach** and finally the **Culture factor** through an **Integrated design approach**. The construction techniques to be retained for

further analysis are the *Bamboo Modular System*, *EcoCocon* and *Cortex shelter*, in relation to local availability and structural performance. The practicality of *U-Build*, thermal performance of **earth mixtures**, and **flexibility of space** of Bilbao's social house are also key elements to implement in the design proposal.



ANALYSIS AND DESIGN PROPOSALS

A. ANALYSIS

1. SWOT analysis
2. Interviews
3. Survey
4. Atlas of Materials

B. DESIGN PROPOSAL

1. Mind map
2. The final layout
3. The modules
4. The structure
5. The finish
6. Cost Estimate

In light of the previously mentioned architectural and building approaches and their comparison to the local setting, this chapter investigates more thoroughly whether a modular-vernacular model can be implemented for architecture and low-cost housing schemes in the island. The methodology used are presented together with the outcome in the following order: a SWOT Analysis to diagnose the strong and weak points of the project to focus on; interviews and survey to collect data and opinions on the subject; and an Atlas of Materials to list the materials available on the market and their price. The second section presents the rest of the methods more centered on the design proposal: a CAD design concept for the social home; two Construction method proposals and small-scale model experiments to test their constructability; and finally, a Cost Estimate for each proposal.

A. ANALYSIS

1. SWOT analysis

SWOT analysis is a common project management tool used to evaluate the Strengths, Weaknesses, Opportunities and Threats of a project. It was chosen specifically for its critical method of exploring the project's own qualities and downsides, and all outer elements that can positively or negatively impact on the project's implementation. The analysis results are shown in the table below.

The strengths are quite similar to the advantages of modular architecture enumerated in chapter 1. (I.B.1.c) The main weakness was the fact that technical assistance such as engineers will be required to supervise the proper assembling of the modular building. But this is the case for any construction due to safety reasons. Thus, the weaknesses are largely outweighed by the advantages.

However the threats should be seriously considered. The main challenges facing innovative construction technologies is the tempestuous climate and people's reluctance to choose other materials than concrete justified by past experiences. There is also a strict control over materials by the local authorities (as for many countries like Shigeru Ban explains (McQuaid, 2006)), because the building safety

and thus citizen safety falls directly under their responsibility, especially in the social housing sector

Common misconceptions about green materials to deter their use, for example straw is regarded as a poor material by some while it is used in hotels and villas for a rustic look. Thus, public opinion on materials is diverse and should be verified by a survey and interviews.

Yet, the opportunities are numerous. As a small island developing state, Mauritius encourages innovations, such as for green prefabrication technologies. Focusing on a small-scale project for the social housing field is suitable for a start and helps to set an example. This can encourage bigger projects and more actors adopting these building methods. Furthermore, as mentioned in Chapter 1, module-production process mobilizes a team or community, hence opening job opportunities for many. These suppositions now have to be verified in this chapter and will again be discussed in the last chapter.

STRENGTHS Incremental, adaptability, flexibility, reduced time-cost-carbon footprint	WEAKNESS Still require technical assistance for structure, material procurement, ...
OPPORTUNITIES Welfare state, Mauritian's Participative culture, Market demand, Prefab knowledge and applications	THREATS Climatic risks, Negative public reaction or reluctance, Inflation of prices if demand gets higher

2. Interviews

The SWOT analysis helped to understand which areas to make deeper investigation and both formal and informal interview methods were chosen for the purpose. Firstly, it was imperative to interview three professionals in the construction sector who are active in the social housing field: an architect, an NHDC officer and an NGO officer. They are the ones who know enough about the living conditions, financial struggles, needs and feedback of inhabitants, so as to advise on the feasibility of such a modular-vernacular social project. Secondly, other less formal but more material-specific interviews were carried out with specialists working with clay, earth and bamboo. These were done at the same time when experiments were being done, which will figure later in this chapter itself.

The persons interviewed are listed here and full excerpts can be found in the Annex.

- **Local Architect, Bunjun Architects Ltd**
Dharam Dev Bunjun
- **Local Government Officer, NHDC Ltd**
Satyam Ramma
- **Local NGO Officer, Caritas Mauritius**
Cursley Goindoorajoo
- **Local Clay Artist, Ananta Art Gallery**
Mr Devanand Bungshee
- **Earth Construction specialist, Engineer and Researcher, CRENAU**
Marta Miranda
- **Bamboo Specialist and Architect, Bambulenat**
Fatima Martin Alvaro

The outcome of the interviews can be described as:

A common concern was seen about the durability of any new construction methods proposed. However, after this remark, the research work was encouraged as most interviewees seemed to agree on the ecological opportunities that these could represent and the positive impacts on the well-being of the residents.

Another common conclusion between conversations with Bungshee and Bunjun is that people do not construct in other materials because of the scarcity or absence of local materials, explaining the exorbitant costs of imported wood, bricks, etc. They also related this to the absence of skills associated with other construction methods, such as brick-making, or bamboo assembling. Similar thoughts were shared by the bamboo specialist Martin, but she trusts that modularity may help curb this problem, provided buildings can be certified hurricane-resistant like Bamboo Living houses in Hawaii.

Both Bungshee and Miranda elaborated on the positive qualities of earth as a construction material. Miranda encouraged combining the use of earth with straw, bamboo and jute, but making an “earth fabric” was difficult to imagine due to the brittleness of earth, for instance with current technology.

As for the integrative approach, Bunjun and Cursley both affirmed that there are still Mauritians who like to involve in the construction of their house or their relatives when they have the opportunity to, in memory of traditional community building. All these opinions now have to be put up against the general public opinions, which can be collected in a survey.

3. Survey

The survey was carried out on a sample of 100 Mauritian citizens so as to gather information about the actual house construction methods and people's thoughts about them, along with their opinions on modular building techniques and their application in social housing. The survey included questions about their own house, its age, whether they participated in building it or not, which materials was used or they would prefer to use and what would the house become if they were to leave. Then after a brief introduction to modular architecture, a few more questions on whether they considered it a good option and which among the types described they found the most interesting. The results of the survey are summarized here.

Among the 100 participants, 95 are adults. 50 are professionals, while the rest are either students, unemployed or retired.

A Mauritian architecture survey
 Hi Mauritian friend!
 I am Khushboo Beekawoo, student from Nantes School of Architecture (ENSA Nantes-Mauritius).
 This survey forms part of my Master Thesis research project to discover if our island can adopt a new, more sustainable construction method, which can help the social housing sector.
 In Mauritius, many people do not own a proper house and live in poor conditions. With construction costs getting higher and natural disasters becoming more frequent, even the numerous social housing campaigns, both by the public and private sector, are finding it hard to provide a concrete house to each family in need.
 This is why I am making a census / collecting your opinions about the actual construction methods in Mauritius and the new eco-friendly materials to be considered.
 Thank you for precious time and help!
 *Required

About you

1. Age *
 Mark only one oval.
 below 18
 18-50
 above 50

2. Profession *
 Mark only one oval.
 Student
 Working
 Other: _____

3. Profession / Study field *
 Mark only one oval.
 Architecture/Construction field
 Other: _____

About your house

Excerpt of the survey prepared through Google Forms. The full survey and results can be found in the Annex.

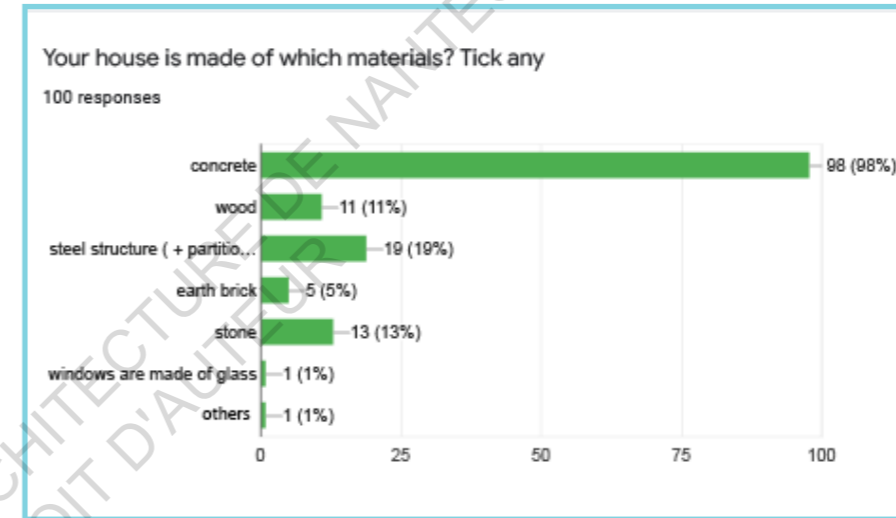

Nearly all participants' houses are made of concrete, but about half did not know that the construction industry produced 38% of CO2 emissions. Also 46% have no idea of what will happen to their house if ever they have to move out, which shows that building redundancy is a real concern worldwide, which is not often discussed while it should be part of the key considerations during design phase.

Although only 45% are in the construction field, the responses and comments received show the keen interest of Mauritians in general in the subject of green building. They were all sensitive to greener materials and among the ones proposed, greener concrete, wood and natural materials were the most preferred, followed by earth bricks, steel structure, recycled materials and container house.

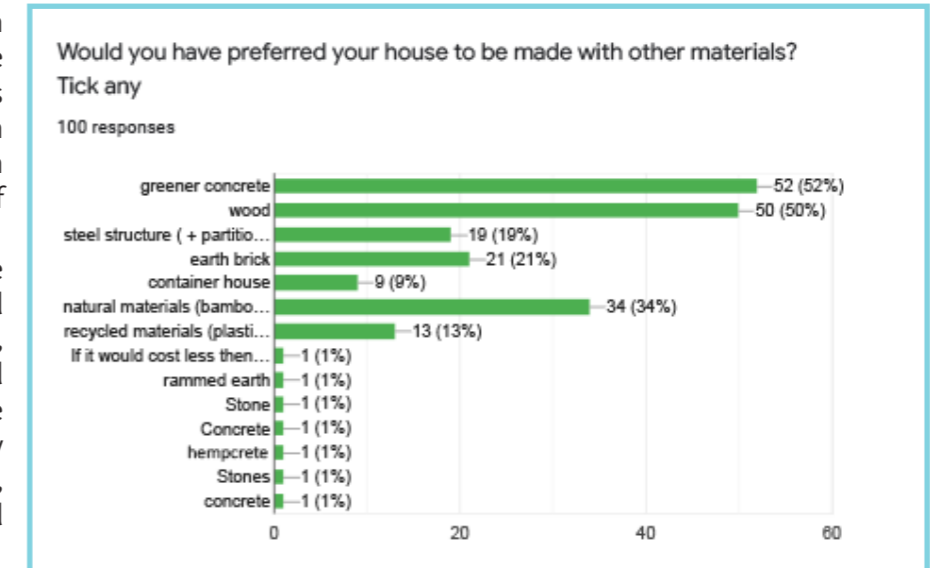

Thirdly, a tight match was observed between modular and traditional construction, showing that modular architecture is a considerable option for the population and thus has a scope in Mauritius. 87% are optimistic about the help modular architecture can bring to the social housing sector.

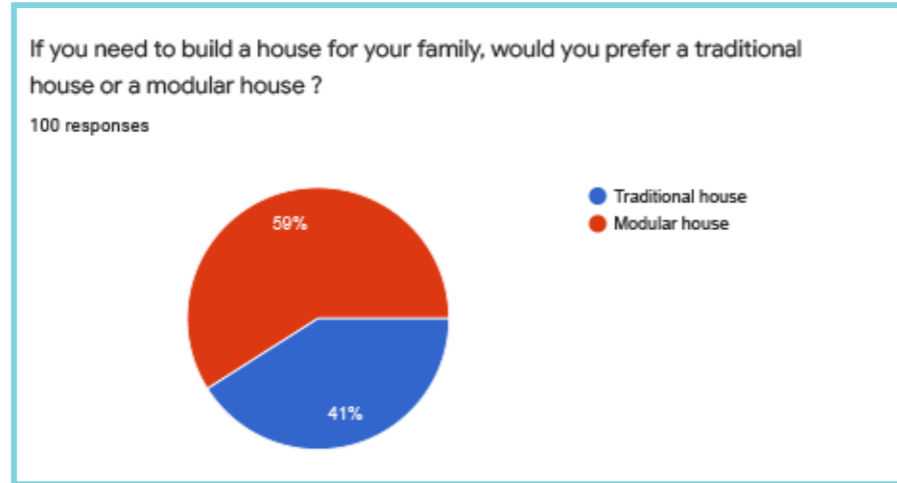

Finally, there were many positive feedback and advice from participants, but some apprehension too, especially about the storm resistance of modular buildings, as seen during the SWOT Analysis and Interviews. Other concerns were namely about costs including labour cost; performance with respect to climate and high humidity; durability, energy consumption, and the architectural identity of Mauritius.

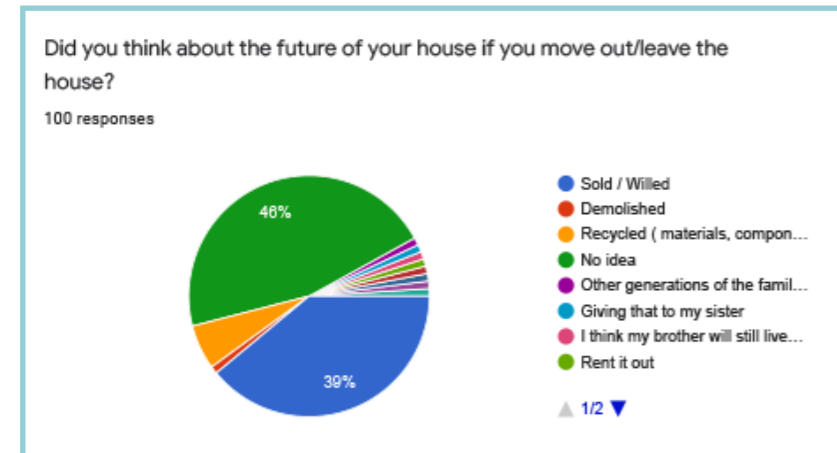

Another observation is that the participative culture of building together is truly still present in the population as seen in literature and interviews. Most participants who did not get the opportunity to participate in their house construction would have liked to. Additionally, the general preference for Community-based workshop shows that a collective process interests people more than building alone, even though the options of assisted self-build and prefabricated house also got many votes for their practicality.

Any comments or suggestions

27 responses

Modular design means all houses are going to be custom made but have the same aesthetic . I believe that the mauritian landscape needs to me as it has always been. An amalgamation of several cultures showing the mixity.

Consider the weather of Mauritius, its high humidity

Modular construction a a good idea depending on the costs it will take .if its cheaper and reliable like concrete.

As we do not get hurrrycanes and big cyclone, so mauritius do not need heavy duty houses.

Thank you for this survey, it's important to have such discussions in Mauritius. I just hope that the state through the ministry of public infrastructure and the ministry of land/housing realise that we're already at the tipping point. Climate change is happening and the construction industry is a big contributor. I hope they also democratise the offer of design tenders, so that better and more adaptable ideas can surface.

I think house must built with cheapest material

4. Atlas of Materials

After the problem diagnosis, design approach research, experts' advice and public opinion collection, the remaining step before a design proposal and conclusive material choice is the price finding. An intricate investigation was carried out on the adequate materials available on the local market and trade market, and their cost. These are combined in an Atlas of Materials shown in the next page, with a similar classification of materials as the Inventory (*I.B.1.e*), except unfolding structures and recycled materials were omitted for availability reasons.

First-hand data was collected from professionals and companies in the construction sector including local construction suppliers or 'Chantiers', interior fitting companies (*Yed-Tholsiah Limited*), and craftsmen for the local market. For materials on the international market, data was gathered from official documents like *Delhi Schedule of Rates* or market studies (*CCM, 2018*) and official e-tailing market including *Amazon* and *IndiaMart* because India is among the trading partners of Mauritius. The building techniques previously mentioned in the Inventory were not all cited with their construction cost as these were either not available or inaccurate. Therefore, to complete the atlas, some of the price estimates are calculated based on these verified sources.

Imports freight logistics for materials like brick or the cost involved to make a container house were also investigated with the help of a Freight officer from the company *Velogic*.

The Atlas allowed to verify that:

- wood is an imported resource, thus expensive as compared to concrete. A wooden building is normally 60% more expensive than a concrete building in Mauritius. But wood lumber are easily found in the market as they are used for making concrete shuttering. Carpentry is a local know-how and should be more encouraged.

- bamboo in India is very cheap and it can be the case of Mauritius too if it is cultivated. It can become a widely-used construction material, affordable to all.

- earth is also a luring option since *Malaysian Interlocking Bricks* are the most affordable of the list. These can also be imported without exorbitant imports freight or MUR 100,000 per 20ft-container (*Velogic*). However, it cannot be considered vernacular since it is not a local material. The process of importing a new material is energy-consuming and carbon-emitting and thus defeats the purpose of the project. It would be similar to importing concrete blocks.

- conventional concrete construction can be substituted by concrete fabric for walls and roof, as long as the *Cortex Shelter* system stays at the reasonable price it has been quoted. Else, concrete roll on its own is currently too expensive.

- prefabricated structure like containers are not surprisingly fairly cheap since sea trade is common for an island in the middle of the Indian Ocean. Nevertheless, their poor thermal performance is not adapted to tropical climates and will eventually impact on the lifetime costs, together with the maintenance. Steel is more versatile and completely modular but its high price makes it suitable for bigger structures rather than small houses.

- straw as a finish material is expensive because there is only a limited amount of craftspeople in the field and they are mostly approached by hotel investors. However, it stays an inexpensive natural alternative to other insulation materials.

This atlas is the most important part of the research as it will be used for the Cost Analysis of the project proposals. Moreover, it has also guided the two final material choices: bamboo and wood, for the structure, with three finish options: earth, bamboo or thatch. These will be compared to a concrete option too.

UBP BLOCKS



AMERICAN BLOCKS



AAC BLOCKS



FIBRE CEMENT BOARD

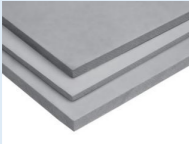

GYPSUM BOARD



FOAM



FIBREGLASS



ATLAS OF MATERIALS

	UNIT COST (MUR)	WALL COST (MUR/m ²)	HOUSE COST (MUR/m ²)	SOURCE
WOOD				
SOLID WOOD BOARD Meranti		4750		Yed-Tholsiah Limited
PLYWOOD 12mm	374	2750		Yed-Tholsiah Limited Delhi Schedule of rates 2020
MDF BOARD 12mm	247			Delhi Schedule of rates 2020
OSB BOARD	322			Delhi Schedule of rates 2020
LUMBER Meranti 25x50mm Balau 75x75 mm Balau 75x100 mm Balau 100x100mm	48 /m 427 /m 410 /m 500 /m			Chantier Plaisance, MU
PLANK Balau 25x200 mm 50x200 mm	413 /m 427 /m			
BRIKAWOOD	200	13000	55000	Chantier Plaisance, MU brikawood-ecologie.fr brique-bois.com
U-BUILD			53000	u-build.org
BAMBOO				
BAMBOO ROD (100 mm) Dowel (8 mm) Coir rope (5 mm) BAMBOO PANEL	6 /m 30 /m 7 /m		350	India Mart vts-hobby.fr Amazon
EARTH				
INTERLOCKING BRICKS		20	3300	myib.com.my
CONCRETE				
CAST-IN-PLACE CONCRETE Steel Reinforcement Cement (25kg: MUR 150) Lime (25 kg: MUR 775)	4500 /m ³ 56 /kg 6 /kg 31 /kg			Local Market

UBP BLOCKS	25	300	16000 - 20000	ubp.mu
AMERICAN BLOCKS	120	1440		boutique.teralta-audem.ard.com
AAC BLOCKS	50	450		aircrete.com
CONCRETE ROLL		1525		wrap.org.uk
CORTEX SHELTER		2335	7167	cutworkstudio.com
PREFAB STRUCTURE				
STRUCTURAL INSULATED PANEL		700	12850	Delhi Schedule of rates 2020 sip-energy.com
ALUMINIUM PARTITION		4500		Yed-Tholsiah Limited
GYPSUM BOARD (12.5mm)		91		Delhi Schedule of rates 2020
FIBRE CEMENT BOARD (8mm)		118		Delhi Schedule of rates 2020
STEEL TUBE (Galvanised 1.5mm) -25x25 mm -25x38 mm -50x75 mm		170 190 390		Chantier Plaisance, MU
STEEL PLATE (3 mm)		1771 /m ²		
BOLT & NUT (6x120 mm)		2		
SCREWS (20mm)		0.5		
CONTAINER HOUSE -20ft -40ft		70 000 90 000	7000	Velogic Mauritius defimedia.info archdaily.com
STRAW				
THATCH HOUSE Walls Roof Walls+Roof+Labour		350 650 950	12500 (pine log structure)	Local craftsmen
STRAW BALE HOUSE	150 /m ³	1836	5400 - 8500	feedcentral.com.au (Yin, 2018) (Marks, 2005)
ECOCOCON			19600	ecococon.eu
OPENINGS				
ALUMINIUM FRAME	4500/m ²			Delhi Schedule of rates 2020
WOOD FRAME	2700 /m ²			India Mart
INSULATION				
FIBREGLASS		242		Delhi Schedule of rates 2020
FOAM		832		Delhi Schedule of rates 2020
JUTE (roll)	12 /m ²			India Mart

ALUMINIUM PARTITION



SIP

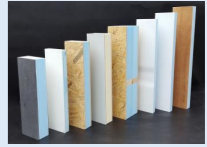

PLYWOOD



WOOD LUMBER

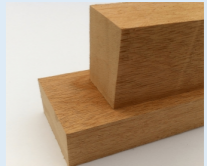

SOLID WOOD (MERANTI)



OSB



MDF



B. DESIGN PROPOSAL

Based on gathered information from analysis, a final design for the modular-vernacular project is presented in this section, together with the mind map and experiments that helped to its development, and also the two material proposals of bamboo and wood, with their respective cost estimations.

1. Mind map

Brainstorming was done to determine the key elements to implement in the project, and common principles were highlighted, as presented in the mind map diagram below.

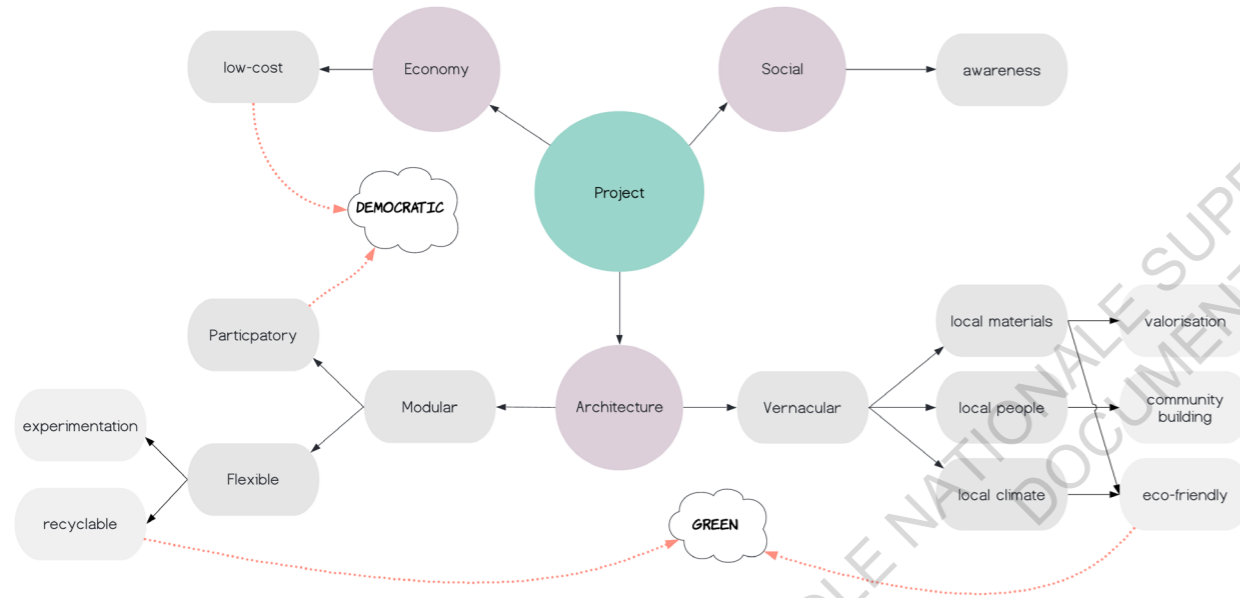

SUSTAINABLE

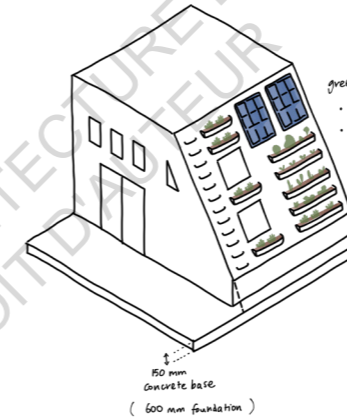

COMFORTABLE

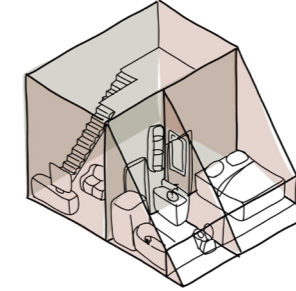

INCREMENTAL

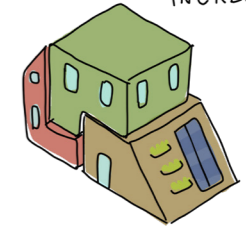

PLOT COVERAGE = 49 m²
 TOTAL SURFACE AREA = 160 m²
 - WALLS & ROOF = 146 m²
 - OPENINGS = 14 m²
 325 modules
 + 80 half modules

2. The final layout

The concept was drafted using paper and digital means, until reaching a conclusive design. The final layout was then drawn using AutoCAD 2020, as shown in the next page.

A slanted facade gives an aerodynamic shape to the overall building to redirect winds, while being at the same time a green wall with planting trays and solar panels. Different components can be chosen by the inhabitants themselves for this facade, similar to Precht's *Farmhouse* project. (I.B.1.e)

The flexibility of the design also lies in the front terrace which is sufficiently large to accommodate a small business, as in Bilbao's social houses in Mexico. (I.B.2) Different possibilities of configurations and extension can be foreseen too.

The final layout for the DIY social home on Autocad 2020.

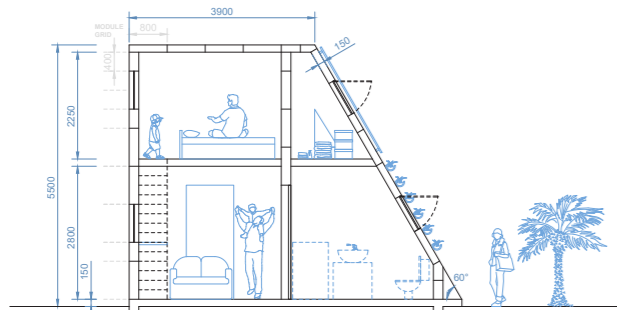

Structure and ventilation of living spaces and bathroom

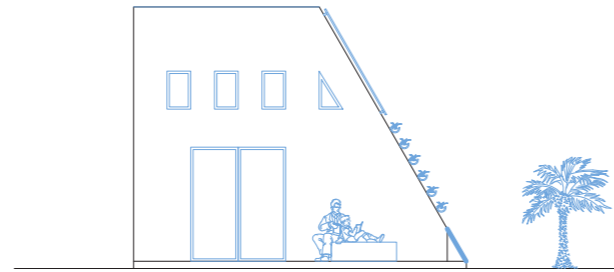

Aerodynamic form with gardening facade and flexible outdoor space

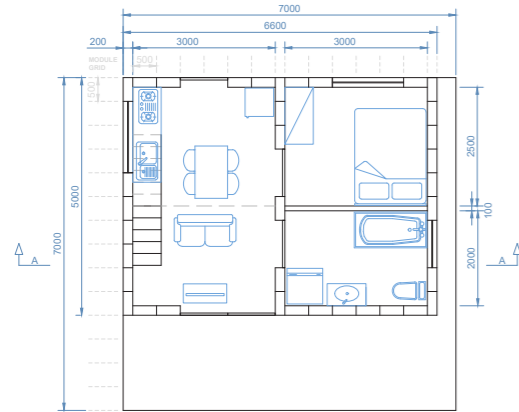

Common spaces in a free plan on ground level

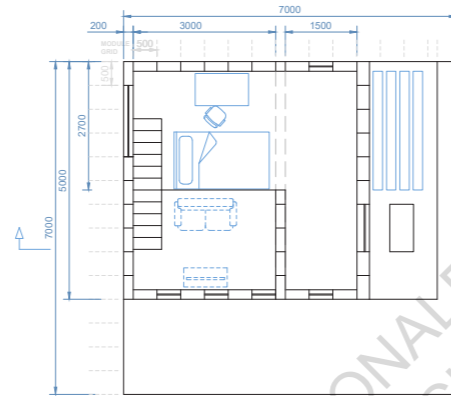

Mezzanine for children's space and storage

3. The modules

One module size is thus 0.5m wide, 0.2m thick and 0.8m high. This size was decided for ergonomic reasons, it is practical and light enough to be easily transported, while being large enough to fill in the wall area quickly. Some half-module of 0.5x0.4m are also required in specific parts, for instance in the first row to allow for a staggered arrangement of the full modules, hence creating a monolithic assembly. The half-module is in fact more practical than the normal module, but

was not the preferred choice as it requires more material to fill in the same wall area.

The concept is a community-based workshop for the production of the modules on-site: the inhabitants themselves assemble the module, wrap it in a jute envelope, and add the straw infill insulation.

Details on how to assemble the modules differ from one material to the other. Therefore, construction details are rather described and illustrated separately for each proposal in the next section.

the concept of circular economy in the project, with the community-based workshop for module production, and life cycle phases of the building

CIRCULAR ECONOMY

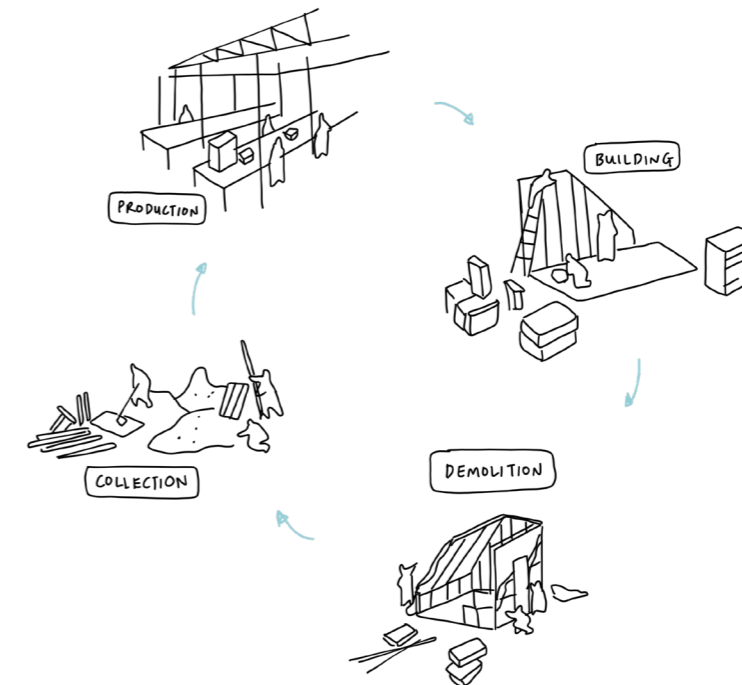

4. The structure

Structure proposal 1: Bamboo

This main proposal with primary use of bamboo has been chosen in the scenario where bamboo is being cultivated in Mauritius. The main challenge of using bamboo was to use the appropriate joint, which has to be easily made and used, relatively cheap and provide enough strength to the structure to resist cyclonic winds of 280 km/h. What makes this bamboo construction “easy”? In addition to the modular joints presented previously in the Inventory (*I.B.1.e*), traditional joints for both bamboo and paper tube constructions were studied and some were tested.

Finally, the chosen joints, as shown in the axonometric drawing, are the traditional fish-mouth joint, with dowels and rope (coco fibre or rattan also works (*Julistiono et al., 2014*); plug-in joint of wood between the modules, pine and plywood were chosen due to their availability, lower cost, lightness and maneuverability; and anchor joint of steel plate and tube for the ground anchoring. These can be spaced, while intermediate modules are held together at each one meter with additional bamboo bracing and lashing. As for the openings, they are supported by wooden frames, easily bolted to the bamboo poles.

The difference with the Bamboo Modular System shown in the inventory (*I.B.1.e*) is that here, the modules are independent, including fixed and flexible parts. The fact of purposely shifting the horizontal elements joints away from the vertical joints distributes the forces that would otherwise converge at a single joint. It also ensures a vertical continuity between each module, making the series of stacked modules behave as real bamboo poles.

More bamboo rods as linear bracing can be added for additional support.

The bamboo structure proposal and modular joints chosen for easy assembling.

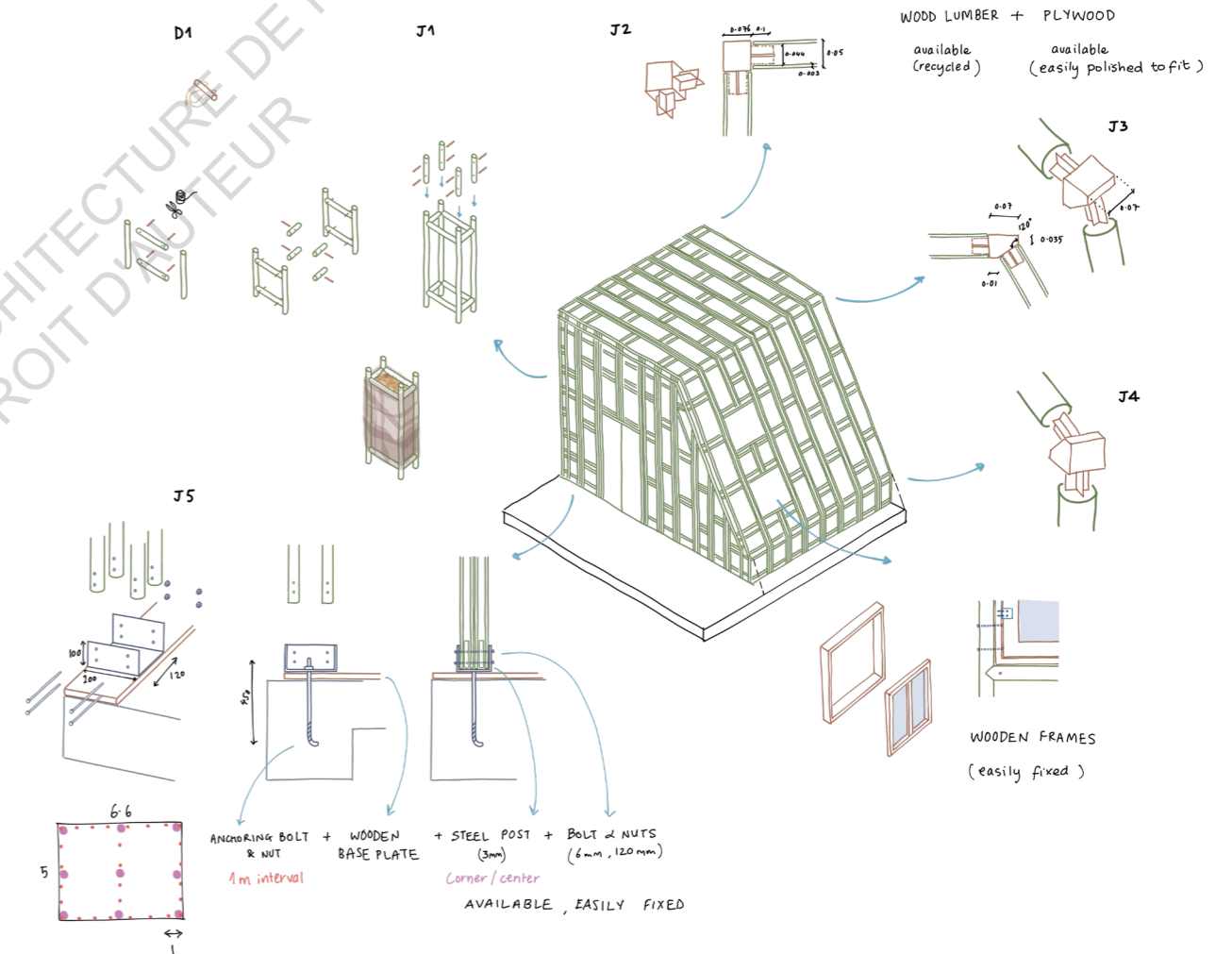

The fish mouth or lateral joint was tested through small prototypes. It was preferred over cross joints to prevent multiple perforation of the vertical elements, that would weaken the structure. (Schröder, 2009)

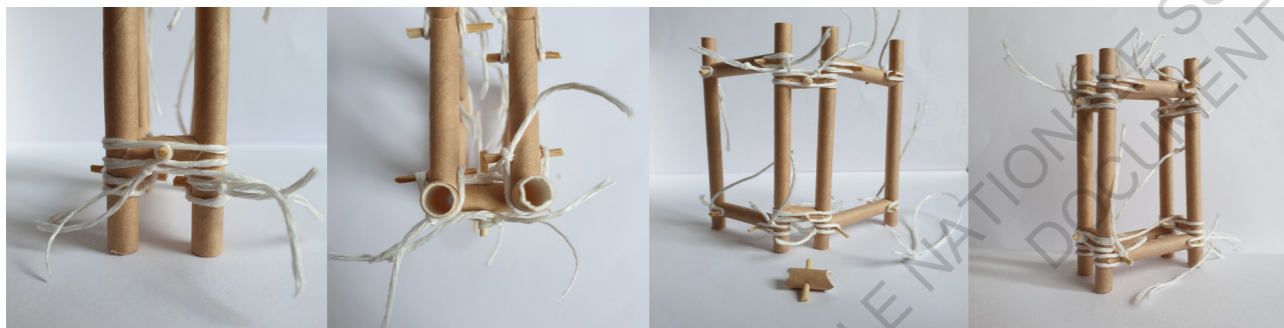
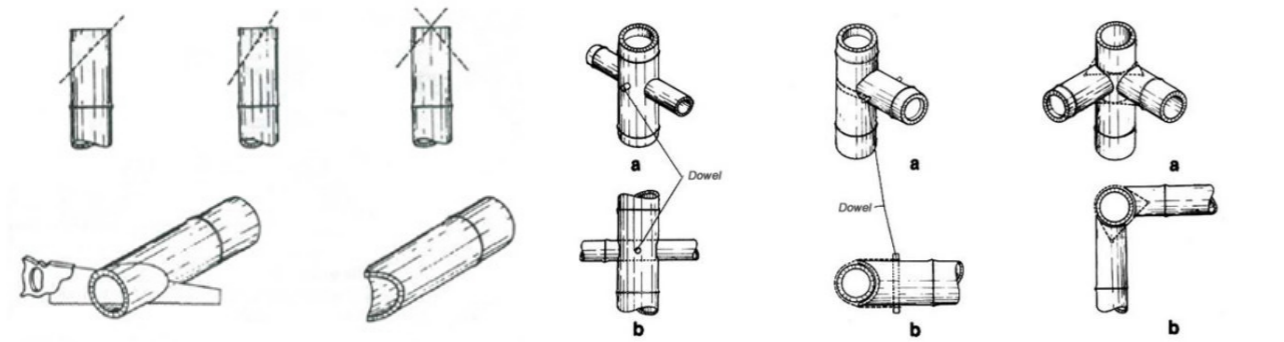

Wooden plug-in joints used for paper tubes in angled corner (Shigeru Ban Architects), roof truss (likemyplace.wordpress.com) inspired the plywood joint.

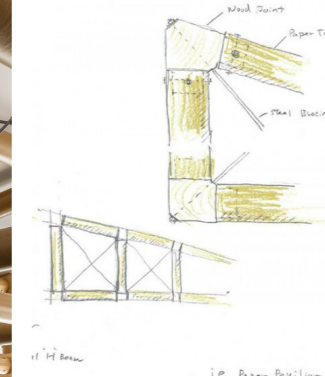

Steel plate joints are versatile and suitable for ground anchoring of bamboo poles like in the Bamboo Garden by Atelier REP (archdaily.com). Wooden anchors can also be used as shown in the paper tube structure (clarewashington.wordpress.com) Anchoring bolts were chosen to hold wooden base plate and anchor posts (renovation-headquarters.com)

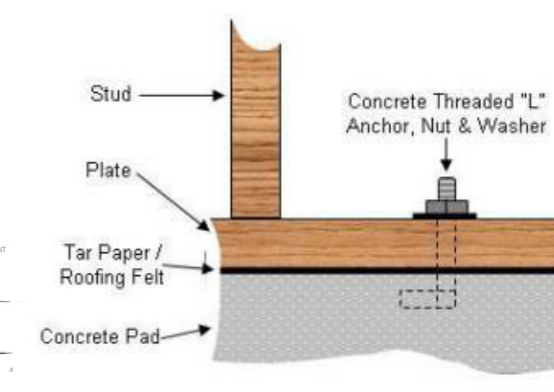
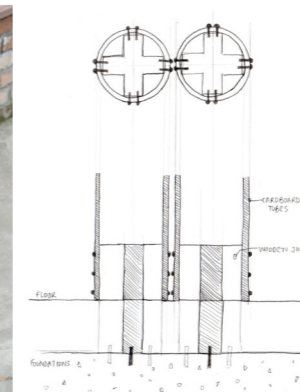

Structure proposal 2: Wood

As concluded in the atlas, wood lumber are a frequently used material on concrete construction sites and the carpenters needed for it are present, although in small numbers. The idea is thus to use a simple technique to make wooden modules and assemble the house in the easiest way possible without skilled labour, while ensuring the structural strength.

The main reference here is the EcoCocon panel from in the Inventory (I.B.1.e) with minor differences. It uses the same system as the Bamboo proposal. The straw filled panels are interlocked rather than screwed or bolted, in the same way of Brikawood or Lego, to prevent weakening the wood. Meranti lumber was chosen as it is strong and available in different size. It is complemented with plywood at joints, which is less expensive and also readily available.

Modules are fixed to the wooden base plate with screws, without the need for steel plates. At mezzanine and roof level, additional bracing beams that also go down the walls are required to distribute the load efficiently to the ground. The joints were more complex than for the bamboo because interlocking cannot be done without screws when using lumber. Glue also is normally used to strengthen lumber structures but was not used in this proposal.

Again, some models were made to understand the mechanism better. An unfolding mechanism module was tested, but its purpose would have been interesting in the case of a flat-pack house that is built somewhere else and has to be transported on site. Here the modules are being produced on the site itself, so a flat-pack is not so useful.

The wood structure proposal and modular joints chosen for easy assembling.

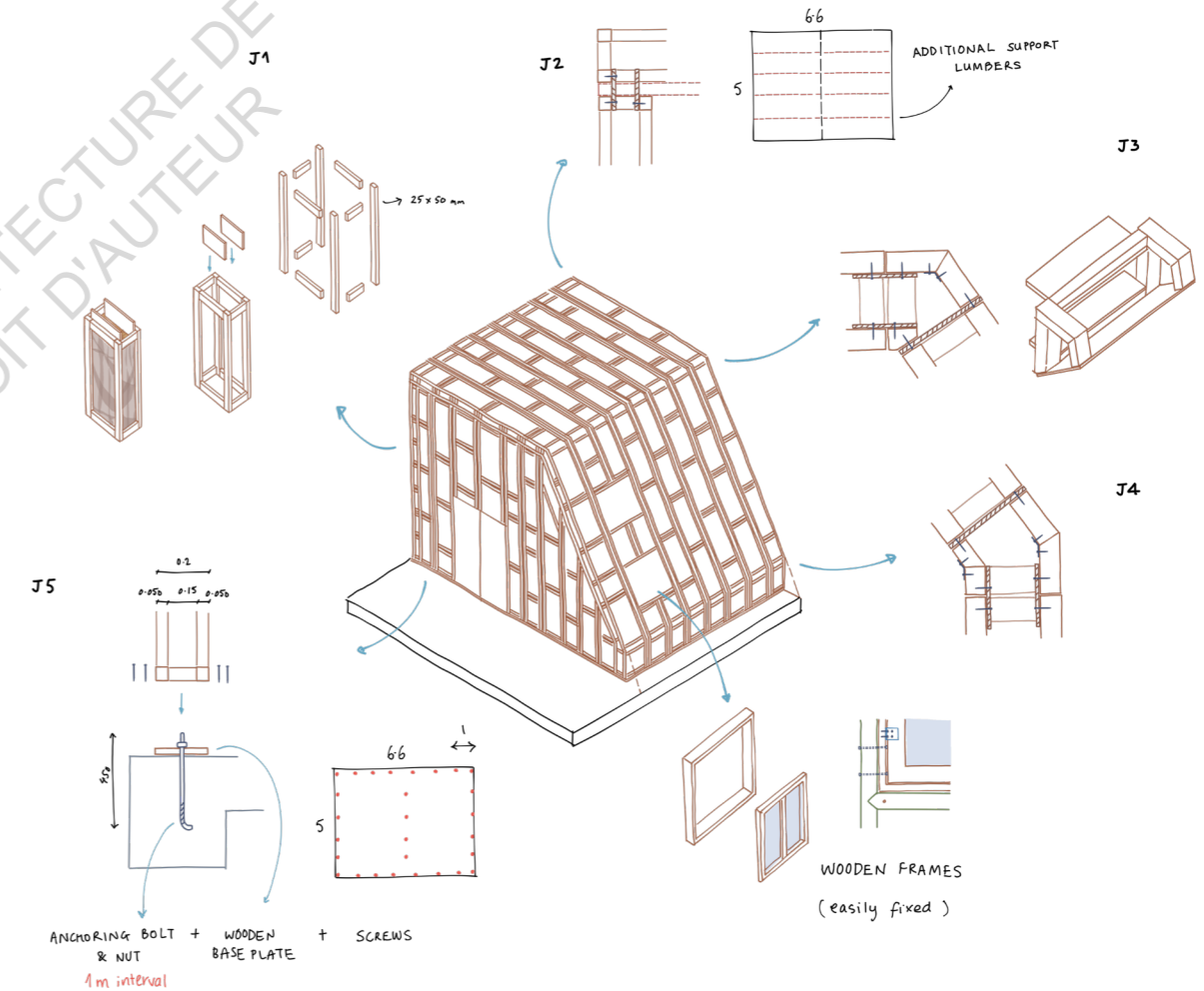

A few module models were made to test which technique works best, with unfolding mechanism inspired from origami.

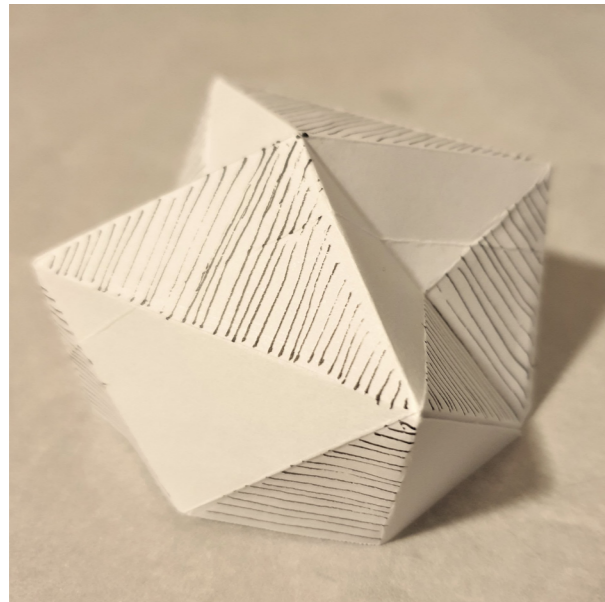
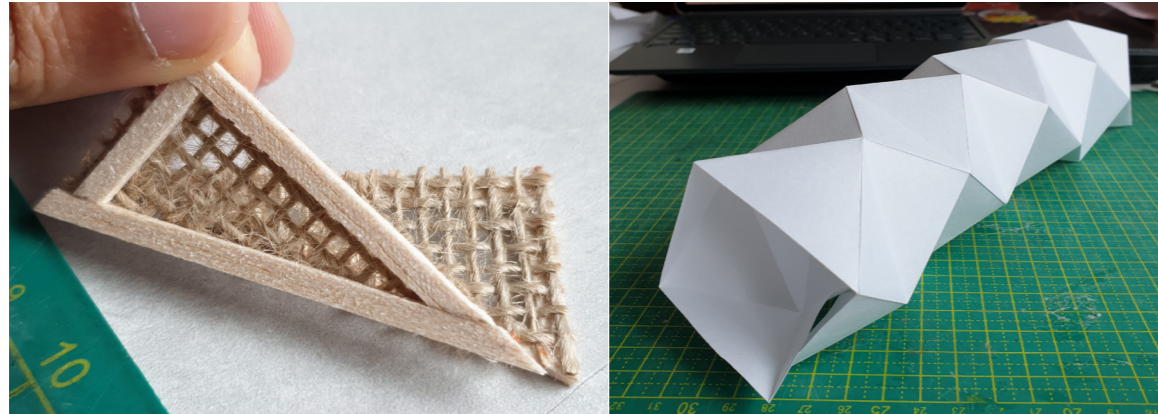

5. The finish



Material proposal 1: Earth

The jute envelope of the modules is a great surface to grip plaster, here an earth mixture. This is made with on-site excavated soil, cow-dung and a natural stabilizer such as lime. Once dry, the building is very strong, with good insulation and thermal properties.

The Bamboo-Clay combination was the subject of an experiment during a university workshop with the Earth specialist, Marta Miranda. Together with classmates Navneesh Ramessur and Oudish Appadoo, two scale models were made, one with split bamboo structure and the second with Vetiver, a popular plant in Mauritius. Both were plastered with earth-cowdung mixture and a finish with lime. They were both very solid structures and behaved well with water droplets,

by either absorbing it or repelling it, without letting it pierce through. This workshop proved to be very enriching for both personal knowledge and for this thesis.

The proportions needed of earth to dung to water are approximately 2:1:1 with a little amount of lime. This option is the cheapest among the 3 finish proposals, because mostly waste materials are involved. Labour costs also are not to be counted since it is a simple process, manageable by the inhabitants themselves. Only lime cost and transports cost have to be evaluated.

These experiments of a jute-earth combination can be related to the aforementioned “**earth fabric**” (I.B.1.e) and in the interview with Miranda. Using a natural material as earth in the innovative *Cortex Composite* technology instead of concrete, is worth a study in a future research.

Two model experiments for a lightweight earth building or "Habitat Leger": a dome-like Bamboo-jute structure and an arched Vetiver bundles and lattice structure inspired from Mudhifs in Iraq.



Material proposal 2: Bamboo

Bamboo's versatility makes it a resistant and beautiful finish material. Woven mats, split bamboo panels, lattice panels and shingles are known options for interior and exterior of walls. Bamboo lattice is quite similar to rattan lattice which forms part of the local crafts, and can be used to make thinner earth partitions. But here, only a simple bamboo panel was chosen, similar to those in the bamboo house of H&P Architects. (I.B.1.e)

Bamboo panels in bamboo house by H&P Architects. (floornature.com)

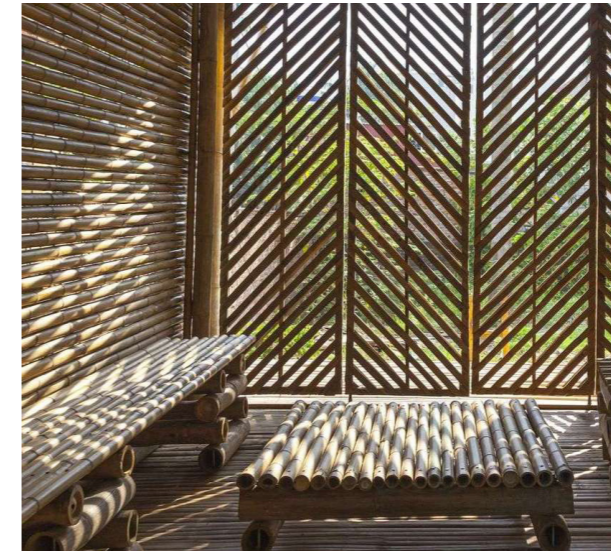

Material proposal 3: Straw

Thatched houses will provide a very cool atmosphere inside while being rain-proof outside, just like the huts at Le Morne Replica Village. (I.B.1.e)



Thatched hut at Le Morne Replica Village made by local craftsmen. (Site visit during internship, 2020)

6. Cost Estimate

The overall cost for each proposal has been estimated with the different finish options. This required detailed calculations through a breakdown of each building component and materials and use of formulas as shown by an example below (full cost analysis in Annex), while the results obtained are tabulated as show besides.

Bamboo Structure Proposal	= Reinforced Concrete Base	+ Wooden Base plate	+ Modules	+ Joints	+ Additional bracing	+ Openings
	= 58600	+ 11150	+ 63120	+ 17325	+ 10800	+ 49680
	= MUR 210,668					
Module Price	= bamboo + dowel + lashing rope + jute + straw					
Module	= MUR 166					
Half Module	= MUR 144					

Wood Structure Proposal	= Reinforced Concrete Base	+ Wooden Base plate	+ Modules	+ Joints	+ Additional bracing	+ Openings
	= 58600	+ 11150	+ 252,290	+ 6930	+ 5840	+ 49680
	= MUR 387,520					
Module Price	= lumber+ plywood + screws + jute + straw					
Module	= MUR 625					
Half Module	= MUR 613					

PROJECT ROPOSALS COST ESTIMATE			
Structure (price in MUR)	Finish (price in MUR)	Total Cost (MUR) including Labour, Transport and Contingencies	Total Cost (€) including Labour, Transport and Contingencies
Bamboo = 210,668	Earth = 46,325	351,600	7090
	Bamboo = 149,025	465,700	9390
	Thatch = 149,025	465,700	9390
Wood = 387,520	Earth = 46,325	590,600	11,900
	Bamboo = 149,025	707,800	14,240
	Thatch = 149,025	707,800	14,240
Concrete = 600,000	Rendering, Painting, Tiling	800,000	16,130

Conclusion

This chapter has described the methodology used for a deeper analysis of the local context, through an investigation of local resources or locally-available resources, and consultation of local people, local experts and businesses. International expertise and references consulted were also exposed. The second section has detailed the design proposals and weighed them against thorough costs analysis with realistic figures of investments needed. The results and the project as a whole are evaluated in the next chapter.



DISCUSSION & EVALUATION

1. Is the project viable?
 - a. Cost
 - b. Public acceptance
 - c. Local climate
 - d. Constructability
 - e. Local resources
 - f. Durability and maintenance

2. How far have the social housing issues been tackled?
 - a. Cost factor: Integrative approach
 - b. Time factor: Modular approach
 - c. Ecology factor: Vernacular approach
 - d. Culture factor: Integrated design approach

3. Other advantages
4. Possible improvements

This chapter presents an in-depth critique of the project and data gathered through methodology. The project's viability is discussed first, followed by how far it responded to the issues pinpointed in the first chapter. (I.A.2) The overall benefits and ways to improve the project are also discussed.

1. Is the project viable?

So as to evaluate the project, the viability criteria described in the introduction have been hereby can thus be answered as follows:

a. Cost

- Will such a modular building cost less than traditional concrete building?

Yes. Bamboo structure is the most affordable option, being nearly three times cheaper than concrete structure, followed by wood structure, showing modular technology indeed reduces construction costs. This is also helped by the vernacular approach, because bamboo was considered a locally-cultivated resource. The wood proposal cost lower than concrete because it was only used for structure. Else, the wood house would normally cost 60% more than the concrete house, or MUR 1.28 million (€ 25,800).

Earth is indeed the cheapest material for finish, with only a little investment needed for lime. Thatch and Bamboo finish are around the same cost when made by professionals.

These cost estimates include around 25% of labour costs which will be reduced through the self-construction with low technical assistance needed.

b. Public acceptance

- Will local citizens approve of such a modular construction method, when for them a concrete house represents a safe habitat and a pride?

Yes. At first, public reluctance was identified as a potential threat to the project in the SWOT analysis. But a survey was carried out and it was concluded that modular architecture interests the public and is acknowledged as being a potential solution for low-cost housing in Mauritius. Many participants were cautious about the cyclonic resistance, as were the interviewees.

Nevertheless, the latter, who were all professionals from either construction sector or social housing or material experts, encouraged research on the subject. Thus, it can be concluded to be a promising path.

c. Local climate

- Does modularity compromise the strength of a structure for natural materials or can it resist cyclones?

This mainly depends on the design of the house. With proper joints, the structure is resistant.

In this project, knowledge of key elements needed for cyclone-adapted structures was applied and implemented in the design: the aerodynamic form of the house and concrete foundation.

Secondly, an intermediate point between monolithic and modular architecture was found through staggering of modules and interlocking systems, rendering the structure much stronger. Proper joints strengthen the structure, distribute the load evenly and make the modules behave like a monolithic building.

Wood and bamboo's structural properties are already proven by research. (I.B.1.e) Bamboo being flexible, it will not collapse like a concrete building would. As for the wood, if glue is used, the structure will be even stronger.

The project's cyclonic resistance is yet to be tested through simulations and laboratory tests.

d. Constructability

- Can modular construction help simplify building with natural materials for self-building?

Yes. Bamboo constructions are quite complex, wooden house are not so simple either to be build without a contractor's help. But literature review and references from the inventory showed how

modular buildings could be rapidly assembled, precisely because it is simpler and intuitive, and a few modular-vernacular building techniques were found. Experiments with scale models allowed to know which techniques were simple, although most were still complicated or fragile when it came to use of natural materials. But it was found that prefabrication really helped to simplify the construction of bamboo. Modularity brings bamboo buildings to a much more human scale. The same goes for wood. This is why the concrete fabric is revolutionary and can inspire an "earth fabric" or other new modular-vernacular techniques.

e. Local resources

- Which local materials are adapted for such a construction?

Bamboo, straw and earth were found to be the best adapted materials, since wood is an imported resource. Clay would have been best but interviews revealed that clay is a very limited resource due to the volcanic nature of Mauritius, with only rare clay pits like Balaclava. Therefore, earth can be used for non-structural purposes, and bamboo for structural purposes, provided it is cultivated more extensively and for construction. The first objective of the thesis of finding the best compromise material is hence achieved.

f. Durability and maintenance

- What is the lifespan of such a building and its maintenance cost?

Research proves that if well-designed and well-protected, bamboo houses can have a lifespan of 25 years (Bamboo Living), 30 years (Kaminski et al., 2016) or greater than 50 years. (Lo, 2019) Like every natural building material, wood and bamboo is prone to deteriorate quicker than usual due to insect attack, rot or humidity trapped in walls. In the project, measures taken to protect the structures from rain and water are the elevated base and the finish. For instance, earth plastering with lime and cow dung repels water, just like thatch. The bamboo and wood should also be treated to resist humidity and insects (Kaminski et al., 2016) Wood can be maintained through the application of linseed oil.

Even after use, the building can be disassembled to recover the wood for reuse; else both wood and bamboo are reversible, meaning they can be left in nature to decay, without the need for demolition.

2. How far have the social housing issues been tackled?

As specified at the end of Chapter 1, four different approaches were used to solve the issues diagnosed in the local social housing schemes.

a. Cost factor: Integrative approach

The current housing shortage exists due to the confrontation of a limited budget to a large target group of social housing applicants. However, through survey and interviews, it was concluded that if people are given the opportunity to be part of the project, they will be glad to construct their own house. The integrative approach results in drastic labour costs savings. When self-build systems are used, less materials and machines, thus less transport are required.

The rent for a low-cost housing is also very low. All these elements will help decrease, if not eliminate, the debt accumulated with rent backlogs. The second objective is thus attained.

b. Time factor: Modular approach

As described in Chapter 1, the main advantage of modular technology is rapid construction. Instead of waiting two years to be allocated a house or resolving to squatter state lands with no facilities, people can build the modular house proposed in less than 1 month. This is expected to be even quicker for larger communities as

more people will be involved in the module-production workshop. Thus, the fourth objective of “preventing people from building illegally, and promoting a respectful architecture” can be achieved.

c. Ecology factor: Vernacular approach

Using vernacular materials like bamboo, straw and earth contributes to a low carbon footprint, as they do not require much transport. The wood proposal too is greener than conventional concrete buildings. The only machines used are for cutting of materials, screwdrivers and lorries for concrete base. Except for the 12 m³ of reinforced concrete for base, with a possibility of substitution with recycled rubble; and screws and bolts which stay reusable, only natural materials were used, to enhance the energy-efficiency. The sustainability of the project also lies in the fostering of self-sustained agriculture and energy.

d. Culture factor: Integrated design approach

Integrated design principles such as thinking community spaces already exist in current social housing schemes. However, they are located far from developed regions. Through its flexibility and customized facades, the project proposed is more directed towards keeping the lifestyle and culture of the people who are used to living in Lakaz tol or corrugated iron sheet house. In addition to this, if budget savings allow for

region-wise development, people with current difficult living conditions will benefit from better housing facilities, without being evicted from their homeland. In other words, this approach contributes to the well-being of the residents in different ways. Another application of a holistic approach is the large terrace of the house, an extendable surface for people having small businesses, as in Bilbao's project. (I.B.1.e)

3. Other advantages

- Prefabrication of modules ensures a better control on quality, especially for the wood structure.
- Natural materials are favoured and no chemical substances are used, except for concrete in the foundation. Thus health-wise, the house can be said to be comparatively safer.
- The use of modular technology eases construction, with minimum training required at first. This enables low-income groups be self-reliant instead of being completely dependent on the state to build their home, which was the third objective.
- Personal satisfaction is achieved through self-building, which helps establish a stronger sense of belonging, on part of the inhabitants.
- The project brings on the upfront the underlying social imbalance issue of current “low-cost” housing schemes which can only be afforded by middle-income groups.
- A social housing, created from a green design will undoubtedly help forge the character and identity of Mauritius and project the image of a sustainability-driven developing state.

4. Possible improvements

The initial idea of the project of an eco-friendly DIY social house, when confronted against reality, was concluded to have more requirements than expected. Most have been previously mentioned multiple time but have to be summarized here, so as to open discussions for improvement.

- A concrete base foundation is necessary for cyclone resistance and rain protection. This accounts for a minimum cost of MUR 58,600. However, this can be covered by the government’s Slab Grant scheme. The total initial investment for a house will be hence reduced to MUR 287,200 (€ 5791) for the Bamboo-Earth option instead of MUR 351,600.
- Technical assistance by engineers is needed to supervise that the structures are safely assembled, with proper dimensions, joints, etc. This was identified as a weaknesses of the project in the SWOT Analysis but was also concluded to be an essential safety measure for all buildings.
- Training of residents in a workshop on how to prefabricate the modules, and then how to assemble them, can prove to be hectic for both the government and the people. It also depends on the sense of duty of each person. These external factors must also be considered among

the weaknesses of the project. An answer to this might be the setting up of a participation sheet for all persons interested in the workshop.

- A Bamboo cultivation or wood import are indispensable for the project. The lack of local materials for vernacular building will prove to be more costly over time for Mauritius. Thus, renewable resources solution like bamboo can help curb this upcoming problem. The possibilities of simplified earth building shall also be researched and implemented.
- Once the project finalized, a BIM software will be best adapted for this modular project. Then, a digital platform will also be needed to register application, and automatically generate the project and its bill of quantities.

Conclusion

The main aim of this thesis of proposing an affordable green building method for social housing using modular and vernacular architecture has been achieved and each objective was addressed.

The difficulties faced mostly concerns the Atlas part. Materials prices were not easy to find since online prices differed greatly from one website to another. Many construction professionals and companies had to be contacted directly and very few responded. These prices also keep on fluctuating on the market. Thus, cost estimates remain indicative of the real value at the time this research has been carried out. However, the resulting project was worth this extensive research. Apart from gathering knowledge, it has helped to condense innovative techniques into a new alternative for construction in Mauritius and bamboo construction at a broader level.

This alternative yet has to be tested through further research. Recommendations for future works include the making of an intuitive digital platform through the use of BIM that can register social house applicants' demands, generate the project modules, and calculate all costs involved. Finally, the possibility of an "earth fabric" inspired from the common concrete fabric must be investigated through scientific experiment and research.

As a final word, I would like to add that the principle of user-accessible construction is not a new thing and it is important for people to understand how much resources and energy are consumed in order to construct a house. However, a house is a basic need and the welfare of the inhabitant will always prime over any other factor. This study is thus built on constructive criticism and a hope to rise discussions and implementation of more conscious building in our small island. Making architecture available to families in need of proper housing is what makes a democratic architecture.

BIBLIOGRAPHY

Books

MCQUAID, Matilda. Shigeru Ban. Phaidon Press, 2006.

Thesis

DELAHAYE, Pierre. L'Habitat d'urgence comme réponse à la vulnérabilité. ENSA Bretagne, 2013.

HAMOT, Louise. Le bambou comme matériau de construction en Europe : une lubie temporaire ou un système viable pertinent en devenir ? ENSA Nantes, 2017.

LO, Wan-ting. Le Bambou_En Asie, l'architecture en bambou, eut-elle répondre aux conditions de l'architecture contemporaine et du développement durable? ENSA Nantes, 2019.

MARKS, Leanne R. Straw-Bale as a viable, cost effective, and sustainable building material for use in southeast Ohio. College of Arts and Sciences of Ohio University, 2005.

NIU, Fei and JI, Xiao. Modularity And Flexibility In Architecture: A Prototype For Emergency Situations In Developing Countries. Politecnico di Milano, 2017.

PARKER, Harry William. Modular for architects. University of Texas at Austin, 2017.

RAMESSUR, Navneesh. Vers une histographique de l'architecture rurale à Maurice. ENSA Nantes, 2021

SUBRUN, Subirajsing. To what extent does the social housing "NHDC" Improve the Livelihood of the Beneficiaries in Mauritius? UoM Trust, 2017.

Research Paper

AUTAR, Bhotish Awtar. Mauritius: Social Housing_Social Movement and Low Income Housing in Mauritius. Tsinghua University, 2012.

KONG-WIN CHANG, James. Comparative energy and greenhouse gas analyses between small- and large-scale sugarcane production in Mauritius. KTH School of Industrial Engineering and Management, 2013.

LU, Chang. The Folding Bamboo Architecture. 2015.
<http://thesis.arch.hku.hk/2015/2015/12/22/the-folding-bamboo-architecture/>

WIDDER, Lynnette. Earth eco-building: textile-reinforced earth block construction. Columbia University Sustainability Management, 2017.

ZAFUAN, Husri et al. Bamboo Modular System (BMS) for New Eco Architecture. International Colloquium of Art & Design Education Research, 2014. 10.1007/978-981-287-332-3_54.

Article/ Magazine

ANKEL, Sophia. A construction expert broke down how China built an emergency hospital to treat Wuhan coronavirus patients in just 10 days. Business Insider, 2020.
[businessinsider.com/how-china-managed-build-entirely-new-hospital-in-10-days](https://www.businessinsider.com/how-china-managed-build-entirely-new-hospital-in-10-days) (accessed 03.08.21)

ARÁMBURO, Carlos Ortega. Social housing in Ciudad Acuña, Mexico, by Tatiana Bilbao Estudio. The Architectural Review, 2016. architectural-review.com/buildings/social-housing-in-ciudad-acuna-mexico-by-tatiana-bilbao-estudio (accessed 08.08.21)

BAINBRIDGE, Kathleen. Nomad Folding Flax Pavilion. IAAC, 2017. iaacblog.com/programs/nomad-folding-flax-pavilion/ (accessed 04.08.21)

BAYONA, Delia. Architects Propose 120 Incremental Social Houses for Iquitos, Peru. Archdaily, 2018. archdaily.com/889897/architects-propose-120-incremental-social-houses-for-iquitos-peru (accessed 04.08.21)

BOANO, Camillo and KELLING, Emily. Towards an Architecture of Dissensus: Participatory Urbanism in South-East Asia. The Participatory Turn in Urbanism, 2013, Issue 13, p. 41-62.

CROOK, Lizzie. Studio Bark's flat-pack U-build system lets anyone self-build. Dezeen, 2019. dezeen.com/2019/05/10/ubuild-studio-bark-modular-architecture/ (accessed 04.08.21)

CRUZ, Daniela. Tatiana Bilbao's \$8,000 House Could Solve Mexico's Social Housing Shortage. ArchDaily, 2015. archdaily.com/775233/tatiana-bilbaos-8000-house-could-solve-mexicos-social-housing-shortage (accessed 04.08.21)

DOBBINS, Tom. Sombra Verde's 3D Printed Bamboo Structure Bridges the Gap Between Tradition and Technology. ArchDaily, 2018. archdaily.com/897117/sombra-verdes-3d-printed-bamboo-structure-bridges-the-gap-between-tradition-and-technology (accessed 07.08.21)

FAKUDEEN, Jilani Ahmad. High time for Mauritians to take up recycling seriously. Le DEFI MEDIA group, 2019. <https://defimedia.info/high-time-mauritians-take-recycling-seriously>

FRYE, Megan. What is 'superadobe'? BBC Future, 2019. bbc.com/future/article/20190228-what-is-superadobe (accessed 04.08.21)

GERINI, Jorge. Anupama Kundoo: 'Current Methods of Construction are Producing More Problems Than They Solve'. ArchDaily, 2017. archdaily.com/880897/anupama-kundoo-current-methods-of-construction-are-producing-more-problems-than-solving-it (accessed 04.08.21)

GIS. Evicted squatters will benefit from NHDC assistance, says Minister Obeegadoo. GIS 3 June, 2020.

Holcim Foundation. Adaptable Portable Modular housing for urban poor. 4th Holcim Awards, 2015. holcimfoundation.org/projects/adaptable-portable (accessed 04.08.21)

H&P Architects. low cost bamboo housing in vietnam by H&P architects. Designboom, 2013. designboom.com/architecture/low-cost-house-for-middle-vietnam/ (accessed 04.08.21)

JENSEN, Peter. Own the First US EcoCocon Straw Panel Tiny House, \$125k. Upstater, 2020. upstater.com/straw-panel-house-125k/ (accessed 06.08.21)

JONES, Nick. A century of prototypes: A capsule history of modular architecture. The Possible, 2016. the-possible.com/six-examples-of-modular-construction/ (accessed 04.08.21)

JULISTIONO, Eunike Kristi et al. Transitional shelter for disaster victims: Bamboo core and incremental houses. DIMENSI Journal of Architecture and Built Environment, 2014, vol. 41, n° 1, p. 29-36. ISSN 2338-7858

KAMINSKI, Sebastian et al. Structural use of bamboo Part 2: Durability and preservation. ResearchGate, 2016.

KHAN, Nisar. Critical assessment of affordable housing policy in the Republic of Mauritius vis a vis five principles of housing adequacy. International Journal of Advance and Innovative Research, 2019, vol. 6, n° 2, p. 79-86. ISSN 2394 - 7780

Material District. Mobile factory turns debris into building blocks for a new life. Material District, 2016.
materialdistrict.com/article/mobile-factory-turns-debris-into-building-blocks-for-a-new-life/ (accessed 07.08.21)

MOONEN, S. P. G. Rapidly building with lightweight modules and a dry assembled foundation: used in a mock-up for home units made out of reclaimed materials. WIT Transactions on The Built Environment. WITPress, 2014, vol. 136, p. 209-221. ISSN 1743-3509

NELSON, Daniel. Cutwork develops innovative 'just add water' concrete refugee shelters. Designboom, 2019.
designboom.com/architecture/cutwork-cortex-refugee-shelter-concrete-09-20-2019/ (accessed 06.08.21)

NADY, Riham. Modular Architecture: When Beauty and Efficiency Meet. Arch20, 2015. arch20.com/language-modular-architecture/ (accessed 03.08.21)

STECKELINGS, Sara. Modular Architecture – It's the Future. ArchitectureQuote, 2019. <https://architecturequote.com/modular-architecture/> (accessed 04.08.21)

STEVENS, Philip. shigeru ban examines different prototypes for refugee settlement in kenya. Designboom, 2018.
designboom.com/architecture/shigeru-ban-kalobeyei-refugee-settlement-kenya-08-05-2018/ (accessed 05.08.21)

SCHRÖDER, Stéphane. Bamboo Joints and Joinery Techniques. Guadua Bamboo, 2009.
guaduabamboo.com/blog/joining-bamboo (accessed 07.08.21)

SINHA, Sandipan. Use of Bamboo in Sustainable Building. Slideshare, 2013.
slideshare.net/sinhasandipan/use-of-bamboo-in-building-sustainable

STOTT, Rory. The Paradoxical Popularity of Jean Prouvé's Demountable Houses. ArchDaily, 2016.
archdaily.com/782589/the-paradoxical-popularity-of-jean-prouves-demountable-houses (accessed 04.08.21)

TEBBUTT, Luke. Penda's modular bamboo hotel could be expanded horizontally and vertically. Dezeen, 2014.
dezeen.com/2014/07/13/penda-one-with-the-birds-modular-bamboo-hotel/ (accessed 05.08.21)

VALEUR, Idha. Q&A with Cutwork CMO Bryce Willem. Materials World, 2019
materialsworld.tumblr.com/post/188855106179/qa-with-cutwork-cmo-bryce-willem

VELASCO ESPÍN, Paola. Low-cost modular housing scheme. Architecture-in-Development. 2016
architectureindevelopment.org/project/210 (accessed 04.08.21)

ZATARAIN, Karina. Jalisco, Mexico: Prototype for INFONAVIT, by ZD+A and Iñaki Echeverría. ArchDaily, 2017.
archdaily.com/877604/jalisco-mexico-prototype-for-infonavit-by-zd-plus-a-and-inaki-echeverria (accessed 04.08.21)

ZILLIACUS, Ariana. Half A House Builds A Whole Community: Elemental's Controversial Social Housing. ArchDaily, 2016.
archdaily.com/797779/half-a-house-builds-a-whole-community-elementals-controversial-social-housing (accessed 04.08.21)

Report

CCM (Competition Commission of Mauritius). Market Study of the Construction Industry in Mauritius. 2018.

CHAGNY, Maïti. Overview of Social Housing Programs Effectuated in Mauritius since the 1960's by the Government, Private sector and NGOs. UNDP and MOHL, 2013.
Mauritius National Assembly. Debate no. 20 of 2020. Hansard, 2020. mauritiussassembly.govmu.org/Pages/Hansard.aspx

Ministry of Foreign Affairs, Regional Integration and International Trade. Voluntary National Review Report of Mauritius. High Level Political Forum, New York, 2019.

MOHL. The Habitat III National Report. UN Conference on Housing and Sustainable Urban Development(Habitat III), 2014.

UN Environment Programme. 2020 Global Status Report for Buildings and Construction). Towards a Zero-emission, Efficient and Resilient Buildings and Construction Sector, Nairobi, 2020.

Conference

PRECHT, Chris. Penda Studio. ASA FORUM 2018, Thailand, 2018.
youtube.com/watch?v=XdAMB5RLIDw (accessed 05.08.21)

Videos

BOON-LONG, Yanyong. Participatory Architecture. [online video]. YouTube, 2009.
youtu.be/DNyZzZIMCQA (accessed 04.08.21)

Guidelines

PÉREZ, Celia Izquierdo. Hurricane Resilient Wooden Houses. Habitat for Humanity International (HFHI). 2nd Edition. Roseau, Dominica, 2018.

— Annex

ECOLE NATIONALE SUPERIEURE D'ARCHITECTURE DE NANTES
DOCUMENT SOUMIS AU DROIT D'AUTEUR

Master1 Research Thesis - Interview of an architect

ENSA Nantes Mauritius

Khushboorani Beekawoo

Architect, Project Manager, Consultant: Dharam Dev Bunjun, D.D Bunjun Architects

Date: 09.02.20

A. Actual situation

- Is construction in Mauritius getting more
-unidentifiable (not unique and no architectural identity)
The Mauritian architectural identity is starting to take shape.
Before, we had the traditional colonial architecture "maison créole" and we may have lost track of it to adopt modern style, as the "maison créole" is very costly.

-unsustainable? (pollution, materials,)
Yes, it's far from being sustainable. After Carol cyclone had destroyed all wooden and iron sheet houses (Lakaz toll), a fear was born in the population, leading to the adoption of concrete block housing. In a tropical country like Mauritius, construction is done without consideration for orientation.
But, concrete building could be considered sustainable, with some minor adjustments like orientation.

-undemocratised? (complex and expensive)
Expensive yes, the inflation rate is 6-10% per year.
The cost for a house is minimum Rs 1200/ft² (Rs 12920/m²) and average Rs 2000/ft² (Rs 21530/m²)
- When you design, do you have in mind a Mauritian architectural identity?
Yes, but it also depends on the client.
- With which materials do you mostly build?
Concrete, but I have started a wall treatment, through plaster-of-paris insulation on west wall, which reduces temperature by 3-4°C.
The comfort temperature is 26-28°C and the humidity level is 40-60%.
- Do users participate in the design and construction processes?
In design yes, but not in construction, due to lack of knowledge of building. But they often interfere with construction, through requests for modification, etc.

B. Prefab/modular architecture

A modular building is one made of modules, prefabricated in factories, which can be rapidly assembled on-site to make a whole building, and also disassembled if ever need be. It can be considered as a "LEGO" building method.

- Do you think prefab is a good solution for a more sustainable construction? (What is your opinion?)
Yes. Firstly it helps diminish costs. For example, at Richelieu a low-cost project was made using "American Blocks" imported from La Reunion, and figured in a documentary film by Mauritius College of the Air and Mauritius Research Council. 3 houses were built within 3 months by around 10 people. There are thus many advantages in modular construction like quality control, time frame and cost.
- Does the architect play a major role in prefab?
Yes. In Mauritius, "prefab" exists in the form of prefab concrete slabs, beams, Basalt T-sections, and smart blocks like American blocks, and projects always includes consultants, including architects.
- Is it a boon or a bane for construction industry workers? Local craftsmen/mason?
No it is not a bane. Prefab is easy for masons, who are easy-learners. Minimum labour is needed for laying blocks and rendering. It is a Do-It-Yourself method but it is not a threat at all.

C. Vernacular architecture

A vernacular building is one made with local resources, by local people, with respect to local climatic conditions. It can be considered "endemic" to the region.

- Mauritius used to have a traditional colonial architecture. Why do you think this changed?
Refer to question 1.
- Presently, is there scope for a vernacular architecture like Africa in Mauritius?
Yes, and no. However, the comfort conditions in this type of architecture are very interesting, like the natural air conditioning. In the "Le Morne Replica Village" project made by the Ministry of Arts & Culture, 5 thatched huts with traditional cow-dung "sali" (floor) were built. In that building, you can feel the difference. It is worth a visit. It is also based on the concept of community-living as it has one kitchen for 8 families.
- Which materials can be considered vernacular for Mauritius? (wood, straw, bricks)
Mud, cow dung which is moisture absorbent, pine wood although it is imported from South Africa, it is readily available; straw from sugarcane or rattan, bamboo, which is also imported. The company Corobrik at Riche Terre imports bricks from South Africa
- Can concrete be replaced?
Yes, vernacular means no concrete. But it also involves many costs.

D. New Modular-Vernacular Building method

This concept of modular-vernacular architecture confronts two quite opposite and non-contemporaneous architecture. It is based on the 3R's principles (a building conceived as a recyclable product) and fosters the idea of the collective.

THESIS QUESTION: If Mauritius comes to integrate a Lego-like modular and vernacular construction method for instance at an experimental scale, to respond to the immediate social housing demands, would this be a viable option for a more affordable, ecological, democratised and finally identifiable Mauritian architecture?

- Possibility of the project
-Changing the architecture of a country is a great vision. But is this type of modular architecture possible in Mauritius? Does it already exist?
This is a long time process but yes, provided it is safe, comfortable, meets the costs requirements, and the maintenance is not exorbitant.
- Social aspect
-Social housing is indeed an increasing demand. But will the people approve of such an architecture, considering that here a concrete house is a pride and cliché of a safe habitat?
Yes, the demand of social housing is high; there is a huge backlog and many people are still waiting to be allocated a house. Around 2000-3000 houses have been made in the last 5 years. A funding from the Indian government of Rs 2-3 billion to make 2000 houses at costing Rs 1000/ft².

-As architects, what are the criteria to consider? (thermal comfort, resistance, plumbing)
Refer to question 8
- Democratisation
-Would it be more economically viable, so as to consider its application for social housing projects?
Yes, if materials are being imported from Asia or Africa, it will definitely be less costly. Wood is comfortable, termite treatment is not expensive and is applied each 5 years.

-Do you think if "building becomes like a lego game," users will be enthusiastic to participate in building their house?
Yes. Apart from saving costs, it is a pleasure and satisfaction of having to participate.
- Consequence/ Repercussion
-Will workers in the construction industry see this as a threat to their job rather than an opportunity to work together with users?
No

-This construction method mobilises a factory-production process, so do you think it can open job opportunities for these workers?
Yes. The trend of Do-It-Yourself is getting more and more popular now, in America its extensive.
- Vernacular
Which materials can be used for this new method? (wood, stone, steel, recycled plastic, cement board)
Refer to question 6

Last opinions and advice

The project is not a bad idea; you should make a research on Materials. For instance, for the structure, the conventional method can be used, while the infill can be vernacular.

Interview of an NHDC Officer

Satyam Ramma, Project Manager

26.04.21

I am a Mauritian student doing a Masters thesis on Social Housing in Mauritius, under the supervision of Mr Laurent Lescop, and mentored by Mr Dharam Bunjun, professional practising architect. In my research paper, I need to portray a case study of a typical NHDC social housing unit and the following information are essential.

- What are the regulations and essential requirements for all social housing ? (area, number of rooms, height, openings...)
The NHDC has constructed some 13,000 housing units since its creation back in 1991. The housing projects implemented to-date vary from single standing units to apartment type. As such, there is no specific regulation or requirement with regard to NHDC housing units, as far as architectural design is concerned. All NHDC projects are implemented in accordance with existing planning requirements and are subjected to approval from Local Authorities (e.g Building and Land Use Permits have to be obtained prior to construction).
The average size of housing unit being constructed nowadays is 50 m², and these units are provided with all necessary amenities – water pipes, electricity supply, sanitary wares, etc. The units are serviced by networks of road, footpath, drains, sewage disposal, water pipes, street lighting and social amenities.
Housing units are designed in such a manner to allow beneficiaries to extend their dwelling, according to their needs and financial capability. The average plot size is 200 m² and adequate space is available for lateral and vertical extension of the units.
- Is there a typical layout plan which can be shared? a photograph?
Pictures and typical plans are enclosed.
- For 1 housing unit, what is the overall cost and construction time?
The construction cost of one unit is approx. MUR 1.5M, and contract duration (works) generally vary from 18 months to 24 months.
- What is the general feedback of residents?

Master1 Research Thesis - Interview of a Local clay specialist

ENSA Nantes Mauritius

Khushboorani Beekawoo

Local clay artist: Devanand Bungshee, Ananta Art Gallery

Date: 24.09.20



- Is Mauritius local earth suitable for construction of buildings? (Is the soil composition good enough?)
Yes
Local earth is extracted from Balaclava, where the most recent volcanic eruption is occurred. The earth is then baked with glass sand, bentonite is used for binding. Back during French colonisation, clay was used in buildings with stone walls. However, for earth bricks to be fire-resistant, it has to be mixed with rock powder.
- Or is it better to import?
Yes, resources are limited here. Clay fire bricks are imported from South Africa
- Which is better: cob building, rammed earth walls, or adobe bricks? (in terms of structure)
Rammed earth will erode, which is also why bricks must be baked. They resist humidity better, higher temperatures and have a longer lifetime, when mixed with rock powder.
Earth mixed with cow-dung also is a very good material used in construction in the past.
- Any cost estimates?
-
- What is the lifetime and maintenance cost?
Very good

Master1 Research Thesis - Interview of a Bamboo specialist
ENSA Nantes Mauritius
Khushboorani Beekawoo
Bamboo specialist and Architect: Fatima Martin Alvaro, Bambulenat
Date: 03.08.21

Greetings Mrs Fatima Martin

I am a Masters student from ENSA Nantes-Mauritius, currently in Nantes.
I am writing a thesis on A Modular Bamboo Architecture for Social Housing in Mauritius, under the supervision of Mr Laurent Lescop, and mentored by Mr Dharam Bunjun, professional practising architect.

In my research paper, I need to make a Cost Comparison between a house made of Bamboo vs other Conventional materials (concrete, etc.)
Following your workshops and conference about Bamboo in Mauritius, you are among the few professionals in the field who have local experience and who can guide me.

For instance, the information I require are as follows:

1. What is the approximate general cost of Bamboo constructions?
Its not that easy to answer that quick. The cost of the bamboo depends on different factors
At this moment the cost of bamboo construction is the same, even a little superior than concrete, but lower than wood. This is because we have to train labour and it is a lot of hours of work to invest. We don't have enough suppliers of bamboo in order to make it more cost-effective.
2. If I were to construct a typical small house in bamboo in Mauritius today, how much would it cost per sqm?
If right now you need to start a bamboo project, you can consider it the same rate as a concrete construction in Mauritius. It will not be cheaper at this moment.
3. If Mauritius starts bamboo cultivation for construction, will it be more affordable?
It will definitely be cheaper but the main issue is not the economy factor but the security factor. The challenges I faced when doing projects in Mauritius is that it is a cyclone-prone country. For these regions, bamboo structures require very detailed joinery. In Bali or Indonesia, the local craftsmen are very skilled and quickly produce intricate joinery. But here there are no specialised labour, it would be difficult for local carpenters too.

Concerning the modular aspect, I don't work on prefabricated structures. But my concern is that "do these resist to cyclone, strong gusts, etc?" There is only one Hawaii-based bamboo company called Bamboo Living that has a certification for fire-resistance. They make prefabricated houses. They make personalised design and then ship all the parts to you from Vietnam. Some of their houses have survived very strong storms. They have come up with 4 to 5 basic principles, for e.g octagon joints are 200 times more efficient than cube joints, because of the way the forces accumulate tension at one joinery. Another example is the 30-degree pitch which is better than the flat roof.

Master1 Research Thesis - Interview of an Earth specialist
ENSA Nantes Mauritius
Khushboorani Beekawoo
Earth construction specialist, Engineer and Researcher: Marta Miranda Santos, CRENAU
Date: 12.04.21

Mon 12/04/2021 15:02
Bonjour Marta

Je vous envoie la référence dont je vous ai parlé à l'atelier jeudi à propos de ma thèse. C'est une nappe en béton appelé "Concrete canvas" qui est prévu pour être utilisée comme revêtement d'un habitat d'urgence "Cortex Shelter".

Cortex shelter
<https://cutworkstudio.com/cortex-shelter>

Composition
<https://youtu.be/9mXoK5hp3bE>
<http://concreteproducts.com/index.php/2021/02/22/patent-expansively-covers-geosynthetic-cementitious-composite-mat-concept/>

Cependant, dans ma thèse, je me demande si on peut remplacer le béton ici par une matière plus écolo, comme la terre. Pouvez-vous me partager vos avis sur ce sujet? Ou même me renvoyer vers d'autres personnes qui en sauraient davantage?T

Merci pour votre aide.

Cordialement
Khushboorani Beekawoo
Etudiante M2 - UET Terre Crue

Miranda Santos Marta
Tue 20/04/2021 12:15
Bonjour

Je pense qu'avec de la terre ça va être compliqué.... Pouvoir "enrouler" de la terre c'est assez "improbable". En plus, le "Concrete canvas" est utilisé sans soubassement et comme toiture, pas terrible à faire avec de la terre.

Bonne Journée
Marta

Master1 Research Thesis - Interview of an NGO officer
ENSA Nantes Mauritius
Khushboorani Beekawoo
NGO Officer: Cursley Goindoorajoo, Caritas Mauritius
Date: 26.02.20



A. Actual situation

1. Media reports that there is an increasing demand for social housing in Mauritius.
How would you describe the actual situation? (urgent,)
It is quite urgent. Since 20 years, no big cyclone was witnessed. But as a cyclone comes, it will be really urgent.
2. Who are the people in need of social housing?
Firstly, low income groups people living in deprived neighborhoods. Only house inheritors with Rs 100,000 on their bank account will benefit from NHDC social housing
Secondly, workers owning house from Propriétés Sucrées
Thirdly, only families and not single persons.
Fourthly, homeless persons.
How many are they?
Where is it the most urgent?
It depends, but social project should not be done in mass quantities, but rather in different places.
3. Social housing projects are ongoing but are said to be very slow.
Are there adequate measures being taken to build houses?
Is it enough? Sadly, no
How many organisations work in this field in Mauritius? (Government, NGOs)
Only government provides social housing.

B. The organisation

4. From when did your organisation start social housing projects?
How many projects/social housing units have you accomplished?
How many are you projecting to accomplish in the future?
We do not construct but rather support and accompany people in seeking better housing facilities.
5. How many people work in your company?
Mostly volunteers including voluntary architects,
Which professions are there?
Depends on the field, for example housing, education, life skill management, etc.
6. Who designs the houses and amenities?
Refer to question 5
7. Do you have specific building standards to follow in design/construction?
-specific protocols (site study, family situation...)
-standards (size, height, number of rooms...)
-budget

-materials
All should be according to standard norms, while for materials it should be concrete, unless the property is not theirs, because cyclone resistance is a requirement for all structures at national level.
Some references of alternative materials can be the African tin houses, or recycled clothes, bricks, etc

C. Construction

8. Do you think construction in Mauritius is getting more complex and expensive? (undemocratised)
9. Do people participate in the design and construction processes of their new house in social housing projects?
Yes, as long as they get the opportunity to! Manoeuvre needed in a project can account to Rs 200,000 but can be substituted for unskilled labour. Long ago, communities used to build houses together, in a convivial atmosphere.
We made a demand project to the government in view of a Participatory Slum Upgrading Programme (PSUP) but it was not carried forward.
10. In Mauritius, houses were once built with wood, straw, stone, etc, while today, mostly only concrete is used.
Which materials are used
o for the actual houses? concrete
o for the new houses? concrete

D. New Modular-Vernacular Building method

THESIS QUESTION: If Mauritius comes to integrate a Lego-like modular and vernacular construction method for instance at an experimental scale, to respond to the immediate social housing demands, would this be a viable option for a more affordable, ecological, democratised and finally identifiable Mauritian architecture?

Modular building: made of modules, prefabricated in factories, which can be rapidly assembled on-site to make a whole building, and also disassembled if ever need be like "LEGOs". (3Rs principle: recyclable building)
Vernacular building: made with local resources by local people, with respect to local climatic conditions. (collective)

11. Possibility of the project
Do you think prefab is a good solution for social housing? (What is your opinion?)
If it is cyclone-resistant and less costly, yes
12. Social aspect
-Will people approve of such an architecture, considering that here a concrete house is a pride and cliché of a safe habitat?
In the beginning, they can be reluctant or critical but it will be gradually accepted, exactly what happened for the Light Rail "Metro Express" Project.
-What are the criteria/building standards to consider?
Design by the current building norms. Once a 10 by 12 feet or 38 m² house was designed but sadly the bed could not fit in and had to be cut. The ideal would be 50 m²
13. Democratisation
-Do you think if "building becomes like a lego game," users will be enthusiastic to participate in building their house? Yes
-Do you think this project is economically viable? Yes, participative is a very good method and might cost less
14. Consequence/ Repercussion
-Will workers in the construction industry see this as a threat to their job rather than an opportunity to work together with people? No, on the contrary, they will be happier that the work is being done in less costs.
15. Vernacular
Which materials do you recommend using for this project? (wood, stone, steel, recycled plastic, cement board)
Caritas is for environment-friendly construction.

Can any paper (building standards, laws, protocols, studies) or anything deemed important for a social project be made available for my consultation/to include in my research project?

Research papers on the subject of social housing can be found in the library of the University of Mauritius.
A participative village was constructed by Père Pedro in Madagascar and can be studied.
Bricks are a very good alternative, earth was often used with cow dung for flooring or "sail rouge"

A Mauritian architecture survey

Hi Mauritian friend!
I am Khushboo Beekawoo, student from Nantes School of Architecture (ENSA Nantes-Mauritius).

This survey forms part of my Master Thesis research project to discover if our island can adopt a new, more sustainable construction method, which can help the social housing sector.

In Mauritius, many people do not own a proper house and live in poor conditions. With construction costs getting higher and natural disasters becoming more frequent, even the numerous social housing campaigns, both by the public and private sector, are finding it hard to provide a concrete house to each family in need.

This is why I am making a census / collecting your opinions about the actual construction methods in Mauritius and the new eco-friendly materials to be considered.

Thank you for precious time and help!

*Required

About you

1. Age *

Mark only one oval.

- below 18
 18-50
 above 50

2. Profession *

Mark only one oval.

- Student
 Working
 Other: _____

3. Profession / Study field *

Mark only one oval.

- Architecture/Construction field
 Other: _____

About your house

9. Did you think about the future of your house if you move out/leave the house? *

Mark only one oval.

- Sold / Willed
 Demolished
 Recycled (materials, components, ..)
 No idea
 Other: _____

Your opinions

10. Did you know 38% of CO2 emissions is generated by buildings and the construction industry? This includes manufacturing, transportation, and use of construction materials, especially for concrete structures. (IEA, 2019) *

Mark only one oval.

- Yes
 No

11. Do you know what is a modular building? A modular building is similar to a LEGO house. There are few or many prefabricated parts, called modules, which can be rapidly assembled to make a whole building. Depending on the materials used, once the building has served its purpose, it can either be disassembled to reuse the modules; or it can be recycled completely, thus leaving little if no carbon footprint. *

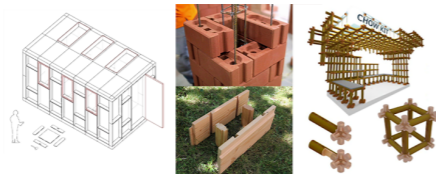

U-Build Kit (studiohark.co.uk), Malaysian Interlocking Bricks (myib.com.my), Brikawood (brikawood-ecologie.fr), Bamboo Modular System (aboutus.at/dst1)

Mark only one oval.

- Yes
 No, just discovered!

4. How old is your house? *

Mark only one oval.

- 0-10 years
 11-20 years
 above 20 years

5. Did you participate in your house construction? *

Mark only one oval.

- Yes
 No

6. Your house is made of which materials? Tick any *

Tick all that apply.

- concrete
 wood
 steel structure (+ partitions, iron sheet)
 earth brick
 stone
Other: _____

7. Did you wish to participate more in your house construction? *

Mark only one oval.

- Yes
 No

8. Would you have preferred your house to be made with other materials? Tick any *

Tick all that apply.

- greener concrete
 wood
 steel structure (+ partitions, iron sheet)
 earth brick
 container house
 natural materials (bamboo, straw, clay ..)
 recycled materials (plastic, paper, cloth..)
Other: _____

12. If you need to build a house for your family, would you prefer a traditional house or a modular house? *

Mark only one oval.

- Traditional house
 Modular house

13. Among the options below, which do you prefer? *

Mark only one oval.

- Prefabricated house (custom design, completely assembled in factory, delivered on site by crane)
 Do-it-Yourself Kit (all parts delivered in a flat pack with instructions, for you to assemble on site)
 Do-it-Yourself Kit with Technical Assistance
 Do-it-Yourself Process (Community-based workshop, you participate in producing the modules and build house together)
 Other: _____

14. Do you think modular construction is a good solution for solving the social housing problems facing Mauritius? *

Mark only one oval.

- Yes
 No

15. Any comments or suggestions

This content is neither created nor endorsed by Google.

Google Forms

A Mauritian architecture survey

100 responses

About you

Age

100 responses



Profession

100 responses

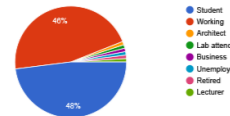

Profession / Study field

100 responses

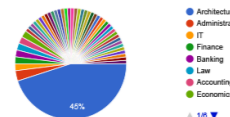

About your house

How old is your house?

100 responses

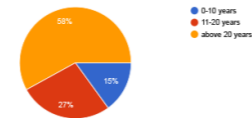

Did you participate in your house construction?

100 responses

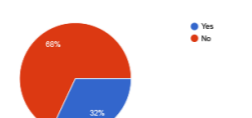

Your house is made of which materials? Tick any

100 responses

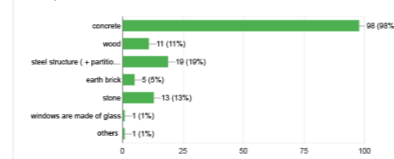

Did you wish to participate more in your house construction?

100 responses

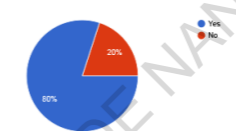

Would you have preferred your house to be made with other materials? Tick any

100 responses

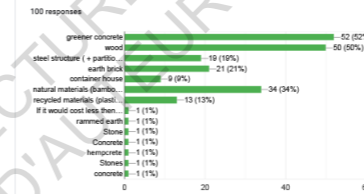

Did you think about the future of your house if you move out/leave the house?

100 responses

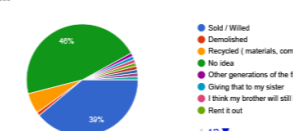

Your opinions

Did you know 38% of CO2 emissions is generated by buildings and the construction industry? This includes manufacturing, transportation, and use of construction materials, especially for concrete structures. (IEA, 2019)

100 responses

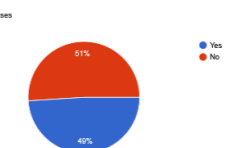

Do you know what is a modular building? A modular building is similar to a LEGO house. There are few or many prefabricated parts, called modules, which can be rapidly assembled to make a whole building. Depending on the materials used, once the building has served its purpose, it can either be disassembled to reuse the modules; or it can be recycled completely, thus leaving little if no carbon footprint.

100 responses

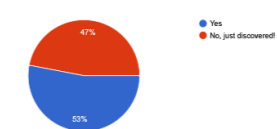

If you need to build a house for your family, would you prefer a traditional house or a modular house?

100 responses

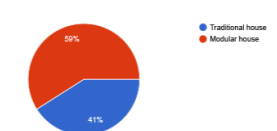

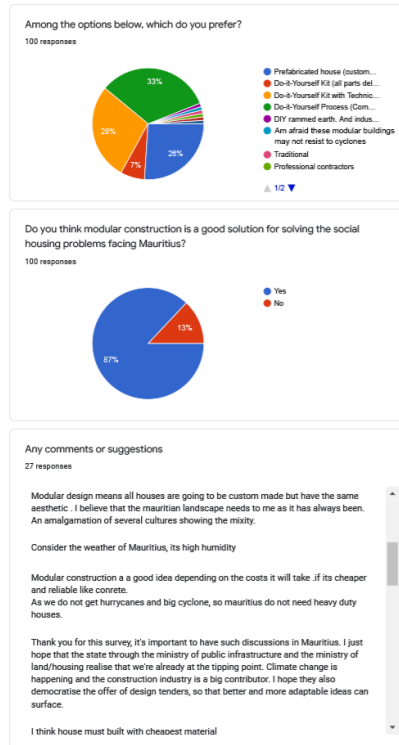

Google Forms



ECOLE NATIONALE SUPERIEURE D'ARCHITECTURE DE NANTES
DOCUMENT SOUMIS AU DROIT D'AUTEUR

WOOD PROPOSAL COST ESTIMATE

component	number	material	Unit quantity	Total quantity	Unit price	Total cost
Module	325		per module			
		lumber (m) (50x50mm)	5.4	1755	100	175,500
		jute (m2)	1.32	429	12	5148
		straw (m3)	0.08	26	150	3900
		screws (number)	16	5200	1	5200
		plywood (m2 of 20 mm)	0.08	26	520	13520
Half Module	80					
		lumber (m) (50x50mm)	5.4	432	100	43200
		jute (m2)	0.76	60.8	12	730
		straw (m3)	0.04	3.2	150	480
		screws (number)	16	1280	1	1280
		plywood (m2 of 20 mm)	0.08	6.4	520	3328
Concrete Base						
		Concrete (m3)		12.1	4500	54450
		Reinforcement (kg)		74	56	4144
Ground anchor	9 (8 + 1 interior)					
	25x200 mm	wooden base plate (m)		27	413	11151
	each metre	anchoring bolt and nut (unit)		27	8	216
	x44 ground modules	screws (number)	4	176	2	352
Vertical joints						
	x 450 modules	screws (number)	4	1620	2	3240
Angular joint 150deg	10					
		lumber (m) (50x50mm)	1.9	19	100	1900

		plywood (m2 of 20 mm)	0.22	2.2	520	1144
		metal cleat (unit)	4	40	1	40
		screws (number)	26	260	1	260
Angular joint 120 deg	10					
		lumber (m) (50x50mm)	1.4	14	100	1400
		plywood (m2 of 20 mm)	0.22	2.2	520	1144
		metal cleat (unit)	2	20	1	20
		screws (number)	22	220	1	220
Angular joint 90 deg	10					
		screws (number)		32	1	32
Additional Bracing						
		beam lumber (m) (50x50mm)		58.4	100	5840
Openings						
		door (m2)		12	2700	32400
		window (m2)		6.4	2700	17280
TOTAL MATERIAL COSTS						387,519
Labour	25% of total cost					96879.75
TRANSPORT	2 lorries					10000
TOTAL COST WITHOUT FINISH						494,399
FINISH						
total surface	earth			228		
	tiling	floor		48.7	500	24350
		walls		320		9300
		3.69m3 for 1cm thick plastering =300kg of lime needed				
	roof			19.5	650	12675
						46325
						594800
						with 10% contingency
	bamboo					
	tiling	floor		48.7	500	24350
		walls		320	350	112000
		roof		19.5	650	12675
						149025
						707800
						with 10% contingency
	tiling	floor		48.7	500	24350
		walls		320	350	112000
		roof		19.5	650	12675
						149025
						707800
						with 10% contingency

BAMBOO PROPOSAL COST ESTIMATE

component	number	material	Unit quantity	Total quantity	Unit price	Total cost
Module	325		per module			
		bamboo (m) (5cm thick)	5.8	1885	6 (10cm)	9048
		jute (m2)	1.32	429	12	5148
		straw (m3)	0.08	26	150	3900
	12 (0.1 m)	dowels (m)	1.2	390	30	11700
	12	rope (m)	9.6	3120	7	21840
Half Module	80					
		bamboo (m) (5cm thick)	4.2	336	6 (10cm)	2016
		jute (m2)	0.76	60.8	12	730
		straw (m3)	0.04	3.2	150	480
	12	dowels (m)	1.2	96	30	2880
	12	rope (m)	9.6	768	7	5376
Concrete Base						
		Concrete (m3)		12.1	4500	54450
		Reinforcement (kg)		74	56	4144
Steel joint Ground anchor	9 (8 + 1 interior)					
	25x200 mm	wooden base plate (m)		27	413	11151
	each metre	anchoring bolt and nut (unit)		27	8	216
	(0.064 m2)	steel plate		9	113	1017
	4 (120mm)	bolt and nut	4	36	2	72
Vertical joints	1360					
		bamboo (m) (4.4cm thick)		544	6 for 10cm	3264
	2720 (1360x2 of 0.1m)	dowels (m)		272	30	8160
Angular joint 150deg	40					
		lumber (m of 3x3")	0.07	2.8	427	1200
		plywood (m2 of 20 mm)	0.0176	0.3872	520	200

		metal cleat (number)	(x4)	88	1	88
		screws (number)	(x4)	88	0.5	44
Angular joint 120 deg	40					
		lumber (m of 3x3")	0.07	2.8	427	1200
		plywood (m2 of 20 mm)	0.0176	0.3872	520	200
		metal cleat (number)	(x4)	88	1	88
		screws (number)	(x4)	88	0.5	44
Angular joint 90 deg	40					
		lumber (m of 3x3")	0.07	2.8	427	1200
		plywood (m2 of 20 mm)	0.0176	0.3872	520	200
		metal cleat (number)	(x4)	88	1	88
		screws (number)	(x4)	88	0.5	44
Additional battens	100	bamboo (m) (5cm thick)	0.5	50	6 for 10cm	300
Lashing rope	100	rope (m)	1.5	1500	7	10500
Openings		door (m2)		12	2700	32400
		window (m2)		6.4	2700	17280
TOTAL MATERIAL COSTS						210668
Labour	25% of total cost					52667
TRANSPORT	2 lorries					10000

TOTAL COST WITHOUT FINISH						273335
FINISH						
total surface	earth			228		
	floor			48.7	500	24350
	3.69m3 for 1cm thick plastering =300kg of lime needed	walls		369		9300
		roof		19.5	650	12675
						46325
						with 10% contingency
		bamboo				
	floor			48.7	500	24350
	walls			320	350	112000
	roof			19.5	650	12675
						149025
		thatch				with 10% contingency
						465700
	floor			48.7	500	24350
	walls			320	350	112000
	roof			19.5	650	12675
						149025
						with 10% contingency
						465700

CONCRETE HOUSE

350 sqm area, approx. 1000 m² construction

10 ft: 60,000 - 70,000 + VAT
20 ft: 80,000 - 90,000 + VAT
40 ft: 140,000 + VAT

Additional: 100,000 + VAT (interior, plumbing, window, doors)

Velocity: 100 km/h
House cost: 800,000 - 2.5 M R\$
Life: 30 yrs (painted each 3 yrs)
Project by Yonick Le Blanc

1 house: 21 ft x 5.32 ft
20 ft x 5.32 ft
40 ft x 5.32 ft

Flat pack available, 100% recyclable

Yonick Le Blanc: 20 ft: 350,000 R\$
40 ft: 450,000 R\$

WEIGHT REQUIREMENTS
20 ft: 20 tons (incl. roof + 125 \$)
40 ft: 40 tons

These:
- 3 houses
- 8 people family
- 3 containers (500 m³)
- Habitable space: 102 m²

CONCRETE HOUSE
Life: +20 yrs for a used 40 ft container.
Material: High quality Corrugated Steel.
Flooring: 23 mm hardwood.

CONSTRUCTION (approximate cost)
Life: +20 yrs for a used 40 ft container.
Material: High quality Corrugated Steel.
Flooring: 23 mm hardwood.

RESULTS CONCLUSION

Words:
- expensive in terms of space (most important)
- recycling wood does not guarantee 100% quality of wood (mainly from Amazonia) (sustainability)
- Show - distance - limited resource - expensive
- 3 houses work for centre de formation

Materials:
- AAC Block (Concrete)
- SIP
- Plywood
- MDP (Floorboard)
- OSB (Floorboard)
- Straw Bales
- Fibreglass
- Cement Board
- Concrete roof
- Lightweight concrete
- Glass
- Aluminium
- Steel
- Form
- Container House
- Steel Top g

Cost:
- 20 R\$ (wood), 3300 R\$ (house)
- 50 R\$ (land), 950 m² wall
- 60-200 R\$ (SIP)
- 118 (7m) 1.2 x 1.4 m
- 255 2000 R\$ (wood cost)
- 1950 R\$ (SIP), 3750 R\$ (SIP)
- 297 (5mm)
- 500 R\$ (wood)
- 800 R\$ (SIP) (wood cost)
- 292 (90mm) 7
- 832 R\$ (m²)
- 500 ft (house)
- 4500 R\$ (SIP)
- 390 R\$ (m)

Notes:
- AAC Block (Concrete)
- SIP
- Plywood
- MDP (Floorboard)
- OSB (Floorboard)
- Straw Bales
- Fibreglass
- Cement Board
- Concrete roof
- Lightweight concrete
- Glass
- Aluminium
- Steel
- Form
- Container House
- Steel Top g

SOLUTIONS BEYOND FORMING

Excavation
U-Build
Core Shell

wood or metal
metallic
concrete
brick

space frame
brick

3D
plans
frames
textures
details

Design
3D
plans
frames
textures
details

Cost + Production Cost Analysis
- total cost
- cost comparison
- time comparison
- energy efficiency

Design
3D
plans
frames
textures
details

Cost + Production Cost Analysis
- total cost
- cost comparison
- time comparison
- energy efficiency

CONCRETE HOUSE

1 container carries 3500 = 4 houses
Taking freight 1 20 ft container = R\$100,000
freight for 1 houses = R\$ 100,000
Taking house cost = 3300 R\$ (m²)
add freight = 250,000 R\$
Total cost for brick house = 230,000 R\$
including the freight for 3300 R\$ (m²)

Import Volume: which container?
Taking volume of brick: 0.001816 m³
Per house, Volume of brick needed = 0.001816 x 9720 = 17.6 m³
Taking volume of 4 containers of 20 ft = 80 m³
Limit capacity of a container = 40 500 bricks
Household bricks approximately
Take House = 60 m²
Total wall (inter + inner) = 2(0.23) + (1.4) x 3m high = 162 m²
Taking 60 bricks/m² wall, 162 x 60 = 9720 bricks

CONCRETE HOUSE
Life: +20 yrs for a used 40 ft container.
Material: High quality Corrugated Steel.
Flooring: 23 mm hardwood.

CONCRETE HOUSE

1 container carries 3500 = 4 houses
Taking freight 1 20 ft container = R\$100,000
freight for 1 houses = R\$ 100,000
Taking house cost = 3300 R\$ (m²)
add freight = 250,000 R\$
Total cost for brick house = 230,000 R\$
including the freight for 3300 R\$ (m²)

Import Volume: which container?
Taking volume of brick: 0.001816 m³
Per house, Volume of brick needed = 0.001816 x 9720 = 17.6 m³
Taking volume of 4 containers of 20 ft = 80 m³
Limit capacity of a container = 40 500 bricks
Household bricks approximately
Take House = 60 m²
Total wall (inter + inner) = 2(0.23) + (1.4) x 3m high = 162 m²
Taking 60 bricks/m² wall, 162 x 60 = 9720 bricks

CONCRETE HOUSE
Life: +20 yrs for a used 40 ft container.
Material: High quality Corrugated Steel.
Flooring: 23 mm hardwood.

CONCRETE HOUSE

1 container carries 3500 = 4 houses
Taking freight 1 20 ft container = R\$100,000
freight for 1 houses = R\$ 100,000
Taking house cost = 3300 R\$ (m²)
add freight = 250,000 R\$
Total cost for brick house = 230,000 R\$
including the freight for 3300 R\$ (m²)

Import Volume: which container?
Taking volume of brick: 0.001816 m³
Per house, Volume of brick needed = 0.001816 x 9720 = 17.6 m³
Taking volume of 4 containers of 20 ft = 80 m³
Limit capacity of a container = 40 500 bricks
Household bricks approximately
Take House = 60 m²
Total wall (inter + inner) = 2(0.23) + (1.4) x 3m high = 162 m²
Taking 60 bricks/m² wall, 162 x 60 = 9720 bricks

CONCRETE HOUSE
Life: +20 yrs for a used 40 ft container.
Material: High quality Corrugated Steel.
Flooring: 23 mm hardwood.

CONCRETE HOUSE

1 container carries 3500 = 4 houses
Taking freight 1 20 ft container = R\$100,000
freight for 1 houses = R\$ 100,000
Taking house cost = 3300 R\$ (m²)
add freight = 250,000 R\$
Total cost for brick house = 230,000 R\$
including the freight for 3300 R\$ (m²)

Import Volume: which container?
Taking volume of brick: 0.001816 m³
Per house, Volume of brick needed = 0.001816 x 9720 = 17.6 m³
Taking volume of 4 containers of 20 ft = 80 m³
Limit capacity of a container = 40 500 bricks
Household bricks approximately
Take House = 60 m²
Total wall (inter + inner) = 2(0.23) + (1.4) x 3m high = 162 m²
Taking 60 bricks/m² wall, 162 x 60 = 9720 bricks

CONCRETE HOUSE
Life: +20 yrs for a used 40 ft container.
Material: High quality Corrugated Steel.
Flooring: 23 mm hardwood.

CONCRETE HOUSE

1 container carries 3500 = 4 houses
Taking freight 1 20 ft container = R\$100,000
freight for 1 houses = R\$ 100,000
Taking house cost = 3300 R\$ (m²)
add freight = 250,000 R\$
Total cost for brick house = 230,000 R\$
including the freight for 3300 R\$ (m²)

Import Volume: which container?
Taking volume of brick: 0.001816 m³
Per house, Volume of brick needed = 0.001816 x 9720 = 17.6 m³
Taking volume of 4 containers of 20 ft = 80 m³
Limit capacity of a container = 40 500 bricks
Household bricks approximately
Take House = 60 m²
Total wall (inter + inner) = 2(0.23) + (1.4) x 3m high = 162 m²
Taking 60 bricks/m² wall, 162 x 60 = 9720 bricks

CONCRETE HOUSE
Life: +20 yrs for a used 40 ft container.
Material: High quality Corrugated Steel.
Flooring: 23 mm hardwood.

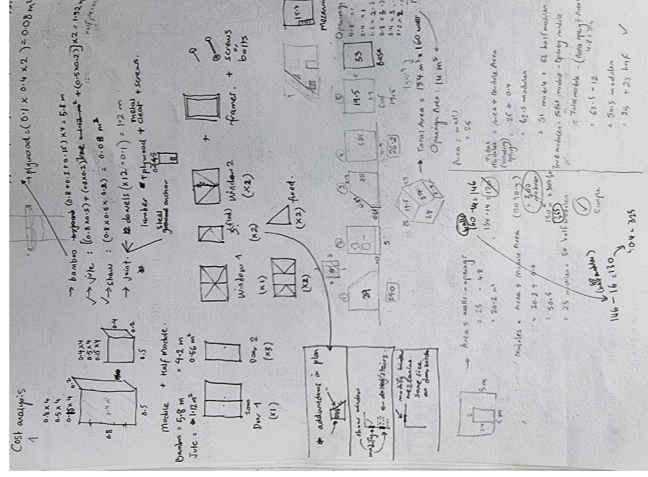
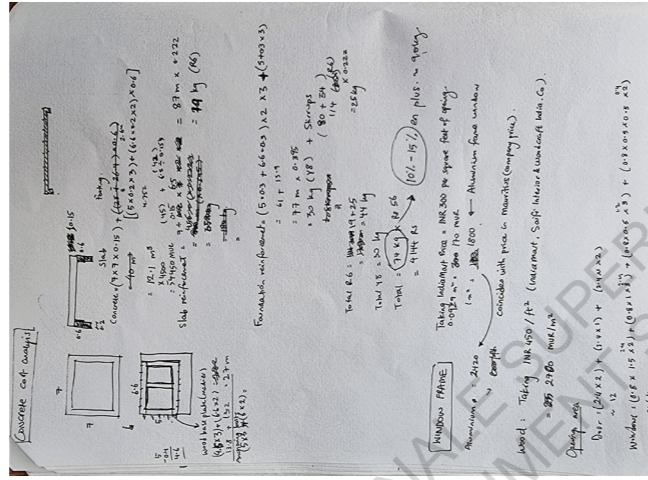
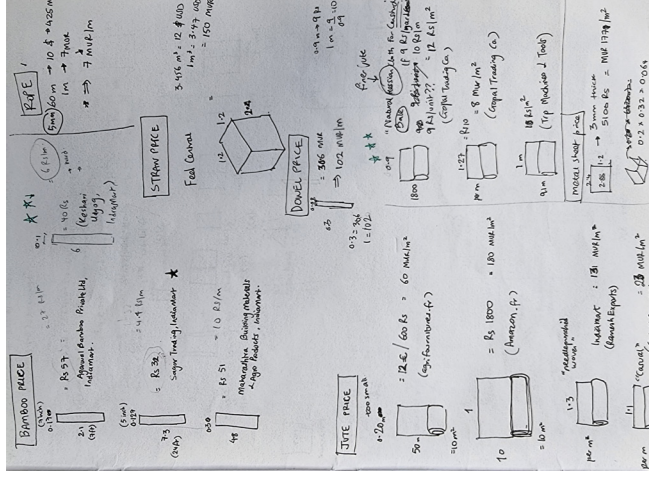
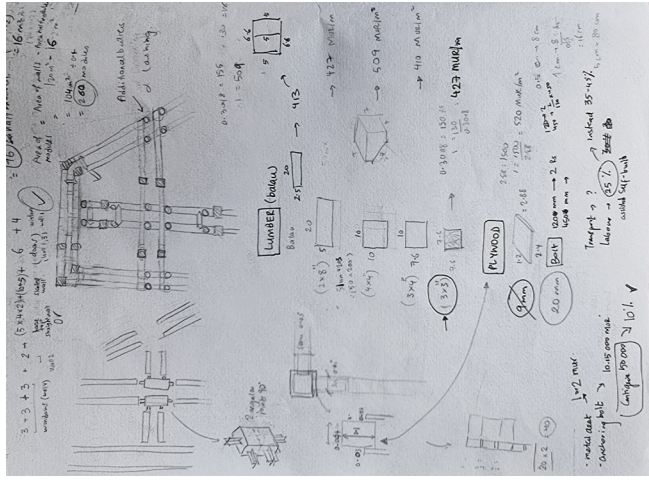

ECOLE NATIONALE SUPERIEURE D'ARCHITECTURE D'ARCHITECTURE DE NANTES
 DOCUMENT SOUMIS AU DROIT D'AUTEUR

